

Canon

EOS R5 Mark II



Advanced User Guide

E

Contents

Introduction.	10
Package Contents.	11
Supplemental Information.	13
Compatible Accessories.	14
Instruction Manuals.	15
Quick Start Guide.	16
About This Guide.	20
Operation of Battery Packs and Power Accessories.	22
Compatible Cards.	24
Safety Instructions.	25
Handling Precautions.	28
Part Names.	31
Software/Apps.	43
Preparation and Basic Operations.	48
Charging the Battery.	49
Inserting/Removing Batteries.	52
Inserting/Removing Cards.	55
Using the Screen.	61
Turning on the Power.	63
Attaching and Detaching RF/RF-S Lenses.	66
Attaching and Detaching EF/EF-S Lenses.	70
Multi-Function Shoe.	74
Using the Viewfinder.	76
Using Eye Control.	80
Basic Operations.	97
Menu Operations and Settings.	114
Quick Control.	120
Touch-Screen Operation.	126
Shooting Mode.	128
A+: Fully Automatic Shooting (Scene Intelligent Auto).	129

A+: Fully Automatic Techniques (Scene Intelligent Auto)	133
Fv: Flexible-Priority AE	135
P: Program AE	138
Tv: Shutter-Priority AE	140
Av: Aperture-Priority AE	143
M: Manual Exposure	146
BULB: Long (Bulb) Exposures	149
Shooting and Recording	153
Still Photo Shooting	154
Tab Menus: Still Photo Shooting	157
Image Quality	162
Still Photo Cropping/Aspect Ratio	169
Auto Exposure Bracketing (AEB)	173
ISO Speed Settings for Still Photos	175
Anti-Flicker Shooting	184
High-Frequency Anti-Flicker Shooting	186
Shooting with Speedlites	192
Flash Function Settings	197
Picture Style Selection	213
Picture Style Customization	217
Picture Style Registration	221
HDR Shooting (PQ)	224
Color Space	225
Clarity	226
Auto Lighting Optimizer	227
Highlight Tone Priority	228
White Balance	229
Custom White Balance	234
White Balance Correction	246
Lens Aberration Correction	250
Long Exposure Noise Reduction	258
High ISO Speed Noise Reduction	259
Dust Delete Data Acquisition	260

Multiple Exposures.	264
Focus Bracketing.	273
Pre-Continuous Shooting.	279
Interval Timer Shooting.	281
Silent Shutter Function.	285
Shutter Mode.	286
Enabling Shutter Release Without a Card.	288
Image Stabilizer (IS Mode).	289
Customizing Quick Controls.	292
Shooting with the Touch Shutter.	295
Image Review.	297
High-Speed Display.	300
Metering Timer.	301
HDR/C. Log View Assist.	302
Display Simulation.	306
Optical Viewfinder Simulation.	308
Blackout-Free Display.	309
Shooting Information Display.	310
Reverse Display.	323
Display Frame Rate.	324
Viewfinder Display Format.	326
Auto Power Off Temperature.	327
Metering Mode Selection.	329
AE for Priority Subjects During AF.	332
Manual Exposure Compensation.	333
Exposure Lock (AE Lock).	335
General Still Photo Shooting.	337
Movie Recording.	340
Tab Menus: Movie Recording.	342
Movie Recording.	347
Movie Recording Size.	363
High Frame Rate.	374
Main Recording Format.	375

Movie Cropping	380
Dual Shooting (Still Photos and Movies)	381
Sound Recording	384
Audio Format	387
Audio Settings	388
Audio Status	395
Custom Pictures	396
HDR Movie Mode	414
Time-Lapse Movies	419
Movie Self-Timer	433
Tally Lamp	434
Pre-Recording Setting	435
Image Stabilizer (IS Mode)	438
Movie Auto Level	441
False Color Settings	442
Zebra Settings	444
Shooting Information Display	446
Quick Control Screen	451
Standby: Low Resolution	452
Canon Log HDMI Output Range	453
Metadata	454
Time Code	459
Other Menu Functions	467
General Movie Recording Precautions	475
AF/Drive	480
Tab Menus: AF (Still Photos)	481
Tab Menus: AF (Movie Recording)	485
AF Operation	488
Movie Servo AF	494
Selecting the AF Area	498
Manual Focus	528
Registering People to Prioritize	535
Servo AF Characteristics	550

Customizing AF Functions.	557
Focus Preset.	576
Selecting the Drive Mode.	577
Using the Self-Timer.	581
Remote Control Shooting.	584
Playback.	586
Tab Menus: Playback.	588
Image Playback.	590
Magnified Image Display.	595
Index Display (Multiple-Image Display).	600
Voice Memo Recording and Playback.	603
Movie Playback.	609
4K/8K Movie Frame Grab.	613
Playback on a TV Set.	616
Protecting Images.	618
Erasing Images.	622
Rotating Still Photos.	629
Changing Movie Orientation Information.	631
Rating Images.	633
Copying Still Photos.	640
Print Ordering (DPOF).	647
RAW Image Processing.	652
In-Camera Upscaling.	661
Resizing JPEG/HEIF Images.	666
Cropping JPEG/HEIF Images.	668
Converting HEIF to JPEG.	671
Slide Show.	676
VR Preview.	679
Setting Image Search Conditions.	681
Resuming from Previous Playback.	684
Blur/Out-of-Focus Image Detection.	685
Customizing Playback Information Display.	691
Displaying the Highlight Alert.	695

AF Point Display.	696
Playback Grid.	697
Movie Play Count.	698
Communication Functions.	700
Tab Menus: Communication Functions.	702
Available Network Features.	704
Preparing to Use Communication Functions.	706
Network-Specific Preparation.	708
Transferring Images to an FTP Server.	711
Connecting to EOS Utility.	751
Uploading Images to image.canon.	764
Syncing Time Between Cameras.	771
Connecting to a Smartphone or Tablet.	778
Live Streaming.	809
Connecting to a Wireless Remote Control.	816
Using Camera Control API (CCAPI).	821
GPS Device Settings.	831
Linked Shooting.	837
Basic Communication Settings.	847
Checking and Editing Network Settings.	891
Airplane Mode.	917
Bluetooth Settings.	918
Renaming the Camera.	919
Reference.	920
Error Details.	921
Responding to Error Messages.	922
Troubleshooting Guide.	935
Wireless Communication Precautions.	936
Security.	938
Checking Network Settings.	939
Wireless Communication Status.	940
Checking the MAC Address.	942
App Selection for USB Connections.	943

Save/Load Communication Settings on Card.	944
Resetting Communication Settings.	948
Set-up.	949
Tab Menus: Set-up.	951
Selecting Cards for Recording/Playback.	955
Folder Settings.	963
Still Photo File Numbering.	967
Movie Clip Numbering.	972
File Naming.	975
Card Formatting.	981
Auto Rotate.	984
Adding Orientation Information to Movies.	986
Date/Time/Zone.	987
Language.	991
System Frequency.	992
Help.	993
Beeps.	996
Volume.	997
Audio Monitor.	998
Screen Brightness.	1004
Viewfinder Brightness.	1005
Screen and Viewfinder Color Tone.	1006
Fine-Tuning Viewfinder Color Tone.	1007
Screen and Viewfinder Display.	1008
UI Magnification.	1009
HDMI Resolution.	1010
Cooling Fan Settings.	1011
Shutter at Shutdown.	1014
Sensor Cleaning.	1015
Power Saving.	1019
Resetting the Camera.	1020
Custom Shooting Mode (C1-C3).	1021
Save/Load Camera Settings on Card.	1024

Battery Information.	1027
Copyright Information.	1034
Other Information.	1037
Control Customization.	1038
Tab Menus: Control Customization.	1039
Control Customization Details.	1042
Custom Functions/My Menu.	1073
Tab Menus: Custom Functions.	1074
Custom Function Setting Items.	1076
Tab Menus: My Menu.	1091
Registering My Menu.	1092
Reference.	1098
Importing Images to a Computer.	1099
Importing Images to a Smartphone.	1103
Using a USB Power Adapter to Charge/Power the Camera.	1106
Using a Battery Grip.	1109
Using a Cooling Fan.	1122
Troubleshooting Guide.	1136
Error Codes.	1155
Information Display.	1156
Specifications.	1175
Trademarks and Licensing.	1225

Introduction

Before starting to shoot, be sure to read the following

To avoid shooting problems and accidents, first read the [Safety Instructions](#) and [Handling Precautions](#). Also read this Advanced User Guide carefully to ensure that you use the camera correctly.

Take some test shots, and understand about product liability

After shooting, play images back and check whether they have been properly recorded. If the camera or memory card is faulty and images cannot be recorded or transferred to a computer, Canon cannot be held liable for any loss or inconvenience caused.

Copyrights

Copyright laws in some countries prohibit the unauthorized use of images recorded with the camera (or music/images with music transferred to the memory card) for purposes other than personal enjoyment.

Also be aware that certain public performances, exhibitions, etc. may prohibit photography even for private enjoyment.

Connecting other devices

Use the included interface cable or a Canon cable when connecting the camera to a computer or other device. When connecting an interface cable, also use the included cable protector (🔒).

- [Package Contents](#)
- [Supplemental Information](#)
- [Compatible Accessories](#)
- [Instruction Manuals](#)
- [Quick Start Guide](#)
- [About This Guide](#)
- [Operation of Battery Packs and Power Accessories](#)
- [Compatible Cards](#)
- [Safety Instructions](#)
- [Handling Precautions](#)
- [Part Names](#)
- [Software/Apps](#)

Package Contents

Before use, make sure the following items are included in the package. If anything is missing, contact your dealer.

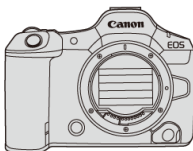

Camera

(with body cap (Camera Cover R-F-5) and shoe cover ER-SC3)



Battery Pack LP-E6P

(with protective cover)

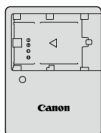

Battery Charger LC-E6/LC-E6E*

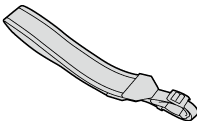

Strap



Interface Cable

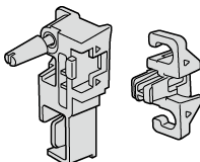

Cable Protector

* Battery Charger LC-E6 or LC-E6E is provided. (The LC-E6E comes with a power cord.)

- The camera does not come with a memory card (🔗) or HDMI cable.
- If you purchased a Lens Kit, check that the lenses are included.
- Be careful not to lose any of these items.
- No software CD-ROM is included. Software (🔗) can be downloaded from the Canon website.
- For details on compatible interface cables, visit the Canon website (🔗).

Caution

- The transmission rate when the included interface cable is used is equivalent to SuperSpeed USB (USB 5Gbps).
- When you need Lens Instruction Manuals, download them from the Canon website (🔗).

Lens Instruction Manuals (PDF files) are for lenses sold separately, and when a lens kit is purchased, some accessories included with the lens may not match those listed in the Lens Instruction Manual.

Supplemental Information

Refer to the following website for information on lenses compatible with camera features, and for supplemental information about the camera.

- <https://cam.start.canon/H001/>



Compatible Accessories

Check the following website for details on compatible accessories.

- <https://cam.start.canon/H002/>



Instruction Manuals

- **Instruction Manual (included with the camera)**

Be sure to read before use.

- **Advanced User Guide**

Complete instructions are provided in this Advanced User Guide. For the latest Advanced User Guide, refer to the following website.

<https://cam.start.canon/C017/>



- **Lens Instruction Manuals**

View or download from the following website.

<https://cam.start.canon/>



For software instruction manuals, see [Software Instruction Manuals](#).

 **Note**

- Select [ **Manual/software URL**] to display the QR code on the camera screen.

Quick Start Guide

1. Insert the battery (🔗).

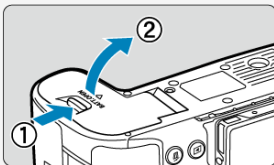

- Upon purchase, charge the battery to start using (🔗).

2. Insert the cards (🔗).

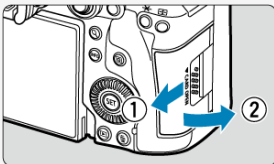

- You can insert two cards.

3. Attach the lens (🔗).

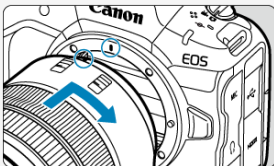

- Align the red mount index on the lens with the red mount index on the camera to attach the lens.

4. Set the focus mode to AF (🔗).

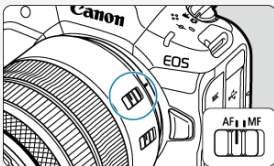

- Set the lens's focus mode switch to < **AF** >.
- For lenses without a focus mode switch, set [**AF: Focus mode**] to [AF].

5. Set the power switch to < ON > (🔗).

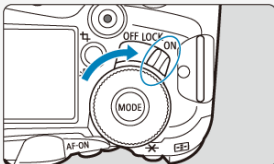

6. Flip out the screen (🔗).

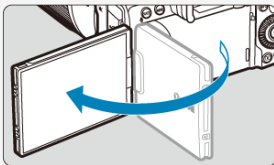

- When the language setting screen is displayed, see [Language](#).
- When the date/time/zone setting screen is displayed, see [Date/Time/Zone](#).
- After [**Welcome**] appears on the screen, follow the on-screen instructions to connect the camera to your smartphone (🔗).

7. Set the shooting mode to [A+] (🔗).

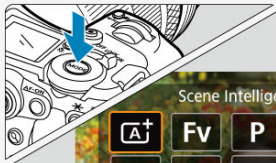

- Press the <MODE> button, then turn the <🔧> dial to select [A+].

8. Focus on the subject (🔗).



- A tracking frame [] appears over any face detected.
- Press the shutter button halfway, and the camera will focus on the subject.

9. Take the picture (🔗).

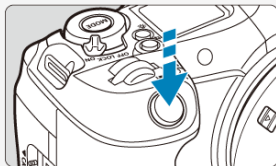

- Press the shutter button completely to take the picture.

10. Review the picture.









- The image just captured will be displayed for approx. 2 sec. on the screen.
- To display the image again, press the < ▶ > button (📷).

About This Guide







 [Icons in This Guide](#)

 [Basic Assumptions for Operational Instructions and Sample Photos](#)

Icons in This Guide

	Indicates the Main dial.
	Indicates Quick control dial 1.
	Indicates Quick control dial 2.
	Indicates the Multi-controller.
	Indicates the lens control ring.
	Indicates the Set button.
	Indicates the duration (in * seconds) of the operation for the button you pressed, as timed after you release the button.

- In addition to the above, the icons and symbols used on the camera's buttons and displayed on the screen are also used in this guide when discussing relevant operations and functionality.

	☆ to the right of titles indicates functions only available in [Fv], [P], [Tv], [Av], [M], or [BULB] mode.
	Links to pages with related topics.
	Warning to prevent shooting problems.
	Supplemental information.
	Tips or advice for better shooting.
	Troubleshooting advice.

Basic Assumptions for Operational Instructions and Sample Photos

- Before following any instructions, make sure the power switch is set to < ON > (🔌) and the Multi-function lock feature is off (🔒).
- It is assumed that all the menu settings and Custom Functions are set to their defaults.
- Illustrations in this guide show the camera with the RF24-105mm F4 L IS USM lens attached as an example.
- Sample photos in this guide are only for illustration.
- In references to using EF or EF-S lenses, it is assumed that a mount adapter is used.

Operation of Battery Packs and Power Accessories

○: Fully functional △: Partially functional ×: Not compatible

● With one power source in the battery grip, or without a battery grip

	Without a Battery Grip	Battery Grip BG-R20	Cooling Fan CF-R20EP	Battery Grip BG-R20EP	Battery Grip BG-R10
Battery Pack LP-E6P	○	○	○	○	△*2*3
Battery Pack LP-E6NH/ LP-E6N	△*2*3	△*2*3	△*2*3*4	△*2*3	△*2*3
Battery Pack LP-E6*1	×	×	×	×	×
DC Coupler DR-E6P	○	○	○	○	△*2*3

● With two power sources in the battery grip

Power Source 1	Power Source 2	Battery Grip BG-R20	Cooling Fan CF-R20EP	Battery Grip BG-R20EP	Battery Grip BG-R10
Battery Pack LP-E6P	Battery Pack LP-E6P	○	○	○	△*2*3
	Battery Pack LP-E6NH/ LP-E6N	△*2*3	△*2*3*4	△*2*3	△*2*3
	Battery Pack LP-E6*1	×	×	×	×
Battery Pack LP-E6NH/ LP-E6N	Battery Pack LP-E6NH/ LP-E6N	△*2*3	△*2*3*4	△*2*3	△*2*3
	Battery Pack LP-E6*1	×	×	×	×
DC Coupler DR-E6P	-	○	○	○	△*2*3

* 1: Cannot be used as a power source.

* 2: Network connectivity (Wi-Fi/wired LAN) not available.

* 3: Reduces continuous shooting speed and prevents selection of 8K DCI/8K UHD/RAW/SRAW movie recording size, Fine image quality, and 239.76/200.00/119.88/100.00/59.94/50.00 fps frame rates.

HDMI RAW output, still photo shooting during movie recording, High Frame Rate movies, and pre-continuous shooting are not available.

* 4: Cooling fan cannot be used.

 **Caution**

- DC Coupler DR-E6 and Wireless File Transmitter WFT-R10 cannot be used.

 **Note**

- With Battery Pack LP-E6NH/LP-E6N loaded or Battery Grip BG-R10 attached, a message about restricted operation is displayed on startup and when unavailable functions are selected.
- For optimal camera performance, use Battery Pack LP-E6P and Battery Grip BG-R20/BG-R20EP.

Compatible Cards

The following cards can be used with the camera. **If the card is new or was previously formatted (initialized) by another camera or computer, format it with this camera** (🔗).

- **CFexpress cards**
* Type-B compatible
- **SD/SDHC/SDXC memory cards**
* UHS-II and UHS-I cards compatible



⚠ Caution

- You cannot use CFexpress cards with a capacity larger than 2TB.

Cards That Can Record Movies

When recording movies, use a CFexpress card that supports VPG400 or a card with ample performance (fast enough writing and reading speeds) for the movie recording quality (🔗).



The VPG-400 Logo is a Certification Mark of CompactFlash Association, used under license.

In this manual, "CFexpress card" refers specifically to CFexpress cards, "SD card" refers to SD/SDHC/SDXC memory cards collectively, and "card" refers to all memory cards in general.

*** A card is not included.** Please purchase it separately.

Safety Instructions

Be sure to read these instructions in order to operate the product safely.
Follow these instructions to prevent injury or harm to the operator of the product or others.

 **WARNING:** Denotes the risk of serious injury or death.

- Keep the product out of the reach of young children.
- Keep batteries out of the reach of children.

A strap wrapped around a person's neck may result in strangulation.

The parts or provided items of cameras or accessories are dangerous if swallowed. If swallowed, seek immediate medical assistance.

The battery is dangerous if swallowed. If swallowed, seek immediate medical assistance.

- **PRODUCT CONTAINS BUTTON/COIN CELL BATTERY**

Button/coin cell batteries are hazardous and must be kept out of reach of children at all times, whether new or used.

These batteries can cause severe or fatal injuries in 2 hours or less if swallowed or placed inside any part of the body.

If it is suspected a button/coin cell battery has been swallowed or placed inside any part of the body, seek medical attention immediately.

- Use only power sources specified in this instruction manual for use with the product.
- Do not disassemble or modify the product.
- Do not expose the product to strong shocks or vibration.
- Do not touch any exposed internal parts.
- Stop using the product in any case of unusual circumstances such as the presence of smoke or a strange smell.
- Do not use organic solvents such as alcohol, benzine or paint thinner to clean the product.
- Do not get the product wet. Do not insert foreign objects or liquids into the product.
- Do not use the product where flammable gases may be present.

This may cause electric shock, explosion or fire.

- Do not leave a lens or a camera/camcorder with a lens attached, exposed without the lens cap attached.

The lens may concentrate the light and cause fire.

- Do not touch the product connected to a power outlet during lightning storms.

This may cause electric shock.

- Observe the following instructions when using commercially available batteries or provided battery packs.
 - Use batteries/battery packs only with their specified product.
 - Do not heat batteries/battery packs or expose them to fire.
 - Do not charge batteries/battery packs using non-authorized battery chargers.
 - Do not expose the terminals to dirt or let them come into contact with metallic pins or other metal objects.
 - Do not use leaking batteries/battery packs.
 - When disposing of batteries/battery packs, insulate the terminals with tape or other means.

This may cause electric shock, explosion or fire.

If a battery/battery pack leaks and the material contacts your skin or clothing, flush the exposed area thoroughly with running water. In case of eye contact, flush thoroughly with copious amounts of clean running water and seek immediate medical assistance.

- Observe the following instructions when using a battery charger or AC adapter.
 - Periodically remove any dust buildup from the power plug and power outlet using a dry cloth.
 - Do not plug in or unplug the product with wet hands.
 - Do not use the product if the power plug is not fully inserted into the power outlet.
 - Do not expose the power plug and terminals to dirt or let them come into contact with metallic pins or other metal objects.
 - Do not touch the battery charger or AC adapter connected to a power outlet during lightning storms.
- Do not place heavy objects on the power cord. Do not damage, break or modify the power cord.
- Do not wrap the product in cloth or other materials when in use or shortly after use when the product is still warm in temperature.
- Do not unplug the product by pulling the power cord.
- Do not leave the product connected to a power source for long periods of time.
- Do not charge batteries/battery packs at temperatures outside the range of 5 - 40 °C (41 - 104 °F).

This may cause electric shock, explosion or fire.

- Do not allow the product to maintain contact with the same area of skin for extended periods of time during use.

This may result in low-temperature contact burns, including skin redness and blistering, even if the product does not feel hot. The use of a tripod or similar equipment is recommended when using the product in hot places and for people with circulation problems or less sensitive skin.

- Follow any indications to turn off the product in places where its use is forbidden.

Not doing so may cause other equipment to malfunction due to the effect of electromagnetic waves and even result in accidents.

- Do not leave batteries near pets.

Pets biting a battery could cause leakage, overheating, or explosion, resulting in product damage or fire.



CAUTION:

Follow the cautions below. Otherwise physical injury or property damage may result.

- Do not fire the flash near the eyes.

It may hurt the eyes.

- Do not look at the screen or through the viewfinder for prolonged periods of time.

This may induce symptoms similar to motion sickness. In such a case, stop using the product immediately and rest for a while before resuming use.

- Flash emits high temperatures when fired. Keep fingers, any other part of your body, and objects away from the flash unit while taking pictures.

This may cause burns or malfunction of the flash.

- Do not leave the product in places exposed to extremely high or low temperatures.

The product may become extremely hot/cold and cause burns or injury when touched.

- Strap is intended for use on the body only. Hanging the strap with any product attached on a hook or other object may damage the product. Also, do not shake the product or expose the product to strong impacts.

- Do not apply strong pressure on the lens or allow an object to hit it.

This may cause injury or damage to the product.

- Only mount the product on a tripod that is sufficiently sturdy.

- Do not carry the product when it is mounted on a tripod.

This may cause injury or may result in an accident.

- Do not touch any parts inside the product.

This may cause injury.

- If any abnormal skin reaction or irritation occurs during or following the use of this product, refrain from further use and get medical advice/attention.



- **Do not touch the screen storage compartment (A), because its temperature can increase** by repeated continuous shooting for extended time or movie recording. This may cause burns.

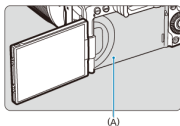

- The camera and memory cards may become hotter when  **Auto pwr off temp.** is set to **[High]**.
 - We recommend using a tripod or the like to avoid handheld shooting, which may cause problems such as low-temperature contact burns.
 - Do not touch CFexpress cards immediately after shooting. Cards may be hot, which may cause burns. Wait until the card has cooled down before removing it.

Handling Precautions

Camera care

- This camera is a precision instrument. Do not drop it or subject it to physical shock.
- The camera is not waterproof and cannot be used underwater.
- To maximize the camera's dust- and drip- resistance, keep the terminal cover, battery compartment cover, card slot cover, and all other covers firmly closed. Also attach the shoe cover to the multi-function shoe.
- This camera is designed to be dust- and drip- resistant, in order to help prevent sand, dust, dirt, or water that falls on it unexpectedly from getting inside, but it is impossible to prevent dirt, dust, water, or salt from getting inside at all. As far as possible, do not allow dirt, dust, water, or salt to get on the camera.
- If water gets on the camera, wipe it off with a dry and clean cloth. If dirt, dust, or salt gets on the camera, wipe it off with a clean, well-wrung wet cloth.
- Using the camera in dusty or dirty locations may lead to damage.
- Cleaning the camera after use is recommended. Allowing dirt, dust, water, or salt to remain on the camera may cause a malfunction.
- If you accidentally drop the camera into water or are concerned that moisture (water), dirt, dust, or salt may have gotten inside it, promptly consult the nearest Canon Service Center.
- Never leave the camera near anything having a strong magnetic field such as a magnet or electric motor. Also, avoid using or leaving the camera near anything emitting strong radio waves, such as a large antenna. Strong magnetic fields can cause camera malfunction or destroy image data.
- Do not leave the camera in excessive heat, such as in a car in direct sunlight. High temperatures can cause the camera to malfunction.
- The camera contains precision electronic circuitry. Never attempt to disassemble the camera yourself.
- Do not block shutter curtain operation with your finger or other objects. Doing so may cause a malfunction.
- Only use a commercially available blower to blow away dust on the lens, viewfinder, or other parts. Do not use cleaners that contain organic solvents to clean the camera body or lens. For stubborn dirt, take the camera to the nearest Canon Service Center.
- Do not touch the camera's electrical contacts with your fingers. This is to prevent the contacts from corroding. Corroded contacts can cause camera malfunction.
- If the camera is suddenly brought in from the cold into a warm room, condensation may form on the camera and internal parts. To prevent condensation, first put the camera in a sealed plastic bag and let it adjust to the warmer temperature before taking it out of the bag.
- If condensation forms on the camera, to avoid damage, do not use the camera or remove the lens, card, or battery. Turn the camera off and wait until the moisture has fully evaporated before resuming use. Even after the camera is completely dry, if it is still internally cold, do not remove the lens, card, or battery until the camera has adjusted to the ambient temperature.
- If the camera will not be used for an extended period, remove the battery and store the camera in a cool, dry, well-ventilated location. Even while the camera is in storage, press the shutter button a few times once in a while to check that the camera is still working.

- Avoid storing the camera where there are chemicals that result in rust and corrosion such as in a chemical lab.
- If the camera has not been used for an extended period, test all its functions before using it. If you have not used the camera for some time or if there is an important shoot such as a foreign trip coming up, have the camera checked by your nearest Canon Service Center or check the camera yourself and make sure it is working properly.
- The camera may become hot after repeated continuous shooting or still photo/movie shooting over an extended period. This is not a malfunction.
- If there is a bright light source inside or outside the image area, ghosting may occur.
- When shooting with backlighting, keep the sun sufficiently away from the angle of view. Always keep intense light sources such as the sun, lasers, and other intense artificial light sources out of the image area and not near it. Concentrated intense light may cause smoke or damage the image sensor or other internal components.
- Attach the lens cap to prevent direct sunlight and other light from entering the lens when you are not shooting.

Screen and viewfinder, LCD panel

The following does not affect images captured by the camera.

- Although the screen and viewfinder are manufactured with very high precision technology with over 99.99% effective pixels, 0.01% or fewer of the pixels may be dead, and there may also be spots of black, red, or other colors. This is not a malfunction. They do not affect the images recorded.
- If the screen is left on for a prolonged period, screen burn-in may occur where you see remnants of what was displayed. However, this is only temporary and will disappear when the camera is left unused for a few days.
- The screen display may seem slightly slow in low temperatures or may look black in high temperatures. It will return to normal at room temperature.

Cards

To protect the card and its recorded data, note the following:

- Do not drop, bend, or wet the card. Do not subject it to excessive force, physical shock, or vibration.
- Keep card contacts free of dust and foreign material. Do not touch card contacts with your fingers or metal objects.
- Do not affix any stickers, etc. on the card.
- Do not store or use the card near anything that has a strong magnetic field, such as a television, speakers, or magnets. Also avoid places prone to having static electricity.
- Do not leave the card in direct sunlight or near a heat source.
- Store the card in a case.
- Do not store the card in hot, dusty, or humid locations.
- Cards may become hot after long sessions of repeated continuous shooting or still photo shooting/movie recording. This is not a malfunction.

Lens

- After detaching the lens from the camera, put down the lens with the rear end up and attach the rear lens cap to avoid scratching the lens surface and electrical contacts (1).

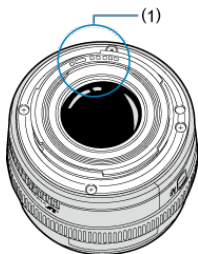

Smudges on the image sensor

Besides dust entering the camera from outside, in rare cases, lubricant from the camera's internal parts may adhere to the front of the sensor. If smudges are visible on images, have the sensor cleaned by a nearest Canon Service Center.

Battery

Tips for using the battery and charger



- Store in a cool, dry, well-ventilated location.
- When storing the battery for extended periods, charge it about once a year. When charging the battery, aim to charge it to approx. 50% instead of fully charging it (🔋).
- At room temperature (23°C/73°F), it takes approx. 60 min. to charge a depleted battery to about approx. 50%. Battery charging time varies greatly depending on ambient temperature.
- If the battery is not used for an extended period, the trace amount of current that continues to flow inside the battery when it is removed from the camera may eventually lead to over-discharge and prevent further use, even after charging.

Part Names

[Attaching the Strap](#)

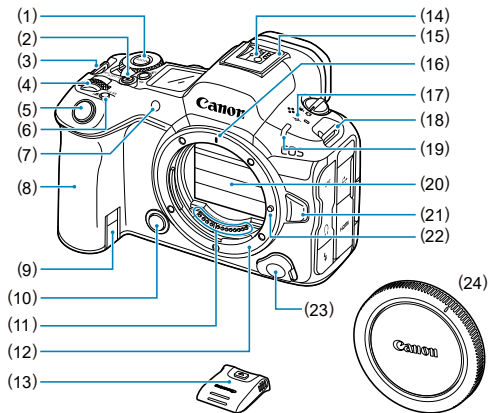
[Using the Cable Protector](#)



(1)	< MODE > Mode button
(2)	Movie shooting button
(3)	Strap mount
(4)	<  > Main dial
(5)	Shutter button
(6)	< M-Fn /  > Multi-function/FTP server image transfer button
(7)	Self-timer lamp/AF-assist beam
(8)	Grip (battery compartment)
(9)	DC coupler cord hole
(10)	Depth-of-field preview button
(11)	Contacts
(12)	Lens mount
(13)	Shoe cover
(14)	Flash sync contacts
(15)	Multi-function shoe
(16)	RF lens mount index
(17)	<  > Focal plane mark
(18)	Strap mount
(19)	Tally lamp
(20)	Shutter curtain/Image sensor
(21)	Lens release button
(22)	Lens lock pin
(23)	Remote control terminal
(24)	Body cap

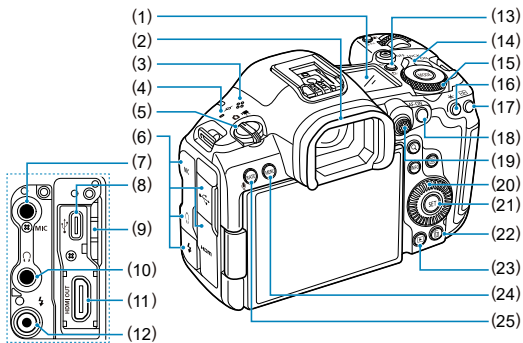

(1)	LCD panel
(2)	Eyecup
(3)	Speaker
(4)	Microphone
(5)	< / > Still photo shooting/movie recording switch
(6)	Terminal cover
(7)	< MIC > External microphone IN terminal
(8)	< > Digital terminal
(9)	Exhaust vent
(10)	< > Headphone terminal
(11)	< HDMI OUT > HDMI OUT terminal
(12)	< > Sync terminal
(13)	< / > LCD panel info switching/illumination/cropping button
(14)	Power/multi-function lock switch
(15)	< > Quick control dial 2
(16)	< > AE lock button
(17)	< > AF point selection button
(18)	< AF-ON > AF start button
(19)	< > Multi-controller (can also be pressed straight in)
(20)	< > Quick control dial 1
(21)	< > Set button
(22)	< > Erase button
(23)	< > Playback button
(24)	< MENU > Menu button
(25)	< RATE / > Rating/voice memo button

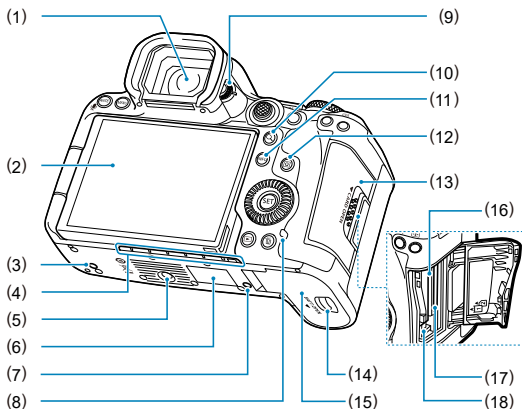

- | | |
|------|--------------------------------|
| (1) | Viewfinder eyepiece |
| (2) | Screen |
| (3) | Accessory positioning hole |
| (4) | Intake vent |
| (5) | Tripod socket |
| (6) | Serial number (body number) |
| (7) | Accessory positioning hole |
| (8) | Access lamp |
| (9) | Dioptic adjustment knob |
| (10) | <Q> Magnify/reduce button |
| (11) | <INFO> Info button |
| (12) | <Q> Quick Control button |
| (13) | Card slot cover |
| (14) | Battery compartment cover lock |
| (15) | Battery compartment cover |
| (16) | Card slot 1 |
| (17) | Card slot 2 |
| (18) | Card eject button |

LCD panel information display



Information displayed varies depending on camera status. For icon details, see [Information Display](#).

Viewfinder information display

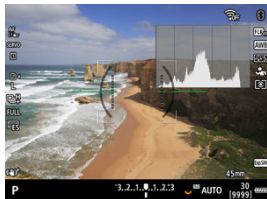

Information displayed varies depending on camera status.

Battery Charger LC-E6

Charger for Battery Pack LP-E6P/LP-E6NH/LP-E6N/LP-E6 (🔗).

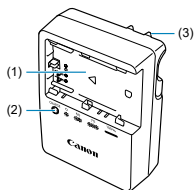

(1) Battery slots

(2) Charge lamp

(3) Power plug

Battery Charger LC-E6E

Charger for Battery Pack LP-E6P/LP-E6NH/LP-E6N/LP-E6 (☑).

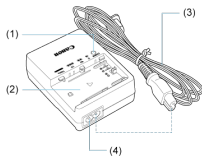

-
- | | |
|-----|-------------------|
| (1) | Charge lamp |
| (2) | Battery pack slot |
| (3) | Power cord |
| (4) | Power cord socket |
-

Attaching the Strap

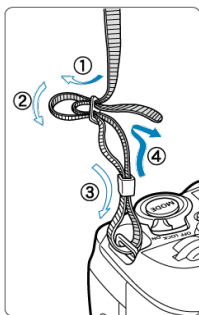

Pass the end of the strap through the strap mount from the bottom, then pass it through the strap buckle as shown. Pull the strap to take up any slack and make sure the strap will not loosen from the buckle.

Using the Cable Protector

When connecting cables (an interface cable or HDMI cable), use the included cable protector. Using the cable protector helps prevent accidental disconnection and terminal damage.

- When connecting the camera to a computer, use a Canon cable (included or sold separately).
- When connecting the camera to a television or other display device, use a commercially available HDMI cable.

Preparation

1. Prepare the cable protector.

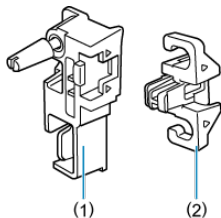

- The cable protector consists of the protector (1) and a clamp (2).

2. Attach the protector to the camera.

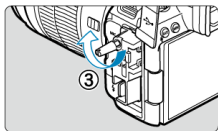
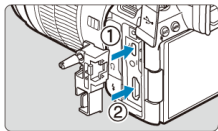

Cable insertion/connection

Insert the cables in the clamp, attach the clamp to the protector, then connect the cables to the camera.

With both a Canon interface cable and an HDMI cable

1. Pass each cable through the clamp.

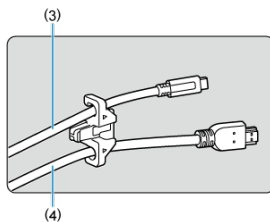

(3) Canon interface cable

(4) HDMI cable

2. Attach the clamp to the protector.

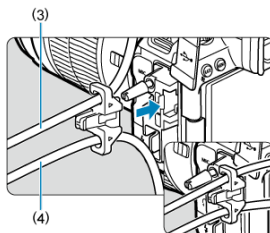

3. Connect each cable to the camera.

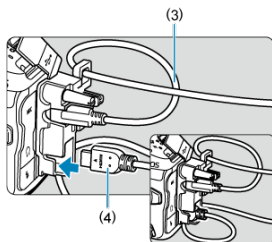

With only a Canon interface cable or HDMI cable

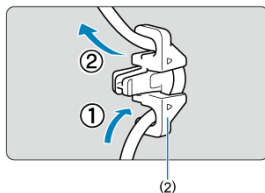

Pass the cable through the clamp (2) as shown, then attach the clamp to the protector.

⚠ Caution

- Using the camera when an interface cable or HDMI cable is connected without the cable protector may damage the camera terminal. Make sure each cable is securely connected to the camera terminal.

Software/Apps

- [✔ Software/App Overview](#)
- [✔ Installing Computer Software](#)
- [✔ Installing Smartphone Apps](#)
- [✔ Software Instruction Manuals](#)

Software/App Overview

Computer software

- **EOS Utility**
Enables you to transfer captured images from the camera to a connected computer, set various camera settings from the computer, and shoot remotely from the computer.
- **Digital Photo Professional**
Software recommended for users who shoot RAW images. Enables image viewing, editing, printing, and more.
- **Neural network Image Processing Tool**
For RAW image processing with superior image quality, applying deep learning. Requires a paid subscription.
- **Neural network Upscaling Tool**
For JPEG/TIFF upscaling, applying deep learning. Requires a paid subscription.
- **Picture Style Editor**
Enables you to edit existing Picture Styles or create and save original Picture Style files.
- **Cinema RAW Development**
For RAW movie processing, playback, and exporting.
- **Canon XF Utility**
For transferring movie files to a computer, as well as playback and still photo extraction.
- **Canon RAW Plugin for Avid Media Access**
For importing RAW movies into Avid Media Composer.
- **Canon RAW Plugin for Final Cut Pro**
For importing RAW movies into Apple Final Cut Pro.

- **Canon Plugin for ProRes RAW**

For importing RAW movies recorded with Atomos recorders in ProRes RAW format into Apple Final Cut Pro.

Smartphone apps

- **Camera Connect**

Enables you to transfer captured images from the camera to a smartphone over a wired or wireless connection, set various camera settings from the smartphone, and shoot remotely from the smartphone.

- **Digital Photo Professional Express**

App for RAW image processing and image editing on a smartphone or tablet. Requires a paid subscription.

- **Content Transfer Professional**

Enables FTP transfer and other operations for captured images or images on a smartphone. Requires a paid subscription.

Installing Computer Software

Always install the latest version of the software. In this case, previous versions are overwritten.

Caution

- Do not install software while the camera is connected to the computer. The software will not be installed correctly.
- Installation is not possible without an internet connection.
- Older versions of the software do not support RAW image processing or correct display for images from this camera.

1. Download the software.

- Connect to the internet from a computer and access the following Canon website.
<https://cam.start.canon/>

Depending on the software, you may need to enter the camera's serial number. The serial number is on the bottom of the camera.

2. Extract the installer on the computer.

For Windows

- Click the displayed installer file to start the installer.

For macOS

- Double-click the dmg file to open the installation window.
- Double-click the icon in this window to start the installer.

3. Follow the on-screen instructions to install the software.

Installing Smartphone Apps

- Always install the latest version.
- Apps can be installed from Google Play or App Store.
- You can also access Google Play and App Store from the following Canon website.
<https://cam.start.canon/>



Check the following website for software instruction manuals.

- <https://cam.start.canon/>



Preparation and Basic Operations

This chapter describes preparatory steps before you start shooting and the basic camera operations.

- [Charging the Battery](#)
- [Inserting/Removing Batteries](#)
- [Inserting/Removing Cards](#)
- [Using the Screen](#)
- [Turning on the Power](#)
- [Attaching and Detaching RF/RF-S Lenses](#)
- [Attaching and Detaching EF/EF-S Lenses](#)
- [Multi-Function Shoe](#)
- [Using the Viewfinder](#)
- [Using Eye Control](#)
- [Basic Operations](#)
- [Menu Operations and Settings](#)
- [Quick Control](#)
- [Touch-Screen Operation](#)

Charging the Battery

1. Detach the protective cover provided with the battery.

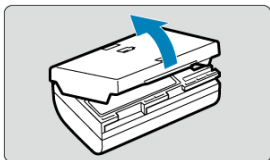

2. Fully insert the battery into the charger.

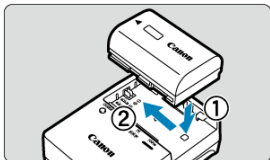

- Do the opposite to remove the battery.

3. Charge the battery.

LC-E6

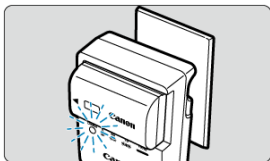
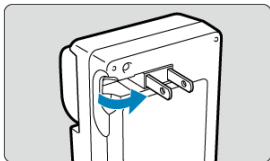

- Flip out the charger prongs as shown and plug the charger into a power outlet.

LC-E6E

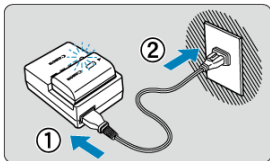



- Connect the power cord to the charger and insert the plug into a power outlet.
- Recharging starts automatically and the charge lamp blinks in orange.

Charge Level	Charge Lamp	
	Color	Display
0–49%	Orange	Blinks once per second
50–74%		Blinks twice per second
75% or higher		Blinks three times per second
Fully charged	Green	Turned on

- **Charging a depleted battery takes approx. 3 hr. at room temperature (23°C/73°F).**
The time required to charge the battery will vary greatly depending on the ambient temperature and the battery's remaining capacity.
- For safety, charging in low temperatures (5–10°C/41–50°F) takes longer (up to approx. 4 hr.).
- **Upon purchase, the battery is not fully charged.**
Charge the battery before use.
- **Charge the battery on the day before or on the day it is to be used.**
Charged batteries gradually lose their charge, even when they are not used.
- **After charging the battery, remove it and disconnect the charger from the power outlet.**
- **You can attach the protective cover in a different orientation to indicate whether the battery is charged or not.**

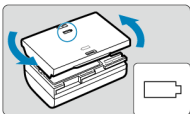
If the battery is charged, attach the provided protective cover so that the battery-shaped hole <  > is aligned over the blue sticker on the battery. If the battery is exhausted, attach the protective cover in the opposite orientation.



- **When not using the camera, remove the battery.**
If the battery is left in the camera for a prolonged period, a small amount of power current will keep being released, resulting in excess discharge and shorter battery life. Store the battery with the protective cover attached. Storing the battery when it is fully charged may lower the battery performance.
- **The battery charger can also be used in foreign countries.**
The battery charger is compatible with a 100 V AC to 240 V AC 50/60 Hz power source. If necessary, attach a commercially available plug adapter for the respective country or region. To avoid damage, do not connect to portable voltage transformers.
- **If the battery becomes exhausted quickly even after having been fully charged, the battery has reached the end of its service life.**
Check the battery's recharge performance () and purchase a new battery.

Caution

- After disconnecting the charger's power plug, do not touch the prongs for approx. 10 sec.
- If the battery's remaining capacity () is 94% or higher, the battery will not be charged.
- The provided charger cannot charge any battery other than Battery Pack LP-E6P/LP-E6NH/LP-E6N/LP-E6.

Inserting/Removing Batteries

 [Insertion](#)

 [Removal](#)

Insert a fully charged Battery Pack LP-E6P into the camera.

Insertion

1. Slide the battery compartment cover lock and open the cover.

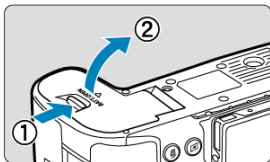

2. Insert the battery.

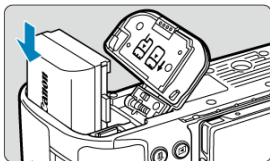

- Insert the end with the electrical contacts.
- Insert the battery until it locks in place.
- For details on compatible battery packs, see [Operation of Battery Packs and Power Accessories](#).

3. Close the cover.

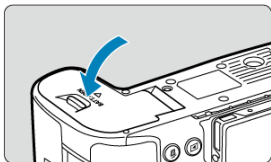

- Press the cover until it snaps shut.

1. Open the cover and remove the battery.

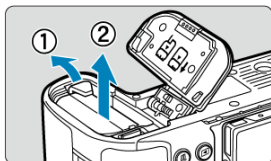

- Press the battery lock lever as shown by the arrow and remove the battery.
- To prevent short-circuits, always attach the included protective cover (☑) to the battery.

Inserting/Removing Cards

[✔ Insertion](#)

[✔ Formatting Cards](#)

[✔ Removal](#)

This camera accepts two cards. **Recording is possible as long as there is at least one card in the camera.**

With two cards inserted, you can select one card to record to, or you can record the same image to both cards at once (✔).

⚠ Caution

- **Make sure the SD card's write-protect switch (1) is set upward to enable writing and erasing.**

Insertion

1. Slide the cover to open it.

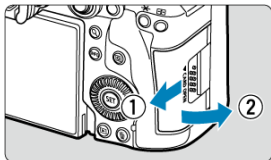

- Pull the card slot cover toward you to open it.

2. Insert the card.

Card 1 (CFexpress card)

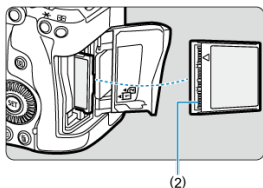

Card 2 (SD card)

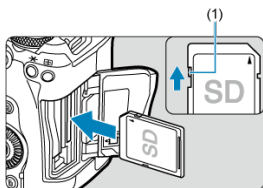

- The card in the rear card slot is [1] (CFexpress card), and the one in front of it is [2] (SD card).
- CFexpress card: With the card label facing you, insert the open side of the card (2) into the card slot. **Inserting cards the wrong way may damage the camera.**
- The gray card-eject button pops out.
- SD card: With the card label facing you, insert the card into the card slot until it clicks into place.

3. Close the cover.

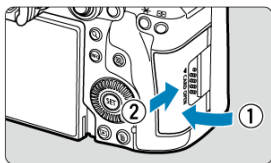

- Close the cover and slide it as shown until it clicks shut.

4. Set the power switch to < ON > (☑).

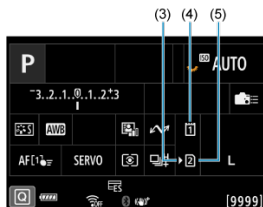

- (3) Card selection icon
 - (4) Card 1 (CFexpress card)
 - (5) Card 2 (SD card)
- Icons representing loaded cards are shown on the shooting screen (☑) accessed by pressing the < INFO > button and on the Quick Control screen (☑). **The camera will record to cards shown with a card selection icon [◀ ▶].**

Formatting Cards

If a card is new or was previously formatted (initialized) by another camera or computer, format the card with this camera (🔗).

1. Open the cover.

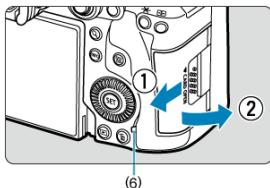

- Set the power switch to < OFF > and **make sure the access lamp (6) is off.**
- Pull the card slot cover toward you to open it.
- If [Saving...] is displayed on the screen, close the cover.

2. Remove the card.

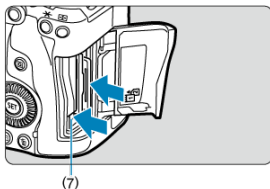

- CFexpress card: Press the card eject button (7) to eject the card.
- SD card: Gently press the card in, then release it to eject it.
- Pull the card straight out, then close the cover.

Caution

Do not remove cards immediately after a red [🔥] icon is displayed as you are shooting. Cards may be hot, due to high internal camera temperature. Set the power switch to < OFF > and stop shooting for a while before removing cards. Removing hot cards immediately after shooting may cause you to drop and damage them. Be careful when removing cards.

Note

- The number of shots available varies depending on remaining card capacity and settings such as image quality and ISO speed.
- Setting [📷: Release shutter without card] to [Disable] will prevent you from forgetting to insert a card (🔗).

Caution

- **When the access lamp is lit or blinking, it indicates that images are being written to, read from, or erased from the card, or data is being transferred. Do not open the card slot cover during this time. To avoid corrupting image data or damaging cards or the camera, never do any of the following while the access lamp is lit or blinking.**
 - Removing the card.
 - Removing the battery.
 - Shaking or striking the camera.
 - Unplugging or plugging in a power cord
(when using optional household power outlet accessories).
- If the card already contains recorded images, the image number may not start from 0001 (🔗, 🔗).
- If a card-related error message is displayed on the screen, remove and reinsert the card. If the error persists, use a different card.
If you can transfer images on the card to a computer, transfer all the images and then format the card with the camera (🔗). The card may then return to normal.
- Do not touch the card's contacts with your fingers or metal objects. Do not expose the contacts to dust or water. If smudges adhere to the contacts, contact failure may result.
- Multimedia cards (MMC) cannot be used. (Card error will be displayed.)
- Use of UHS-II microSDHC/SDXC cards with a microSD to SD adapter is not recommended.
When using UHS-II cards, use SDHC/SDXC cards.

Using the Screen

You can change the direction and angle of the screen.

1. Flip out the screen.

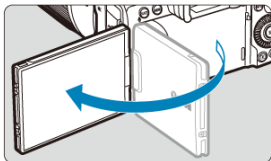

2. Rotate the screen.

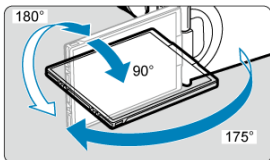

- When the screen is out, you can tilt it up or down or rotate it to face the subject.
- Indicated angles are only approximate.

3. Face it toward you.



- Normally, use the camera with the screen facing you.

 **Caution**

- Avoid forcing the screen into position as you rotate it, which puts undue pressure on the hinge.
- When a cable is connected to a camera terminal, the rotation angle range of the flipped-out screen will be limited.

 **Note**

- Keep the screen closed and facing the camera body when the camera is not in use. You can protect the screen.
- A mirror image (right/left reversed) of subjects is displayed when the screen faces subjects in front of the camera.

Turning on the Power

- [Changing the Interface Language](#)
- [Setting the Date, Time, and Time Zone](#)
- [Connecting the Camera to a Smartphone](#)
- [Automatic Sensor Cleaning](#)
- [Battery Level Indicator](#)

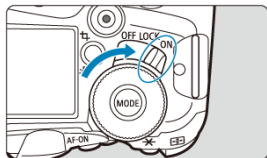

- **< ON >**
The camera turns on.
- **< LOCK >**
The camera turns on. Multi-function locking is engaged () .
- **< OFF >**
The camera is turned off and does not function. Set the power switch to this position when not using the camera.

Note

- If you set the power switch to **< OFF >** while an image is being recorded to the card, **[Saving...]** will be displayed and the power will turn off after the recording finishes.

Changing the Interface Language

Set the [Language](#) if the [Language] setting screen appears after you turn on the camera.

Setting the Date, Time, and Time Zone

Set the [Date/Time/Zone](#) if the [Date/Time/Zone] setting screen appears.

Connecting the Camera to a Smartphone

Instructions for connecting to a smartphone are displayed if you select [OK] when the setup screen appears (🔗).

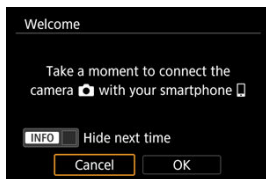

Automatic Sensor Cleaning

- Whenever the power switch is set to < OFF >, the sensor is cleaned automatically (which may make a faint sound). During the sensor cleaning, the screen will display [🔧]. To enable automatic sensor cleaning when the power switch is set to < ON > as well, you can set this in [🔧: Sensor cleaning] (🔗).
- If you repeatedly turn the power switch to < ON/LOCK > or < OFF > within a short time period, the [🔧] icon may not be displayed, but this does not indicate the camera is malfunctioning.

Battery Level Indicator

When the power switch is set to <ON>, the battery level will be indicated.

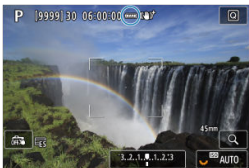

Display						
Level (%)	100-70	69-50	49-20	19-10	9-1	0

Caution

- Remaining capacity may not be displayed correctly under some shooting conditions.
- Battery performance may decrease at low temperatures. Under these conditions, keep the camera warm in a pocket or similar container until you will use it. At this time, keep your pocket free of metal objects such as key chains. Contact with metal objects may short-circuit the battery.
- Doing any of the following will exhaust the battery faster:
 - Pressing the shutter button halfway for a prolonged period.
 - Activating the AF frequently without taking a picture.
 - Using Image Stabilizer.
 - Using Wi-Fi features.
 - Using the screen frequently.
 - Using accessories compatible with the multi-function shoe.
- The number of available shots may decrease depending on the actual shooting conditions.
- Lens operations are powered by the camera's battery. Certain lenses may exhaust the battery faster than others.
- In low ambient temperatures, shooting may not be possible even with a sufficient battery level.

Note

- See [**Battery info.**] to check the battery status ().

Attaching and Detaching RF/RF-S Lenses

 [Attaching a Lens](#)

 [Detaching a Lens](#)

Caution

- Do not look at the sun directly through any lens. Doing so may cause loss of vision.
- When attaching or detaching a lens, set the camera's power switch to <OFF>.
- If the front part (focusing ring) of the lens rotates during autofocusing, do not touch the rotating part.

Tips for avoiding smudges and dust

- When changing lenses, do it quickly in a place with minimal dust.
- When storing the camera without a lens attached, be sure to attach the body cap to the camera.
- Remove smudges and dust on the body cap before attaching it.

Note

- With RF-S lenses, an approx. 1.6× crop factor is applied to the center of the regular image area.

Attaching a Lens

1. Remove the caps.

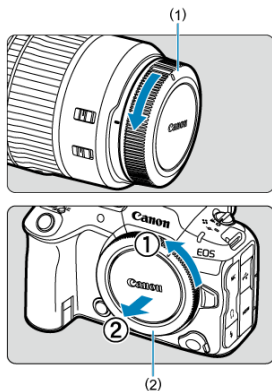

- Remove the rear lens cap (1) and body cap (2) by turning them as shown by the arrows.

2. Attach the lens.

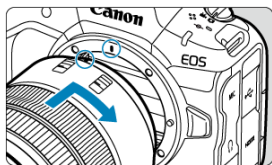

- Align the red mount index on the lens with the red mount index on the camera and turn the lens as shown by the arrow until it clicks in place.

3. Set the focus mode to AF.

- AF stands for autofocus.
- MF stands for manual focus. Autofocus is disabled.
- **For RF lenses with a focus mode switch**
Set the lens's focus mode switch to < AF >.

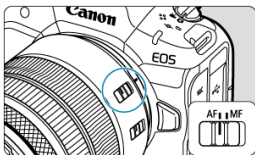

- **For RF lenses without a focus mode switch**
Set [**AF**: Focus mode] to [AF].

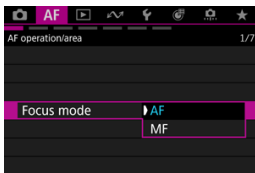

4. Remove the front lens cap.

Detaching a Lens

While pressing the lens release button, turn the lens as shown by the arrow.

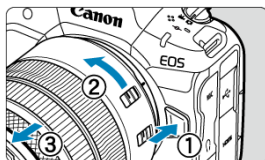

- Turn the lens until it stops, then detach it.
- Attach the rear lens cap to the lens you removed.

Attaching and Detaching EF/EF-S Lenses

 [Attaching a Lens](#)

 [Detaching a Lens](#)

All EF and EF-S lenses can be used by attaching an optional Mount Adapter EF-EOS R.
The camera cannot be used with EF-M lenses.

Note

- With EF-S lenses, an approx. 1.6× crop factor is applied to the center of the regular image area.

Attaching a Lens

1. Remove the caps.

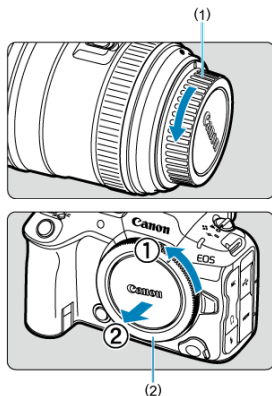

- Remove the rear lens cap (1) and body cap (2) by turning them as shown by the arrows.

2. Attach the lens to the adapter.

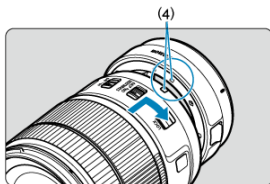
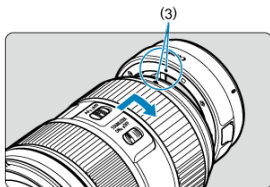

- Align the red or white mount index on the lens with the corresponding mount index on the adapter and turn the lens as shown by the arrow until it clicks into place.

(3) Red index

(4) White index

3. Attach the adapter to the camera.

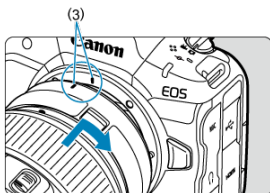

- Align the red mount indexes (5) on the adapter and camera and turn the lens as shown by the arrow until it clicks into place.

4. Set the lens's focus mode switch to <AF>.

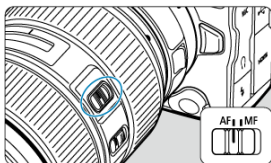

- <AF> stands for autofocus.
- <MF> stands for manual focus. Autofocus will not operate.

5. Remove the front lens cap.

Detaching a Lens

1. While pressing the lens release button, turn the adapter as shown by the arrow.

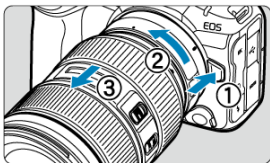

- Turn the lens until it stops, then detach it.

2. Detach the lens from the adapter.

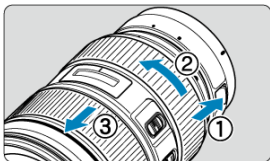

- Hold down the lens release lever on the adapter and turn the lens counterclockwise.
- Turn the lens until it stops, then detach it.
- Attach the rear lens cap to the lens you removed.

Caution

- For lens precautions, see [Attaching and Detaching RF/RF-S Lenses](#).

Multi-Function Shoe

[Using the Multi-Function Shoe](#)

The multi-function shoe is a hot shoe that supplies power to accessories and offers advanced communication functionality.

Using the Multi-Function Shoe

Removing the shoe cover

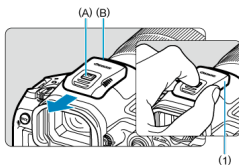

- Place your finger on the shoe cover (1) as shown in the figure and press down on part (A) as you pull the cover off in the direction shown. If removal is difficult, try pulling the cover off with a finger placed on part (B).
- After removal, keep the shoe cover in a convenient place to avoid losing it.

Attaching accessories

- When attaching accessories that communicate through contacts of the multi-function shoe, insert the accessory's mounting foot until it clicks into place, then slide the mounting foot locking lever to secure it. For details, refer to the accessory's Instruction Manual.
- The following accessories cannot be attached directly to the multi-function shoe.
 - Speedlite EL-1/600EXII-RT/600EX-RT/580EX II
 - Speedlite Transmitter ST-E3-RT (Ver. 2)/ST-E3-RT
 - Off-Camera Shoe Cord OC-E3
 - GPS Receiver GP-E2
- To use the accessories listed above with the camera, you will need Multi-Function Shoe Adapter AD-E1, sold separately. For details, refer to the AD-E1 Instruction Manual.
- When attaching accessories other than these that are designed for regular hot shoes, insert the accessory's mounting foot all the way in, then slide the mounting foot locking lever to secure it. For details, refer to the accessory's Instruction Manual.
- Electronic Viewfinder EVF-DC2/EVF-DC1 cannot be attached to the multi-function shoe. Attempting to attach the accessories by force may damage them or the multi-function shoe.

Attaching the shoe cover

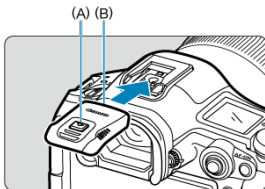

- After removing accessories from the multi-function shoe, reattach the shoe cover to protect the contacts from dust and water.
- Slide the shoe cover in the direction shown, as you press down on part (A), until part (B) is fully inserted.

Caution

- Attach accessories correctly as described in [Attaching accessories](#). Incorrect attachment may cause the camera or accessories to malfunction, and accessories may fall off.
- Blow off any foreign material on the multi-function shoe with a commercially available blower or similar tool.
- If the multi-function shoe becomes wet, turn off the camera and allow it to dry before use.
- Use the shoe cover included with the camera.

Using the Viewfinder

 [Dioptric Adjustment](#)

 [Using Eyecup ER-kE \(Sold Separately\)](#)

Look through the viewfinder to activate it. You can also restrict display to either the screen or viewfinder ().

Dioptric Adjustment

Adjust the diopter for clear viewfinder display.

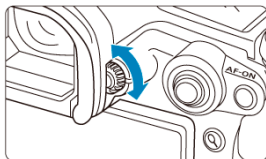

- Turn the dioptic adjustment knob left or right.

Caution

- The viewfinder and screen cannot be activated at the same time.
- At some aspect ratios, black bars are displayed on the top and bottom or left and right edges of the screen. These areas are not recorded.

Using Eyecup ER-kE (Sold Separately)

Outdoors, using Eyecup ER-kE may improve eye control accuracy and viewfinder visibility.

1. Attach Eyecup ER-kE.

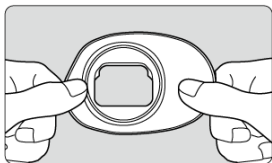

- Hold Eyecup ER-kE as shown in both hands.

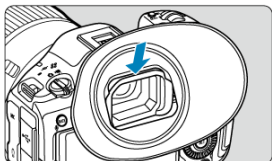

- Insert the side of Eyecup ER-kE with ▼ markings into the groove around the camera eyecup, then press down from above until the accessory is fully attached.

⚠ Caution

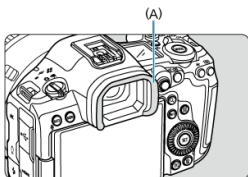

- When attaching Eyecup ER-kE, avoid pinching the edge of the camera eyecup (A). With this edge pinched, Eyecup ER-kE can easily come off.

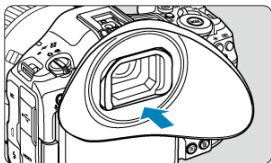

- With Eyecup ER-kE fully inserted, press the lower part toward the camera.

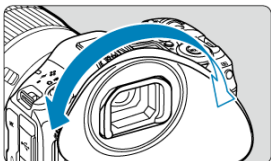

- You can rotate Eyecup ER-kE as necessary for adjustment. It clicks every 90° and can be rotated 360°.

2. To remove Eyecup ER-kE:

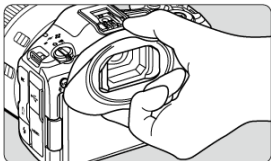

- Press firmly on the top and bottom of Eyecup ER-kE.

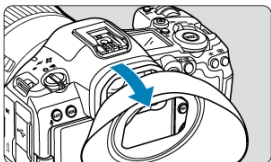

- Pull the top toward you and remove it from the camera eyecup.
- Note that the rubber part may come off if pulled too forcefully.

Caution



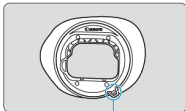

- Speedlites or similar accessories cannot be attached or removed while Eyecup ER-kE is attached. Remove Eyecup ER-kE temporarily before attaching or removing other accessories.
- The dioptic adjustment knob cannot be operated while Eyecup ER-kE is attached. Adjust the diopter before attaching Eyecup ER-kE.

Note



- Eyecup ER-kE has a strap mount (B) to prevent the eyecup from being dropped. Pass a commercially available strap through (B) and the camera strap or other parts to secure it.

Using Eye Control

-  [Performing Calibration](#)
-  [Using Eye Control for AF](#)
-  [Configuring Pointer Display](#)
-  [Managing Calibration Data](#)

You can control focusing by looking at AF points to select them in viewfinder shooting (eye control).

Caution

- Eye control is only available in still photo shooting.

Performing Calibration

The process of registering characteristics of your line of sight for accurate detection of eye movement by the camera in viewfinder shooting is called calibration. Calibration enables higher eye control accuracy.

Points to know before calibration

Be aware of the following points before calibration.

- It may not be possible to detect your line of sight if you are squinting. If so, open your eye or eyes wider as you look at the viewfinder.
- It may not be possible to detect your line of sight if your eye is too close to the viewfinder. If so, keep your eye a little farther from the viewfinder. Using Eyecup ER-kE (sold separately) makes it easier to detect your line of sight.
- During calibration, keep looking at indicators until they disappear completely.
- Eye control may be less accurate if your eye is off-center, relative to the viewfinder. Adjust how you are holding the camera to your face, so that the four corners of the screen appear evenly spaced.
- Eye control may be less accurate if you point the camera downward during calibration. Hold the camera straight when performing calibration.

Note

- Also read [General eye control precautions](#) and [Enhancing eye control accuracy](#).

Calibration operations

After adjusting the viewfinder (👁️), perform calibration under the same conditions as when you will shoot (such as with or without glasses or contact lenses). During calibration, keep your eye near the viewfinder.

1. Select [👁️: Eye control▶️] (👁️).
2. Select [Calibration (CAL)].

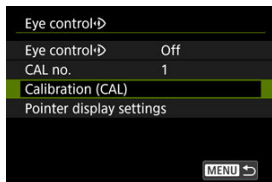

- Calibration results (calibration data) are saved to the current [CAL no.] number.

3. Select [Start].

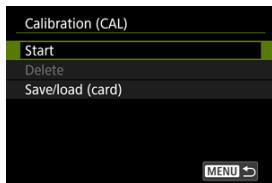

4. Look through the viewfinder.



- Holding the camera horizontally, look through the viewfinder so that the four corners of the screen appear evenly spaced.
- Press the < M-Fn > button.

5. Start calibration.

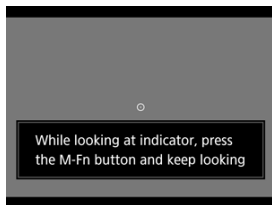

- Look at the indicator displayed and press the < M-Fn > button.
- Keep looking at the indicator without blinking until it disappears.
- This process is repeated for indicators at five positions (center, right, left, top, and bottom).

6. Perform calibration for vertical shooting.



- For higher eye control accuracy, select [**Refine**] and perform calibration for vertical shooting.
- Holding the camera vertically, look through the viewfinder so that the four corners of the screen appear evenly spaced, then repeat step 5.
- If you will also shoot vertically with the camera grip facing the other direction, perform calibration while holding the camera that way.
- To finish calibration after performing calibration only for horizontal shooting, go to step 7.

7. Exit calibration.



- Select [**Exit**]. Calibration results (calibration data) are saved to the calibration number shown in step 2.

8. Verify pointer movement.

- After calibration, look through the viewfinder and make sure the pointer moves in response (👁️). If the pointer does not seem to follow your gaze closely, perform calibration again.

Adding calibration data

To register calibration data for other users or eyewear conditions (such as with or without glasses or contact lenses), select an available number to assign the data to from the numbers labeled with  on the [CAL no.] screen, then perform calibration.

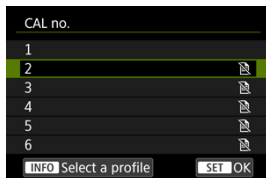

Using Eye Control for AF



Caution

- Always use eye control under the same eyewear conditions as when you performed calibration (such as with or without glasses or contact lenses).

Note

- Also read [General eye control precautions](#) and [Enhancing eye control accuracy](#).

Menu settings

1. Select [**Eye control**] (: Eye control) (.
2. Select [**Eye control**].

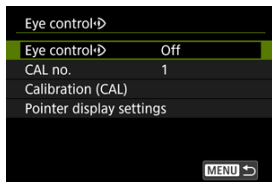

3. Select [**On**].

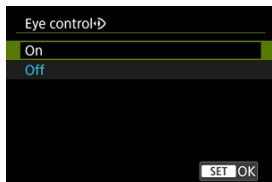

- You can enable switching between [**Eye control**] [**On**] and [**Off**] from the Quick Control screen by customizing the Quick Control screen (.

4. Select [CAL no.].

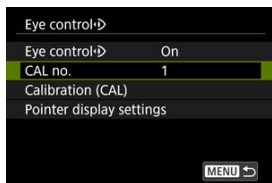

- Select a calibration number matching your eyewear conditions (such as with or without glasses or contact lenses).

5. Select calibration data to use.

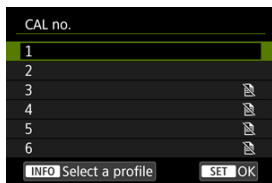

- Press <  >.

Operations in viewfinder shooting

1. Look at the subject.

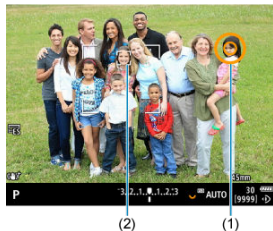

- A pointer (1) is displayed when you look through the viewfinder.
- After the subject set in **[AF: Subject to detect]** is detected, a tracking frame [] (2) is also displayed.
- Look at the position where you wish to focus.
- The pointer may stop moving unless the camera can follow your eye movement. If so, hold the camera away from your face for a moment, then look through the viewfinder again so that the four corners of the screen appear evenly spaced.

2. Confirm the subject to start focusing.

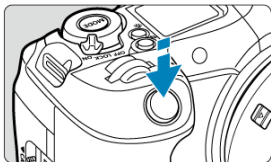

- Pressing the shutter button halfway confirms the subject to focus on.
- With **[AF: AF area]** set to **[Whole area AF]**, the camera focuses in the area near the pointer.
With the AF area set to an option other than **[Whole area AF]**, the camera focuses after moving the AF area near the pointer.

With **[AF: AF operation]** set to **[SERVO]**



(3)

- The active AF point (3) is displayed in blue.
- As long as you hold down the shutter button halfway, the camera keeps tracking and focusing on the confirmed subject, so there's no need for you to keep following it with your eye.
- To switch to another subject to track, first stop tracking the confirmed subject by pressing **<SET>**, then look at the new subject and hold down the shutter button halfway.
- With **[AF: AF area]** set to **[Whole area AF]**, the camera keeps tracking and focusing on confirmed subjects even when you release the shutter button after holding it down halfway. To stop tracking confirmed subjects, press **<SET>**.

With [**AF**: AF operation] set to [ONE SHOT]

- Once the subject is in focus, the AF point turns green.
- Pressing the shutter button halfway sets the focus on the current position.

3. Shoot.

- Press the shutter button completely to take the picture.

Caution

- If the AF point does not move to your specified position after you confirm the subject, hold the camera away from your face, then look through the viewfinder again, or perform calibration again.

Note

- You can assign eye control subject confirmation (**[Move AF point by eye control]**) and AF activation (**[Metering and AF start]**) to different buttons in [: **Customize buttons for shooting**].

Using eye control to display the focus guide

By setting [**AF: Focus guide**] to [**On**], you can use eye control to display the focus guide for assistance when focusing manually.

1. Look at the subject.

- Look at the subject to focus on.

2. Press the shutter button halfway.



(4)

- The focus guide (4) is displayed where you are looking.
- For details on using the focus guide to focus, see [Focus Guide](#).

Note

- A tracking frame [] is also displayed after the subject set in [**AF: Subject to detect**] is detected.

General eye control precautions

- When multiple people will use eye control on the same camera, each person should select a different calibration number and perform calibration. Similarly, when the same person will use eye control with and without glasses or contact lenses, a different calibration number should be selected and calibration performed for each situation.
- When using Eyecup ER-kE (sold separately), select a different calibration number and perform calibration.
- Keep your eye steady relative to the camera, with sunlight or other light blocked out and the four corners of the screen appearing evenly spaced.
- Calibration or eye control may not be possible in the following cases.
 - When hard contact lenses are worn
 - When color contact lenses are worn
 - When you have had eye surgery or other medical treatment
 - When special eyewear is worn, such as near-infrared blocking, mirrored, or bifocal glasses or sunglasses
 - When a mask is worn
 - When your eye is too far from the viewfinder
 - When your eye is too close to the viewfinder
 - When your eye is too misaligned with the viewfinder
 - When the viewfinder or your eyewear is dirty
 - When the viewfinder is fogged up
 - When your contact lenses are not fully in contact with your eyes
 - When sunlight is shining directly into the viewfinder
- Less responsive viewfinder display under low light may make eye control more difficult to use.

Enhancing eye control accuracy

The camera can learn about eye characteristics from the calibration data it collects.

- Eye control accuracy can be improved by repeating calibration under various levels of brightness (such as indoors, outdoors, during the day, and at night) for the same calibration number.
- To use eye control in each camera orientation, repeat calibration for the same calibration number with the camera held horizontally and vertically with the grip up and down.
- Keep the following tips in mind when performing calibration or using eye control.
 - Look into the viewfinder so that the four corners of the screen appear evenly spaced.
 - Look at the subject.
 - Avoid squinting.
 - Avoid blinking.
 - During calibration, look through the viewfinder as you do when shooting.
 - If you use glasses, wear them correctly.
 - In calibration outdoors, prevent sunlight from entering the viewfinder.
 - Use Eyecup ER-kE (sold separately, ).
 - Block out sunlight, to the extent possible, by keeping your face close to the viewfinder.
 - If it is difficult to perform calibration or eye control correctly, try keeping both eyes open as you look through the viewfinder.
- Eye control accuracy can also be improved with the data collected from repeated calibration (2–3 times) for the same calibration number even under the same brightness and with the camera in the same position.

Configuring Pointer Display

You can configure pointer display, including whether the pointer is visible or not.

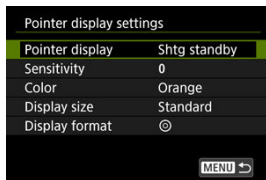

● Pointer display

Pointer visibility can be set to **[On]**, **[Shtg standby]**, or **[Off]**.

- Select **[Shtg standby]** to keep the pointer visible from when you look through the viewfinder until the moment you confirm the subject to focus on using eye control.
- In **[MF]** focus mode, setting **[AF: Focus guide]** to **[On]** makes the pointer visible.

● Sensitivity

Sensitivity of the pointer in response to eye movement is adjustable.

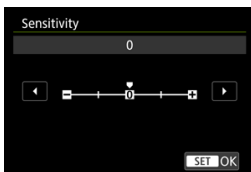

- Set toward the positive end to make the pointer responsive even to subtle eye movement.
- Set toward the negative end to make the pointer less responsive.

● Color

Choose **[Orange]**, **[Purple]**, or **[White]** as the pointer color.

● Display size

Choose **[Standard]** or **[Small]** as the pointer display size.

● Display format

Choose **[⊙]** or **[☺]** as the style of pointer displayed.

Entering names

You can enter names to identify calibration data.

1. Select a calibration data number.

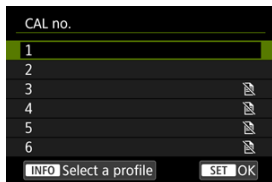

- Select the number and press the <INFO> button.

2. Enter text.

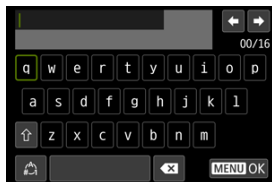

- Use the <⦿> or <☺> dial or <✱> to select a character, then press <SET> to enter it.
- By selecting [☺], you can change the input mode.
- To delete single characters, select [✱] or press the <☹> button.
- When you are finished entering text, press the <MENU> button and select [OK].

Saving and loading calibration data

Registered calibration data can be saved to a card. You can also load calibration data from a card to use it.

1. Select [Calibration (CAL)].

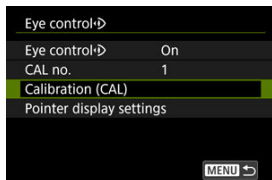

2. Select [Save/load (card)].

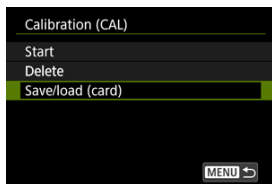

3. Select [Save to card].

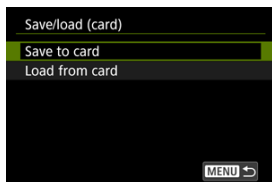

- Select [**Save to card**] to save all calibration data on the camera to the card.
- Select [**Load from card**] to overwrite calibration data on the camera with calibration data from the card.

Deleting calibration data

Eye control is less accurate if the same calibration number is used for calibration under different eyewear conditions (such as with or without glasses or contact lenses) or by multiple users. In this case, delete the calibration data and perform calibration again.

1. Select [Calibration (CAL)].

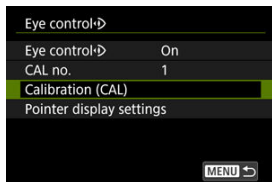

2. Select [Delete].

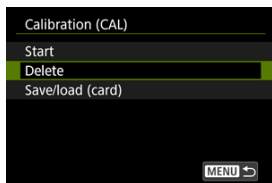

3. Delete the calibration data.

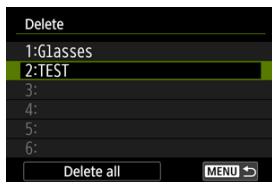

- Select the data to delete and press < (SET) >.
- To delete all calibration data, select [Delete all] and press < (SET) >.
- After you select [OK] on the confirmation screen, the data is deleted.

Basic Operations

- [Holding the Camera](#)
- [Shutter Button](#)
- [< !\[\]\(3da2b303d29c1ea489bbe26a3f5ac664_img.jpg\) > Main Dial](#)
- [< !\[\]\(9421cea5a5b5319f79b58962509475ab_img.jpg\) > Quick Control Dial 1](#)
- [< !\[\]\(17cce402a0380c36f25e02ecf91578f5_img.jpg\) > Quick Control Dial 2](#)
- [< !\[\]\(1086da34995924f924c8e8e23387d139_img.jpg\) > Multi-Controller](#)
- [< **MODE** > Mode Button](#)
- [< **M-Fn** / !\[\]\(ffa6dd4cd8800071ccc1a355540c540c_img.jpg\) > Multi-Function/FTP Server Image Transfer Button](#)
- [< **AF-ON** > AF Start Button](#)
- [< **LOCK** > Multi-Function Lock Switch](#)
- [< !\[\]\(dfba61b58454dd961d978e324a1fb5e5_img.jpg\) / !\[\]\(9580d03b8c5bd7e23dc602a02886460d_img.jpg\) / !\[\]\(406c76dc95713637836155a54c3b56d5_img.jpg\) > LCD Panel Info Switching/Illumination/Cropping Button](#)
- [< !\[\]\(b950fe96ed6737d8544db83990032195_img.jpg\) > Control Ring](#)
- [< **INFO** > Info Button](#)

Holding the Camera

● Viewing the screen as you shoot

As you shoot, you can tilt the screen to adjust it. For details, see [Using the Screen](#).



- (1) Normal angle
- (2) Low angle
- (3) High angle

● Shooting through the viewfinder

To obtain sharp images, hold the camera still to minimize camera shake.

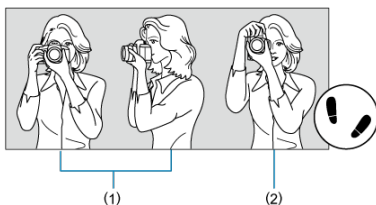

- (1) Horizontal shooting
- (2) Vertical shooting

1. With your right hand, hold the camera firmly by the camera grip.
2. With your left hand, support the lens from below.
3. Rest your right index finger lightly on the shutter button.
4. Rest your arms and elbows lightly against the front of your body.
5. To maintain a stable stance, place one foot slightly ahead of the other.
6. Hold the camera near your face and look through the viewfinder.

Shutter Button

The shutter button has two steps. You can press the shutter button halfway. Then you can further press the shutter button completely.

Pressing halfway

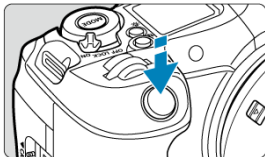

This activates autofocus and the automatic exposure system that sets the shutter speed and aperture value.

The exposure value (shutter speed and aperture value) is displayed on the screen, in the viewfinder, or on the LCD panel for 8 sec. (metering timer/ \odot 8).

Pressing completely

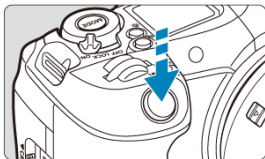

This releases the shutter and takes the picture.

Preventing camera shake

Hand-held camera movement during the moment of exposure is called camera shake. It can cause blurred pictures. To prevent camera shake, note the following:

- Hold the camera still, as shown in [Holding the Camera](#).
- Press the shutter button halfway to autofocus, then slowly press the shutter button completely.



Note

- The camera will still pause before taking a picture if you press the shutter button completely without pressing it halfway first, or if you press the shutter button halfway and immediately press it completely.
- Even during menu display or image playback, you can return to shooting standby by pressing the shutter button halfway.

(1) After pressing a button, turn the <  > dial.

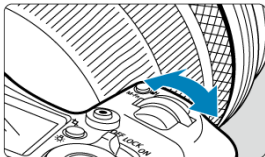
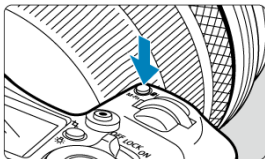

Press a button such as < **MODE** > or < **M-Fn** >, then turn the <  > dial.

If you press the shutter button halfway, the camera will go back to shooting standby.

- After the < **MODE** > button is pressed, the dial is used to select a shooting mode.
- After the < **M-Fn** > button is pressed, the dial is used to set the white balance, drive mode,* flash exposure compensation,* or Picture Style.

* Available only in still photo shooting.

(2) Turn only the <  > dial.

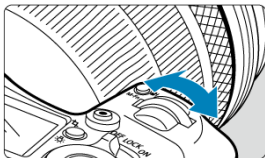

Turn the <  > dial while looking at the screen, viewfinder, or LCD panel.

- Use this dial to set the shutter speed, aperture value, etc.

 **Note**

- The operations in (1) can be performed even when controls are locked with the Multi-function lock ().

(1) After pressing a button, turn the <  > dial.

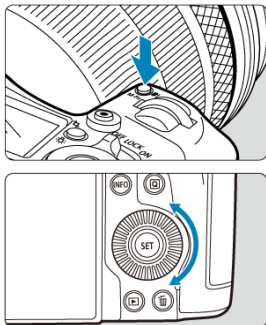



Press a button such as < **MODE** > or < **M-Fn** >, then turn the <  > dial.
If you press the shutter button halfway, the camera will go back to shooting standby.

- After the < **MODE** > button is pressed, the dial is used to select a shooting mode.
- After the < **M-Fn** > button is pressed, the dial is used to set the metering mode,* AF operation,* ISO speed,* or AF area.

* Available only in still photo shooting.

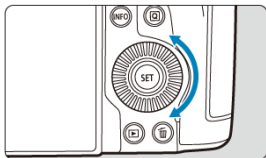
(2) Turn only the <  > dial.



Turn the <  > dial while looking at the screen, viewfinder, or LCD panel.

- Used for operations such as setting the exposure compensation amount and the aperture value setting for manual exposures.



Note

- The operations in (1) can be performed even when controls are locked with the Multi-function lock (🔒).

(1) After pressing a button, turn the <  > dial.

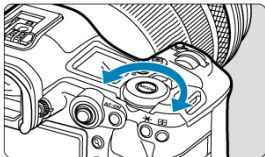
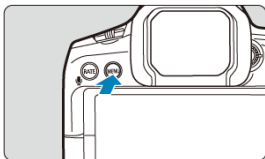

Press a button such as **MENU**, then turn the <  > dial.
If you press the shutter button halfway, the camera will go back to shooting standby.

- Used for operations such as switching between main tabs on the menu screen.

(2) Turn only the <  > dial.

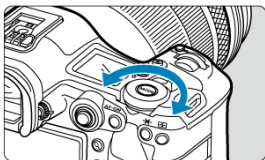

Turn the <  > dial while looking at the screen, viewfinder, or LCD panel.

- Used for operations such as setting the ISO speed.

 **Note**

- The operations in (1) can be performed even when controls are locked with the Multi-function lock ().

< * > Multi-Controller

< * > is an eight-direction key with center button. To use it, press lightly with the tip of your thumb.

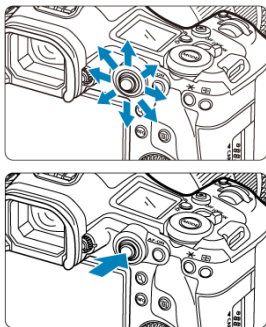



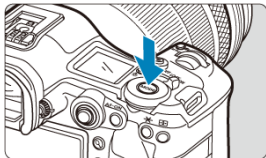

- Examples of using the Multi-controller
 - AF point/magnified frame movement in still photo shooting or movie recording
 - White balance correction
 - Magnified area position movement during playback
 - Quick Control
 - Selecting or setting menu items

<MODE> Mode Button

You can set the shooting mode.



- Press the <MODE> button, then use <  >, <  >, <  >, or <  > to select a shooting mode.







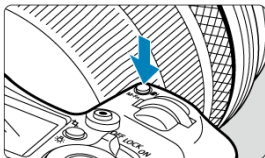

<M-Fn/ > Multi-Function/FTP Server Image Transfer Button

Shooting screen

By default, the <M-Fn> button works in conjunction with dials to enable you to adjust settings used in shooting or recording.







Settings you can configure in conjunction with dials

- White balance ()
- Drive mode* ()
- Flash exposure compensation* ()
- Picture Style ()
- Metering mode* ()
- AF operation* ()
- ISO speed ()
- AF area ()

* Available only in still photo shooting.

How to use with dials

- Press the <M-Fn> button to display the settings you can configure with dials (6).
- Press the <M-Fn> button again repeatedly (or turn the < > dial) to select a setting to configure.
- To adjust the upper row of setting items, turn the < > dial.
- To adjust the lower row of setting items, turn the < > dial.

Caution

- Advanced white balance settings such as color temperature cannot be configured this way.



Note

- To set the AF area, you can also press the <  > button and then the < M-Fn > button.

Playback screen



Pressing the <  > button on the playback screen transfers images to the FTP server.

< AF-ON > AF Start Button

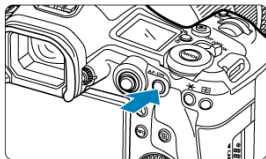
Equivalent to pressing the shutter button halfway (except in [A+] mode).



<LOCK> Multi-Function Lock Switch

Configuring [: **Multi function lock**] () and setting the power/multi-function lock switch to <LOCK> prevents settings from being changed by accidentally touching the Main dial, Quick control dials, Multi-controller, control ring, or touch-screen panel.

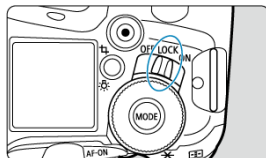



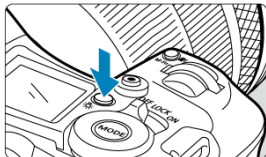

< ☼ / 𠄎 > LCD Panel Info Switching/Illumination/Cropping Button

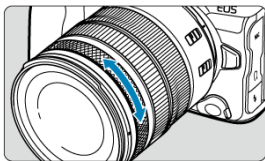

- Each press of the < ☼ > button changes the information on the LCD panel.
- Illuminate the LCD panel by holding down the < ☼ > button (☼6).
- Pressing the < 𠄎 > button on the playback screen switches to [▶]: **Cropping** settings.

< > Control Ring



By default, exposure compensation can be set by turning the control ring of RF lenses or mount adapters while pressing the shutter button halfway in **[Fv]**, **[P]**, **[Tv]**, **[Av]**, or **[M]** mode. Otherwise, you can assign a different function to the control ring by configuring **[]** in **[]: Customize dials/control ring** (****).

<INFO> Info Button

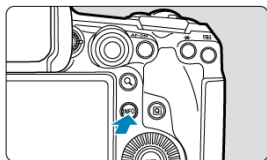

Each press of the <INFO> button changes the information shown.

The following sample screens are for still photos. (5) and (6) are not shown in the viewfinder.

(1)



(2)



(6)



(3)



(5)

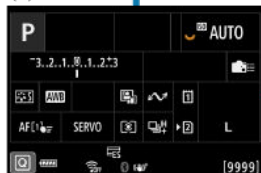

(4)

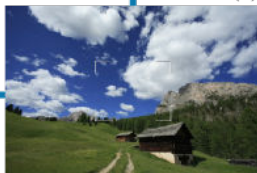

Menu Operations and Settings

- [Menu Screen in \[A+\] Mode](#)
- [Menu Screen in \[Fv\]/\[P\]/\[Tv\]/\[Av\]/\[M\]/\[BULB\] Mode](#)
- [Menu Setting Procedure](#)
- [Dimmed Menu Items](#)

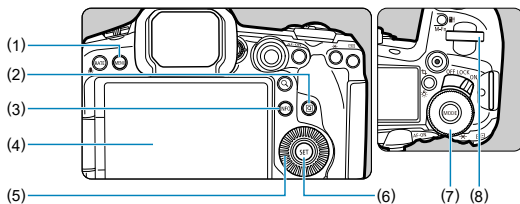

-
- | | |
|-----|--------------------------|
| (1) | <MENU> button |
| (2) | <Q> button |
| (3) | <INFO> button |
| (4) | Screen |
| (5) | <Q> Quick control dial 1 |
| (6) | <Q> button |
| (7) | <Q> Quick control dial 2 |
| (8) | <Q> Main dial |
-

Menu Screen in [A+] Mode

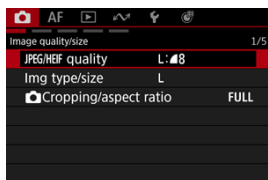

- In [A+] mode, some tabs and menu items are not displayed.

Menu Screen in [Fv]/[P]/[Tv]/[Av]/[M]/[BULB] Mode

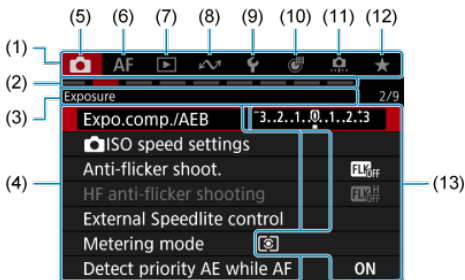

- (1) Main tabs
- (2) Secondary tabs
- (3) Secondary tab name
- (4) Menu items
- (5) : Shooting
- (6) **AF**: Autofocus
- (7) : Playback
- (8) : Communication functions
- (9) : Set-up
- (10) : Control customization
- (11) : Custom Functions
- (12) : My Menu
- (13) Menu settings

Menu Setting Procedure

1. Press the **<MENU>** button.

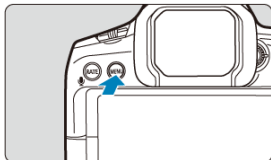

- The menu is displayed.

2. Select a tab.

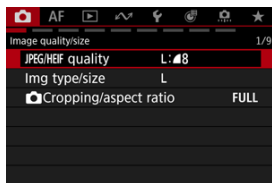

- Each time you turn the **<Q>** dial, the main tab (group of functions) will switch. You can also switch tabs by pressing the **<Q>** button.
- Turn the **<Q>** dial to select a secondary tab.

3. Select an item.

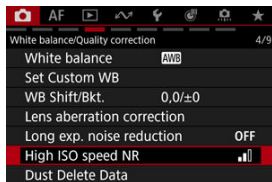

- Turn the **<Q>** dial to select an item, then press **<SET>**.

4. Select an option.

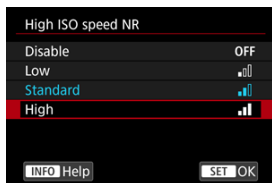

- Turn the <  > dial to select an option.
- The current setting is indicated in blue.

5. Set an option.

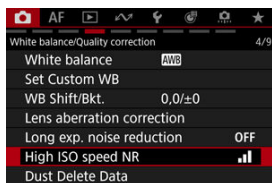

- Press <  > to set it.

6. Exit the setting.

- Press the < MENU > button to return to shooting standby.

Note

- The description of menu functions hereafter assumes that you have pressed the < MENU > button to display the menu screen.
- Menu operations are also possible by tapping the menu screen or using < * >.
- To cancel the operation, press the < MENU > button.

Dimmed Menu Items

Example: When focus bracketing has been set

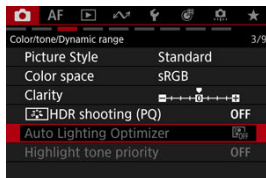

Dimmed menu items cannot be set. Use of these items has been limited by other functions that have been set.

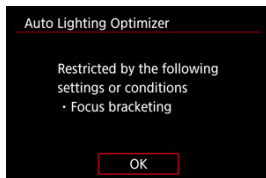

To investigate the limiting function, select a dimmed item and press \langle (SET) \rangle . Canceling the limiting function will enable you to configure the dimmed menu item.

Caution

- It may not be possible to check the limiting function for some setting items.

Note

- In [**F**: **Reset camera**], you can reset menu functions to the default settings by selecting [**Basic settings**] in [**Reset individual settings**] ().

Quick Control

[Quick Control in Still Photo Shooting or Playback](#)

[Quick Control in Movie Recording](#)

You can directly and intuitively select and set the settings displayed.





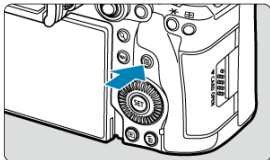



Quick Control in Still Photo Shooting or Playback

1. Press the  button (ⓘ10).







2. Select a setting item and set your preferred option.

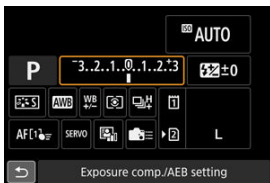

- To select an item, turn the  dial or press  up or down.
- To adjust the setting, turn the  or  dial, or press  left or right. Some items are set by pressing a button after this.
- You can customize the setting items on the screen shown above in **[📷: Customize Quick Controls]** .
- To access the Customize Quick Controls screen, press and hold the  button .



- Press  vertically or horizontally to select an item on the screen shown above.
- To adjust the setting, turn the , , or  dial. Some items are set by pressing a button after this.

Quick Control in Movie Recording

As in still photo shooting, press the <Q> button to access the Quick Control screen. Each press of the <Q> button switches between screens if you have selected ([✓]) both [Display 1] and [Display 2] in [📷: Quick Ctrl screen] (☑), but only the selected screen is displayed if one is selected ([✓]).





Movie recording screen

Use the [Display 1] screen as described in [Quick Control in Still Photo Shooting or Playback](#). Use the [Display 2] screen as follows.

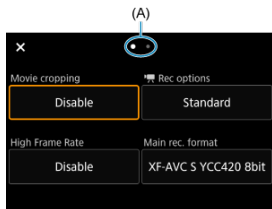

1. Switch pages as needed.



- Turn the <  > or <  > dial to switch pages.
- You can also switch pages by tapping (A) or swiping left or right.

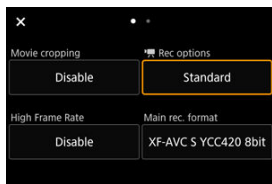



2. Select an item.

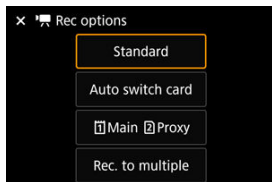

- Turn the <  > dial or press <  > vertically or horizontally to select an item, then press the <  >.



3. Select an option.



- To select an option, turn the <  >, <  >, or <  > dial or press <  > up or down (or in some cases, left or right).

Detailed settings screen



- Turn the <  > dial to select a tab (1).
- Press <  > vertically or horizontally to change the setting (2).
- Press <  > to confirm your selection and return to the screen in step 2.

4. Set an option.

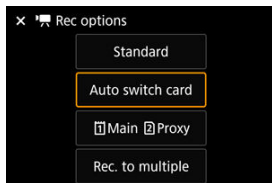

- Press <  > to set it.

5. Exit the setting.

- Press the <  > button to return to shooting standby.

Touch-Screen Operation

[Tapping](#)

[Dragging](#)

Tapping

Sample screen (Quick Control)

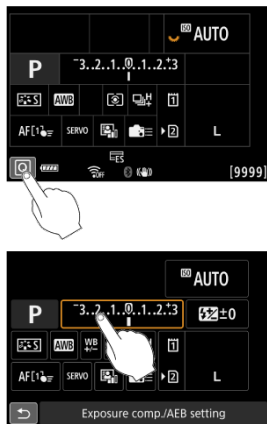

- Use your finger to tap (touch briefly and then remove your finger from) the screen.
- For example, when you tap [Q], the Quick Control screen appears. By tapping [Q], you can return to the preceding screen.

Note

- To have the camera beep for touch operations, set [Beep] to [Enable].
- Responsiveness to touch operations can be adjusted in [Touch control].

Dragging

Sample screen (Menu screen)

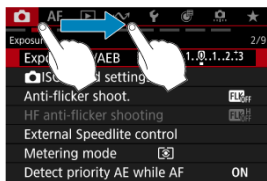

- Slide your finger while touching the screen.

Shooting Mode

This chapter describes shooting modes.

- [A+: Fully Automatic Shooting \(Scene Intelligent Auto\)](#)
- [A+: Fully Automatic Techniques \(Scene Intelligent Auto\)](#)
- [Fv: Flexible-Priority AE](#)
- [P: Program AE](#)
- [Tv: Shutter-Priority AE](#)
- [Av: Aperture-Priority AE](#)
- [M: Manual Exposure](#)
- [BULB: Long \(Bulb\) Exposures](#)

A+: Fully Automatic Shooting (Scene Intelligent Auto)

[A+] is a fully automatic mode. The camera analyzes the scene and sets the optimum settings automatically. It can also adjust focus automatically on either the still or moving subject by detecting the motion of the subject.

1. Set the shooting mode to [A+].



- Press the <MODE> button, then turn the < [Sun] > dial to select [A+].

2. Aim the camera at what you will shoot (the subject).

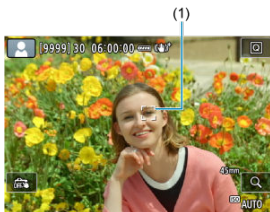

- A tracking frame (1) may be displayed on the subject, under some shooting conditions.

3. Focus on the subject.

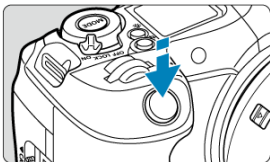

- Press the shutter button halfway to focus.
- You can also focus by tapping a person's face or other subject on the screen (Touch AF).
- Under low light, the AF-assist beam (☑) is automatically activated if needed.
- Once the subject is in focus, that AF point turns green and the camera beeps (One-Shot AF).
- An AF point in focus on a moving subject turns blue and tracks subject movement (Servo AF).

4. Take the picture.

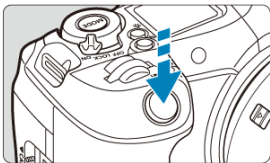

- Press the shutter button completely to take the picture.
- The image just captured will be displayed for approx. 2 sec. on the screen.

Caution



- Subject movement (whether subjects are still or moving) may not be detected correctly for some subject or shooting conditions.





Note

- AF operation (One-Shot AF or Servo AF) is set automatically when you press the shutter button halfway. Note that AF operation cannot be switched during shooting.
- mode makes the colors look more impressive in nature, outdoor, and sunset scenes. If you prefer other color tones, set the shooting mode to **[Fv]**, **[P]**, **[Tv]**, **[Av]**, or **[M]** and select a Picture Style other than before shooting .

Minimizing blurred photos

- Be careful about camera shake in handheld shots. To avoid camera shake, consider using a tripod. Use a sturdy tripod that can bear the weight of the shooting equipment. Attach the camera securely to the tripod.
- Using a remote switch (sold separately, ) or a wireless remote control (sold separately, ) is recommended.

? FAQ

- **Focusing is not possible (indicated by an orange AF point).**
Aim the AF point over an area with good contrast, then press the shutter button halfway (). If you are too close to the subject, move away and shoot again.
- **After focusing, multiple AF points are displayed simultaneously.**
Focus has been achieved at all those points.
- **The shutter speed display is blinking.**
Since it is too dark, taking the picture may result in a blurred subject due to camera shake. Using a tripod or a Canon EL/EX series Speedlite (sold separately, ) is recommended.
- **The bottom of pictures taken with flash is unnaturally dark.**
If a hood is attached to the lens, it may obstruct light from the flash. If the subject is close, detach the hood before taking the picture with flash.

Note

- Note the following if you are not using flash.
 - Under low light, when camera shake tends to occur, hold the camera steady or use a tripod. When using a zoom lens, you can reduce the blur caused by camera shake by setting the lens to the wide-angle end.
 - When shooting portraits under low light, tell subjects to stay still until you have finished shooting. Any movement as you shoot will make the person look blurry in the picture.

A+: Fully Automatic Techniques (Scene Intelligent Auto)

[Shooting Moving Subjects](#)

[Scene Icons](#)

Shooting Moving Subjects



Pressing the shutter button halfway tracks moving subjects to keep them in focus. Keep the subject on the screen as you hold down the shutter button halfway, and at the decisive moment, press the shutter button completely.

Scene Icons



The camera detects the scene type and sets everything automatically to suit the scene. The detected scene type is indicated in the upper left of the screen. For icon details, see [Scene Icons](#).

Fv: Flexible-Priority AE

Enables the shutter speed, aperture value, and ISO speed to be set automatically or manually. Equivalent to shooting in [P], [Tv], [Av], or [M] mode without needing to switch to these modes.

* [Fv] stands for Flexible value.

* AE stands for Auto Exposure.

1. Set the shooting mode to [Fv].

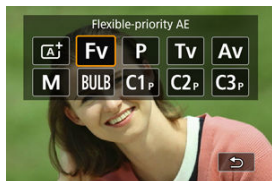

- Press the <MODE> button, then turn the <MODE> dial to select [Fv].

2. Set the shutter speed, aperture value, and ISO speed.



- Turn the <MODE> dial to select an item to set. [MODE] appears to the left of the selected item.
- Turn the <MODE> dial to set the option.
- To reset the setting to [AUTO], press the <MODE> button.

3. Set the amount of exposure compensation.



- Turn the < > dial and select the exposure level indicator. [] or [] appears to the left of the exposure level indicator.
- Turn the < > or < > dial to set the level.
- To reset the setting to $[\pm 0]$, press the < > button.

Combinations of functions in [Fv] mode

Shutter Speed	Aperture Value	ISO Speed	Exposure Compensation	Shooting Mode
[AUTO]	[AUTO]	[AUTO]	Available	Equivalent to [P]
		Manual selection		
Manual selection	[AUTO]	[AUTO]	Available	Equivalent to [Tv]
		Manual selection		
[AUTO]	Manual selection	[AUTO]	Available	Equivalent to [Av]
		Manual selection		
Manual selection	Manual selection	[AUTO]	Available	Equivalent to [M]
		Manual selection	—	

Caution

- Blinking of the values indicates a risk of underexposure or overexposure. Adjust the exposure until the value stops blinking. Slow synchro is not used under low light when you have set up [Fv] mode to resemble [P] or [Av] mode, even when [Slow synchro] in [: External Speedlite control] is set to [1/*-30sec. auto].*¹
* 1: The value of "1/*" varies depending on current settings.



Note

- Values for shutter speed, aperture value, and ISO speed that are set to **AUTO** are underlined.
- You can set shutter speed, aperture value, and ISO speed to **AUTO** and exposure compensation amount to **±0** in step 2 or 3 by holding down the <  > button.

P: Program AE

The camera automatically sets the shutter speed and aperture value to suit the subject's brightness.

* [P] stands for Program.

1. Set the shooting mode to [P].



- Press the <MODE> button, then turn the <MODE DIAL> dial to select [P].

2. Focus on the subject.



- Aim the AF point over the subject and press the shutter button halfway.
- Once the subject is in focus, an AF point is displayed (in green for One-Shot AF or blue for Servo AF).
- The shutter speed and aperture value are set automatically.

3. Check the display.



- As long as the exposure value is not blinking, standard exposure will be obtained.

4. Take the picture.

- Compose the shot and press the shutter button completely.

Caution

- If a slow shutter speed and low aperture value blink, the subject is too dark. Increase the ISO speed or use flash.
- If a fast shutter speed and high aperture value blink, the subject is too bright. Lower the ISO speed or use an ND filter (sold separately) to reduce the amount of light entering the lens.

Note

Differences between [P] and [A+] modes

- [A+] mode limits available functions and sets the AF area, metering mode, and many other functions automatically to prevent bad shots. In contrast, [P] mode only sets the shutter speed and aperture value automatically, and you can freely set the AF area, metering mode, and other functions.

Program shift

- In [P] mode, you can freely change the combination (program) of shutter speed and aperture value set automatically by the camera while maintaining the same exposure. This is called Program shift.
- With Program shift, you can press the shutter button halfway, then turn the  > dial until the desired shutter speed or aperture value is displayed.
- Program shift will be canceled automatically when the metering timer ends (exposure setting display turns off).
- Program shift cannot be used with flash.

Tv: Shutter-Priority AE

In this mode, you set the shutter speed and the camera automatically sets the aperture value to obtain the standard exposure matching the brightness of the subject. A faster shutter speed can freeze the action of a moving subject. A slower shutter speed can create a blurred effect, giving the impression of motion.

* [Tv] stands for Time value.





Blurred motion
(Slow speed: 1/30 sec.)

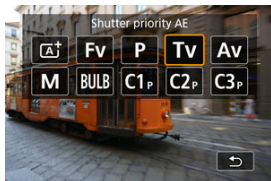

Frozen motion
(Fast speed: 1/2000 sec.)

1. Set the shooting mode to [Tv].



- Press the <MODE> button, then turn the <  > dial to select [Tv].

2. Set the desired shutter speed.



- Turn the <  > dial to set it.

3. Focus on the subject.

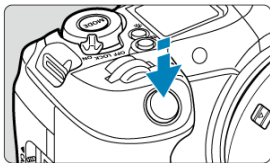

- Press the shutter button halfway.
- The aperture value is set automatically.

4. Check the display and shoot.



- As long as the aperture value is not blinking, the standard exposure will be obtained.

Caution



- If the lowest aperture value blinks, it indicates underexposure. Turn the <  > dial to set a slower shutter speed until the aperture value stops blinking or set a higher ISO speed.



- If the highest aperture value blinks, it indicates overexposure. Turn the <  > dial to set a faster shutter speed until the aperture value stops blinking, or set a lower ISO speed.



Note

- [""] in shutter speed display stands for "seconds." ([0"5] → 0.5 sec., [15"] → 15 sec., etc.)

Av: Aperture-Priority AE

[Depth-of-Field Preview](#)

In this mode, you set the desired aperture value and the camera sets the shutter speed automatically to obtain the standard exposure matching the subject brightness. A higher $f/$ number (smaller aperture hole) will make more of the foreground and background fall within acceptable focus. On the other hand, a lower $f/$ number (larger aperture hole) will make less of the foreground and background fall within acceptable focus.

* [Av] stands for Aperture value (aperture opening).



Blurred background
(With a low aperture value: $f/5.6$)

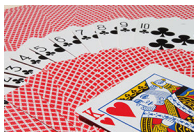

Sharp foreground and background
(With a high aperture value: $f/32$)

1. Set the shooting mode to [Av].



- Press the <MODE> button, then turn the < > dial to select [Av].

2. Set the desired aperture value.



- Turn the <  > dial to set it.

3. Focus on the subject.

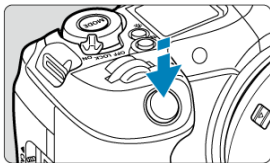



- Press the shutter button halfway.
- The shutter speed is set automatically.

4. Check the display and shoot.



- As long as the shutter speed is not blinking, the standard exposure will be obtained.

Caution

- If a slow shutter speed blinks, it indicates underexposure.
Turn the <  > dial to decrease the aperture value (open the aperture) until the shutter speed blinking stops or set a higher ISO speed.
- If a fast shutter speed blinks, it indicates overexposure.
Turn the <  > dial to increase aperture value (close the aperture) until the shutter speed blinking stops or set a lower ISO speed.

 **Note**

Aperture value display

- The higher the value, the smaller the aperture opening will be. The aperture value displayed varies depending on the lens. If no lens is attached to the camera, **[F00]** will be displayed for the aperture.

Depth-of-Field Preview

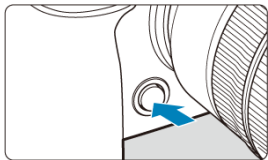

Press the depth-of-field preview button to stop down the lens to the current aperture value setting and check the area in focus (depth of field).

 **Note**

- The larger the aperture value, the wider the area in focus, from the foreground to the background.
- The depth-of-field effect is readily apparent on images as you change the aperture value and press the depth-of-field preview button.
- Exposure is locked (AE lock) as you hold down the depth-of-field preview button.

M: Manual Exposure

[Exposure Compensation with ISO Auto](#)

In this mode, you set both the shutter speed and aperture value as desired. To determine the exposure, refer to the exposure level indicator or use a commercially available exposure meter.



* [M] stands for Manual.

1. Set the shooting mode to [M].





- Press the <MODE> button, then turn the < > dial to select [M].

2. Set the ISO speed .

- Turn the < > dial to set it.
- With ISO Auto, you can set exposure compensation ().

3. Set the shutter speed and aperture value.



- To set the shutter speed, turn the < > dial, and to set the aperture value, turn the < > dial.

4. Focus on the subject.



- Press the shutter button halfway.
- Check the exposure level mark [] to see how far the current exposure level is from the standard exposure level.

(1) Standard exposure index

(2) Exposure level mark

5. Set the exposure and take the picture.



- Check the exposure level indicator and set the desired shutter speed and aperture value.

Exposure Compensation with ISO Auto









If the ISO speed is set to **[AUTO]** for manual exposure shooting, you can set exposure compensation (⊖) as follows:

- Tap the exposure level indicator
- **[📷: Expo.comp./AEB]**
- Quick Control screen
- Turn the control ring while pressing the shutter button halfway

⚠ Caution

- Exposure may not be as expected when ISO Auto is set, because the ISO speed is adjusted to ensure standard exposure for your specified shutter speed and aperture value. In this case, set the exposure compensation.
- Exposure compensation is not applied in flash photography with ISO Auto, even if you have set an exposure compensation amount.

 **Note**

- In **[M]** mode with ISO Auto, [, **evaluative metering**], and [, **AE lock meter. mode after focus**] set to the default setting () , holding down the shutter button halfway locks the ISO speed after the camera focuses with One-Shot AF.
- When ISO Auto is set, you can press the <  > button to lock the ISO speed.
- If you press the <  > button and recompose the shot, you can see the exposure level difference on the exposure level indicator compared to when the <  > button was pressed.
- Any existing exposure compensation amount is maintained if you switch to **[M]** mode with ISO Auto after using exposure compensation in **[P]**, **[Tv]**, or **[Av]** mode () .
- To coordinate exposure compensation in 1/2-stop increments with ISO speed set in 1/3-stop increments when [, **Exposure level increments**] is set to **[1/2-stop]** and used with ISO Auto, exposure compensation is further adjusted by adjusting shutter speed. However, the shutter speed displayed will not change.

BULB: Long (Bulb) Exposures

[Bulb Timer](#) ☆

In this mode, the shutter stays open as long as you hold down the shutter button completely, and closes when you let go of the shutter button. Use bulb exposures for night scenes, fireworks, astrophotography, and other subjects requiring long exposures.

1. Set the shooting mode to [BULB].

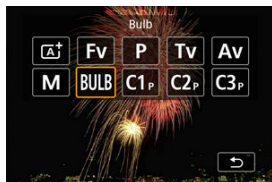

- Press the < MODE > button, then turn the <  > dial to select [BULB].

2. Set the desired aperture value.

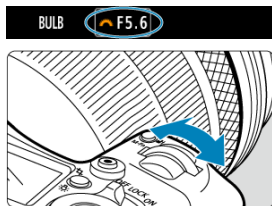

- Turn the <  > dial to set it.



3. Take the picture.

- The exposure will continue for as long as you keep the shutter button pressed completely.
- Elapsed exposure time is displayed on the LCD panel.

Caution

- Do not point the camera toward an intense light source, such as the sun or an intense artificial light source. Doing so may damage the image sensor or the camera's internal components.
- Long bulb exposures produce more noise in the image than usual.
- ISO 400 is used when the camera is set to ISO Auto.
- When shooting bulb exposures with the self-timer instead of the bulb timer, keep pressing the shutter button completely (for the self-timer time and bulb exposure time).

Note

- You can reduce the noise generated during long exposures by using [: **Long exp. noise reduction**] ().
- Using a tripod and the bulb timer is recommended for bulb exposures.
- You can also shoot bulb exposures with Remote Switch RS-80N3 (sold separately, ).
- You can also shoot bulb exposures with Wireless Remote Control BR-E1 (sold separately). When you press the remote controller's release (transmit) button, the bulb exposure will start immediately or 2 sec. later. Press the button again to stop the bulb exposure.

You can set the exposure time for bulb exposures in advance. This feature eliminates the need to keep holding down the shutter button during bulb exposures, which can reduce camera shake.

Note that the bulb timer can only be set and will only take effect in **[BULB]** (bulb exposure) mode.

1. Select **[📷: Bulb timer]** (🔗).

2. Select **[Enable]**.

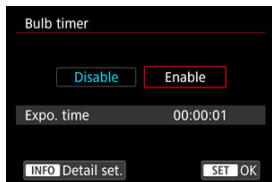

- Select **[Enable]**, then press the **<INFO>** button.

3. Set the exposure time.

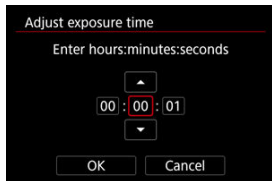

- Select an option (hours : minutes : seconds).
- Press **<SET>** to display (📷).
- Set a value, then press **<SET>**. (Returns to [📷].)

4. Select [OK].

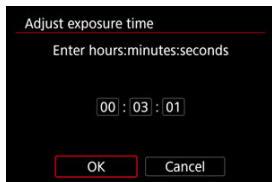

5. Take the picture.

- After you press the shutter button completely, the bulb exposure continues for your specified time.
- [**TIMER**] and the exposure time are displayed on the LCD panel during bulb timer shooting.
- To clear the timer setting, select [**Disable**] in step 2.

! Caution

- Bulb exposure stops if you press the shutter button completely and release it during the timer.
- Bulb exposure continues even after your specified exposure time if you keep pressing the shutter button completely (which overrides automatic stopping when your specified exposure time elapses).
- The bulb timer is cleared (and reverts to [**Disable**]) when you switch shooting modes.

Shooting and Recording

This chapter describes shooting and recording and introduces menu settings on the shooting [📷] tab.

- [Still Photo Shooting](#)
- [Movie Recording](#)

Still Photo Shooting



To prepare for still photo shooting, set the still photo shooting/movie recording switch to <  >, then press the < **MODE** > button and choose a shooting mode.

☆ to the right of titles indicates functions only available in [**Fv**], [**P**], [**Tv**], [**Av**], [**M**], or [**BULB**] mode.

- [Tab Menus: Still Photo Shooting](#)
- [Image Quality](#)
- [Still Photo Cropping/Aspect Ratio](#)
- [Auto Exposure Bracketing \(AEB\)](#) ☆
- [ISO Speed Settings for Still Photos](#) ☆
- [Anti-Flicker Shooting](#) ☆
- [High-Frequency Anti-Flicker Shooting](#) ☆
- [Shooting with Speedlites](#) ☆
- [Flash Function Settings](#) ☆
- [Picture Style Selection](#) ☆
- [Picture Style Customization](#) ☆
- [Picture Style Registration](#) ☆
- [HDR Shooting \(PQ\)](#) ☆
- [Color Space](#) ☆
- [Clarity](#) ☆
- [Auto Lighting Optimizer](#) ☆
- [Highlight Tone Priority](#) ☆
- [White Balance](#) ☆

- [Custom White Balance](#)☆
- [White Balance Correction](#)☆
- [Lens Aberration Correction](#)☆
- [Long Exposure Noise Reduction](#)☆
- [High ISO Speed Noise Reduction](#)☆
- [Dust Delete Data Acquisition](#)☆
- [Multiple Exposures](#)☆
- [Focus Bracketing](#)☆
- [Pre-Continuous Shooting](#)☆
- [Interval Timer Shooting](#)
- [Silent Shutter Function](#)☆
- [Shutter Mode](#)☆
- [Enabling Shutter Release Without a Card](#)
- [Image Stabilizer \(IS Mode\)](#)
- [Customizing Quick Controls](#)☆
- [Shooting with the Touch Shutter](#)
- [Image Review](#)
- [High-Speed Display](#)☆
- [Metering Timer](#)☆
- [HDR/C. Log View Assist](#)☆
- [Display Simulation](#)☆
- [Optical Viewfinder Simulation](#)☆
- [Blackout-Free Display](#)☆
- [Shooting Information Display](#)
- [Reverse Display](#)
- [Display Frame Rate](#)
- [Viewfinder Display Format](#)
- [Auto Power Off Temperature](#)
- [Metering Mode Selection](#)☆
- [AE for Priority Subjects During AF](#)☆

- [Manual Exposure Compensation](#) ☆
- [Exposure Lock \(AE Lock\)](#) ☆
- [General Still Photo Shooting](#)

Tab Menus: Still Photo Shooting

● Image quality/size

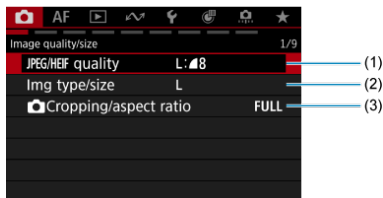

- (1) [JPEG/HEIF quality](#)
- (2) [Img type/size](#)
- (3) [Cropping/aspect ratio](#)

● Exposure

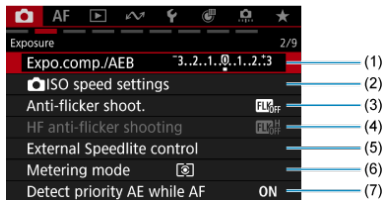

- (1) [Expo.comp./AEB](#) ☆
- (2) [ISO speed settings](#) ☆
- (3) [Anti-flicker shoot.](#) ☆
- (4) [HF anti-flicker shooting](#) ☆
- (5) [External Speedlite control](#) ☆
- (6) [Metering mode](#) ☆
- (7) [Detect priority AE while AF](#) ☆

● Color/tone/Dynamic range

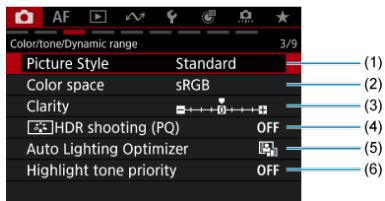

(1) Picture Style

- [Picture Style Selection](#) ☆
- [Picture Style Customization](#) ☆
- [Picture Style Registration](#) ☆

(2) Color space ☆

(3) Clarity ☆

(4) HDR shooting (PQ) ☆

(5) Auto Lighting Optimizer ☆

(6) Highlight tone priority ☆

● White balance/Quality correction

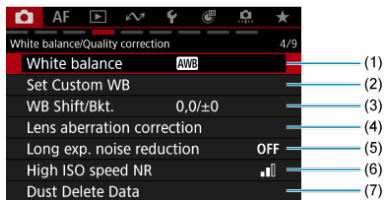

(1) White balance ☆

(2) Set Custom WB ☆

(3) WB Shift/Bkt. ☆

(4) Lens aberration correction ☆

(5) Long exp. noise reduction ☆

(6) High ISO speed NR ☆

(7) Dust Delete Data ☆

● Various shooting

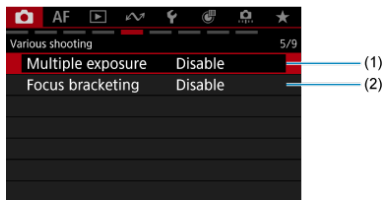

(1) [Multiple exposure](#) ☆

(2) [Focus bracketing](#) ☆

● Shutter control

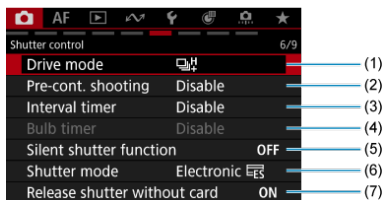

(1) [Drive mode](#)

(2) [Pre-cont. shooting](#) ☆

(3) [Interval timer](#)

(4) [Bulb timer](#) ☆

(5) [Silent shutter function](#) ☆

(6) [Shutter mode](#) ☆

(7) [Release shutter without card](#)

● Assist shooting

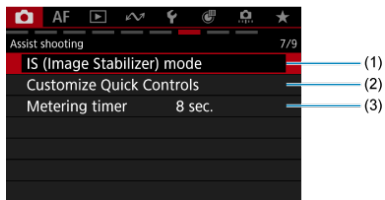

- (1) [IS \(Image Stabilizer\) mode](#)
- (2) [Customize Quick Controls](#) ☆
- (3) [Metering timer](#) ☆

● Assist shooting

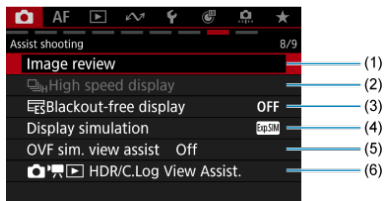

- (1) [Image review](#)
- (2) [High speed display](#) ☆
- (3) [Blackout-free display](#) ☆
- (4) [Display simulation](#) ☆
- (5) [OVF sim. view assist](#) ☆
- (6) [HDR/C.Log View Assist.](#) ☆

⚠ Caution

- **[📷: IS (Image Stabilizer) mode]** is not displayed when an IS-equipped lens is attached.

● Assist shooting

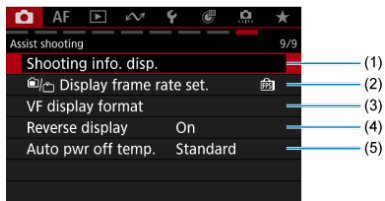

- (1) [Shooting info. disp.](#)
- (2) [Display frame rate set.](#)
- (3) [VF display format](#)
- (4) [Reverse display](#)
- (5) [Auto pwr off temp.](#)

Image Quality

- [✔ Image Size Selection](#)
- [✔ RAW Images](#)
- [✔ Guide to Image Quality Settings](#)
- [✔ Maximum Burst for Continuous Shooting](#)
- [✔ JPEG/HEIF Quality](#)



Note



- "Image quality" in this guide refers to both image size and JPEG/HEIF quality ([🔗](#)).

Image Size Selection

You can specify **L**, **M**, **S1**, or **S2** for JPEG/HEIF images and **RAW** or **CRAW** for RAW images.

Note



- HEIF is available when [:  **HDR shooting (PQ)**] is set to [**HDR PQ**]. You can convert these images to JPEG images after shooting ([🔗](#)).

1. Select [: **Img type/size**] ([🔗](#)).
 - The screen displayed varies depending on [ **Rec options**] settings in [: **Record func+card/folder sel.**].

2. Set the image size.

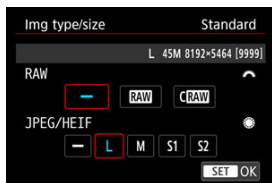



Standard/Auto switch card/Record to multiple

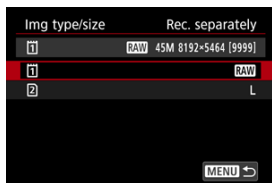

- For RAW images, turn the  dial to select the size, and for JPEG/HEIF images, turn the  dial.
- Press  to set it.

Record separately





- When  **Rec options**] in [: **Record func+card/folder sel.**] is set to **[Rec. separately]**, turn the  dial to select **[1]** or **[2]**, then press . Note that recording separately to **RAW** and **CRAW** is not available for RAW images.



- Select an image size on the screen displayed, then press .



 **Note**

- **L** is set if you set both RAW and JPEG/HEIF to **[—]**.
- Two versions of each shot are recorded at your specified image quality when you have selected both RAW and JPEG/HEIF. Both images have the same file number but each has a different file extension, with .JPG for JPEG, .HIF for HEIF and .CR3 for RAW.
- To record in different image quality to each card (as a RAW and JPEG image, for example), set  **Rec options**] in : **Record func+card/folder sel.**] to **[Rec. separately]**.
- Meanings of image size icons are as follows: **RAW**: RAW, **CRRAW**: Compact RAW, JPEG: JPEG, HEIF: HEIF, **L**: Large, **M**: Medium, **S1**: Small 1, **S2**: Small 2.

RAW Images

RAW images are raw data from the image sensor in a digital form.

Compared to **RAW** image files, **CRRAW** offers smaller file sizes.

To process RAW images and save them as JPEG or HEIF images, you can use : **RAW image processing**  or Digital Photo Professional (EOS software).

For details on Digital Photo Professional, refer to the Digital Photo Professional instruction manual.

Note

- To view RAW images on a computer, consider using Digital Photo Professional (DPP).
- RAW images from this camera cannot be used with older versions of DPP. Download the latest version of DPP from the Canon website and install it, which will overwrite the previous version .
- Commercially available software may not be able to display RAW images captured by this camera. For compatibility information, contact the software manufacturer.

Guide to Image Quality Settings

See [Still photo file size / Number of possible shots / Maximum burst for continuous shooting](#) for details on file size, number of shots available, maximum burst, and other estimated values.

Maximum Burst for Continuous Shooting



The approximate maximum burst is displayed at the upper left of the shooting screen and lower right of the viewfinder.

Note

- If the maximum burst is displayed as "99", it indicates that you can shoot 99 or more shots continuously. Fewer shots are available for a value of 98 or lower, and when **[BUSY]** is displayed on the screen, internal memory is full and shooting will stop temporarily. If you stop continuous shooting, the maximum burst will increase. After all captured images have been written to a card, you can once again shoot at the maximum burst listed in [Still photo file size / Number of possible shots / Maximum burst for continuous shooting](#).

1. Select [📷: JPEG/HEIF quality] (🔗).
2. Select the desired image size.



- Select the image size, then press < SET >.

3. Set the desired quality (compression).



- Select the number, then press < SET >.
- Higher numbers offer higher quality (lower compression).
- Quality of 6–10 is indicated by < ▀ >, and 1–5, by < ▣ >.

Note

- The higher the quality, the fewer shots will be available. In contrast, the lower the quality, the more shots will be available.

Still Photo Cropping/Aspect Ratio

When using an RF or EF lens, you can change the aspect ratio before shooting. You can use **[1.6x (crop)]** to shoot as if using a telephoto lens, because this option magnifies the center of the image (an area equivalent to APS-C size). With RF-S/EF-S lenses, **[1.6x (crop)]** is set automatically.

1. Select [📷: 📷Cropping/aspect ratio] (🔗).
2. Select an option.

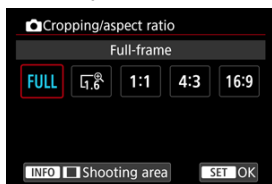





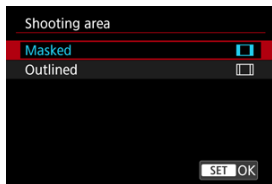









- To proceed without changing shooting area display, press < (SET) > and go to step 4.

3. Select how the shooting area is displayed.



- On the screen in step 2, press the < INFO > button.
- Select the type of display, then press < SET >.

 **Caution**

-  /  /  /  image quality options are not available when [1.6x (crop)] is set, or with RF-S/EF-S lenses.
- Shooting with [1.6x (crop)] and image quality set to  /  /  /  /  produces  /  /  /  images, respectively.
- [1.6x (crop)] is used automatically with RF-S/EF-S lenses.

4. Take the picture.

Setting examples

When FULL is set



When $\square_{1.6}$ is set or an RF-S or EF-S lens is used



When 1:1/ \square is set





When 4:3/ \square is set



- When [1.6x (crop)] is set or an RF-S/EF-S lens is used, an image magnified approx. 1.6× is displayed.
- When [1:1 (aspect ratio)], [4:3 (aspect ratio)], or [16:9 (aspect ratio)] is set, the image within the black masked or outlined area is captured.

Caution

- **Areas outside the cropped area are not recorded in RAW shooting when [1.6x (crop)] is set, or with RF-S/EF-S lenses.**
- [Shooting area] has no effect on display when [1.6x (crop)] is set, or with RF-S/EF-S lenses.
- [: Add cropping information] is only available when [Full-frame] is set.
- When external flash units are used, flash auto zoom (automatic adjustment of flash coverage) based on the [:  Cropping/aspect ratio] setting is not performed.

Note

- For details on pixel counts when cropping or an aspect ratio is set, see [Recording pixel count](#) for still photo recording.
- Nearly 100% field of view coverage is maintained vertically and horizontally when cropping or an aspect ratio is set.
- Aspect ratio information is added to RAW images when an aspect ratio is set, which are captured at full size. When the RAW images are played back, the image area used for shooting is indicated by lines. Note that only the shooting image area is shown in [Slide Show](#).

In exposure bracketing, three consecutive images are captured at different exposures by automatically adjusting the shutter speed, aperture value, and ISO speed.

* AEB stands for Auto Exposure Bracketing.

1. Select [📷: Expo.comp./AEB] (🔗).

2. Set the AEB range.

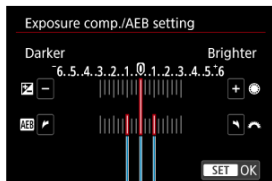

(1)

- Turn the <📷> dial to set the AEB range (1). By turning the <🔍> dial, you can set the exposure compensation amount.
- Press <SET> to set it.
- When you close the menu, the AEB range will be displayed on the screen.

3. Take the picture.

Standard exposure

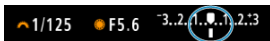

Decreased exposure

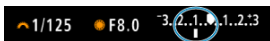

Increased exposure

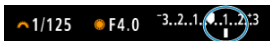

- Three bracketed shots are taken, according to the specified drive mode, in this sequence: Standard exposure, decreased exposure, and increased exposure.
- AEB will not be automatically canceled. To cancel AEB, follow step 2 to turn off the AEB range display.

⚠ Caution

- Exposure compensation in AEB may be less effective with **[Auto Lighting Optimizer]** (🔍) set to an option other than **[Disable]**.

📄 Note

- **[*]** blinks in the lower left of the screen during AEB.
- If the drive mode is set to **[□]**, press the shutter button three times for each shot. In **[📷]**, **[📷H]**, or **[📷]** mode, holding down the shutter button completely captures three images, one after another, before the camera automatically stops shooting. When **[📷10]** or **[📷C]** is set, three consecutive shots are captured after a delay of 10 sec. When **[📷2]** is set, three consecutive shots are captured after a delay of 2 sec.
- You can set AEB in combination with exposure compensation.
- AEB is not available in flash photography or bulb exposures, or focus bracketing.
- AEB will be canceled automatically if you do any of the following: Setting the power switch to **<OFF>** or when the flash is fully charged.

[ISO Speed Range When Set Manually](#)

[ISO Speed Range Used with ISO Auto](#)

[Minimum Shutter Speed for ISO Auto](#)

Set the ISO speed (image sensor's sensitivity to light) to suit the ambient light level. In [A+] mode, ISO speed is set automatically.

For details on ISO speed in movie recording, see [ISO speed \(recommended exposure index\) in movie recording](#).

Setting with a dial

1. Set the ISO speed.



- With an image displayed on the screen, set by turning the <  > dial.
- Select [AUTO] to set the ISO speed automatically.
- When [AUTO] is selected, pressing the shutter button halfway will display the ISO speed actually set.
- For details on the ISO Auto range, see [ISO speed \(recommended exposure index\) in still photo shooting](#).

Setting ISO speed from a screen of options

1. Access the screen of ISO speed options.



- Tap the ISO speed in the lower right of the screen.

2. Select an option.



- Turn the <  > dial or select a registered setting value.
- You can register frequently used ISO speed setting values by specifying an option other than [AUTO] and selecting [Register].

Note

- To specify [AUTO] when setting [ISO speed] in [:  ISO speed settings], press the < INFO > button.

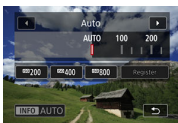

ISO speed guide

- Low ISO speeds reduce image noise but may increase the risk of camera/subject shake or reduce the area in focus (shallower depth of field), in some shooting conditions.
- High ISO speeds enable low-light shooting, a larger area in focus (deeper depth of field), and longer flash range but may increase image noise.



Note

- ISO speed can also be set with the $\langle \text{ISO} \rangle$ button by pressing the $\langle \text{M-Fn} \rangle$ button to select the ISO speed item while an image is displayed.
- Can also be set on the **[ISO speed]** screen in **[CAMERA: ISO speed settings]**.
- To expand the available ISO speed range from L (equivalent to ISO 50) to H (equivalent to ISO 102400), adjust **[ISO speed range]** in **[CAMERA: ISO speed settings]** (✓).



Caution

- Image noise (dots of light or banding) and irregular colors may increase and apparent resolution may decrease at H (equivalent to ISO 102400), because this is an expanded ISO speed.
- Because L (equivalent to ISO 50) is an expanded ISO speed setting, the dynamic range will be somewhat narrower compared to the standard setting.
- When shooting with a high ISO speed, high temperature, long exposure, or multiple exposure, image noise (graininess, dots of light, banding, etc.), irregular colors, or color shift may become noticeable.
- When shooting in conditions that produce an extreme amount of noise, such as a combination of high ISO speed, high temperature, and long exposure, images may not be recorded properly.
- If you use a high ISO speed and flash to shoot a close subject, overexposure may result.

ISO Speed Range When Set Manually

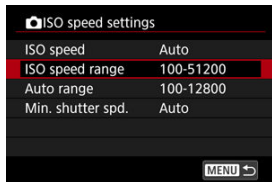

You can set the manual ISO speed setting range (minimum and maximum limits).

1. Select [:  ISO speed settings] ().
2. Select [ISO speed range].

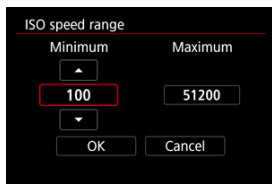

3. Set [Minimum].



- Select the [Minimum] box, then press <  >.
- Select the ISO speed, then press <  >.

4. Set [Maximum].

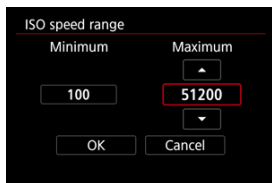

- Select the [Maximum] box, then press < (SET) >.
- Select the ISO speed, then press < (SET) >.

5. Select [OK].

ISO Speed Range Used with ISO Auto

You can set the automatic ISO speed range for ISO Auto.

1. Select [Auto range].

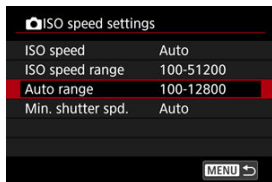

2. Set [Minimum].



- Select the [Minimum] box, then press < (SET) >.
- Select the ISO speed, then press < (SET) >.

3. Set [Maximum].

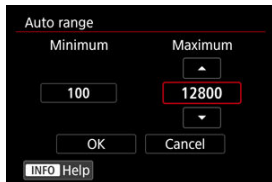

- Select the [Maximum] box, then press < (SET) >.
- Select the ISO speed, then press < (SET) >.

4. Select [OK].



Note

- The **[Minimum]** and **[Maximum]** settings will also function as the minimum and maximum speeds for ISO speed safety shift (Ⓢ).

Minimum Shutter Speed for ISO Auto

To prevent shutter speeds from being set too low automatically, you can set the minimum shutter speed for ISO Auto.

This is effective in **[P]** or **[Av]** mode when shooting subjects in motion with a wide-angle lens, or when using a telephoto lens. It can also reduce camera shake and blurred subjects.

1. Select **[Min. shutter spd.]**.

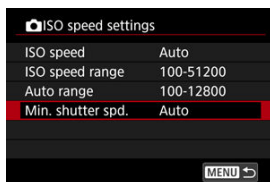

2. Set the desired minimum shutter speed.



Auto

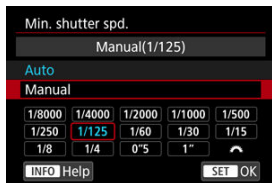

- If you select **[Auto]**, turn the  dial to set the difference relative to standard speed (toward **Slower** or **Faster**), then press .

Manual



- If you select **[Manual]**, turn the  dial to select the shutter speed, then press .

Caution

- If a correct exposure cannot be obtained with the maximum ISO speed limit set with **[Auto range]**, a shutter speed slower than the **[Min. shutter spd.]** will be set to obtain the standard exposure.
- This function will not be applied to flash photography.

Note

- When **[Auto (Standard)]** is set, the minimum shutter speed will be the reciprocal of the lens focal length. A single step from **[Slower]** to **[Faster]** is equivalent to a single stop of the shutter speed.

Uneven exposure and color may appear in continuous shooting at fast shutter speeds under flickering light sources such as fluorescent lights, due to uneven vertical exposure. Anti-flicker shooting enables you to take pictures when exposure and colors are less affected by flickering.

1. Select [: Anti-flicker shoot.] ().
2. Select [Enable].

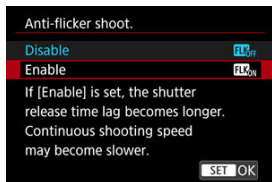

3. Take the picture.

Caution

- When **[Enable]** is set and you shoot under a flickering light source, the shutter-release time lag may become longer.
- Flicker at a frequency other than 50 Hz or 60 Hz cannot be detected. Also, if the flickering frequency of the light source changes during continuous shooting, effects of the flicker cannot be reduced.
- In **[Fv]**, **[P]**, or **[Av]** mode, color tone of captured images may vary if the shutter speed changes during continuous shooting or if you take multiple shots of the same scene at different shutter speeds. To avoid inconsistent color tone, shoot in **[Fv]**, **[Tv]**, or **[M]** mode at a fixed shutter speed.
- Color tone of captured images may vary between **[Enable]** and **[Disable]**.
- Shutter speed, aperture value, and ISO speed may change when you start shooting with AE lock.
- If the subject is against a dark background or if there is a bright light in the image, flicker may not be properly detected.
- Flicker reduction may not be possible under special lighting.
- Depending on the light source, flicker may not be detected properly.
- Depending on the light sources or shooting conditions, the expected result may not be obtained even if you use this function.
- Exposure in flash photography may vary.

Note

- Taking test shots in advance is recommended.
- Detect flicker manually if the screen flickers (as when the light source changes) by pressing the **<[Q]>** button, selecting **[Anti-flicker shoot.]**, then pressing the **<[INFO]>** button.
- Flicker is not reduced in **[A+]** mode.

☑ [Recommended Tv Setting](#)

☑ [Manual Setting](#)

Images may be affected by banding if you shoot under light sources that flicker at high frequencies. High-frequency anti-flicker shooting enables you to take pictures at suitable shutter speeds for high-frequency flickering, which minimizes the effect of this flickering on images.

! Caution

- Exposure in still photo shooting may vary.
- Before high-frequency anti-flicker shooting, consider setting [: **Same expo. for new aperture**] to [ISO speed].

1. Select a shooting mode ().

- Press the <MODE> button to select [Tv] or [M].

2. Select [: HF anti-flicker shooting] (,).

3. Select [HF anti-flicker shooting].

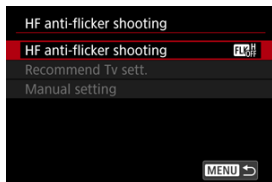

4. Select [Enable].

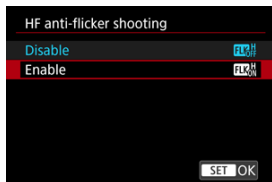

5. Select an item.

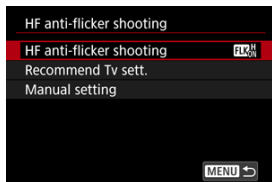

Recommended Tv Setting

The camera detects 50.0–8193.7 Hz light sources and displays a suitable shutter speed for shooting under light sources that flicker at high frequencies. You can then switch to the indicated shutter speed.

1. Set the desired shutter speed.

- Set the shutter speed you would prefer to shoot at. For light sources that flicker at high frequencies, the camera will determine a suitable shutter speed near this value.

2. Select [Recommend Tv sett.].

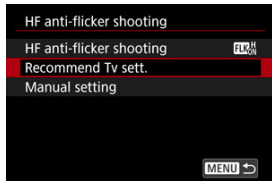

3. Select [OK].

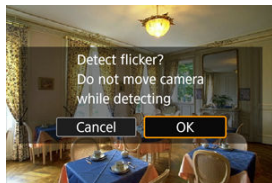

- It may improve HF flicker detection accuracy to magnify, as much as possible, any areas affected by banding.

4. Switch to the indicated shutter speed.

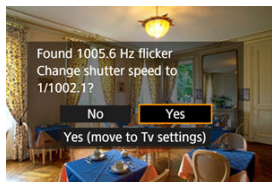

- Select [**Yes**] to switch to the indicated shutter speed.
- Selecting [**Yes (move to Tv settings)**] will display the [**Manual setting**] screen. Go to step 2 in [Manual Setting](#).

5. Take the picture.

Caution

- Shutter speeds displayed will be in a range of 1/50.0–1/8192.0 sec.
- Do the following if [**No flicker detected**] is displayed, or if switching shutter speeds does not eliminate banding.
 - Set the recommended Tv setting again.
 - Change how the camera is facing, as by rotating it about 90°, then set the recommended Tv setting.
 - Try the manual setting option
- HF flicker detection may be less accurate under these conditions.
 - Scenes with repetitive patterns (with a lattice or stripes, for example)
 - Subjects in constant motion
 - Extremely bright or dark scenes
 - Scenes with multiple light sources
 - Scenes with small flashing light sources
 - Light sources flickering at lower frequencies

Note

- Display of affected movies is not updated if a recommended Tv setting is applied for high-frequency flickering during HDMI output of 8K/4K movies.

Manual Setting

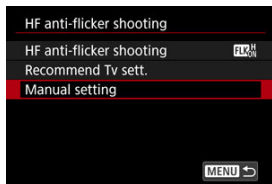

Check on the screen for image areas affected by light sources that flicker at high frequencies, then find a suitable shutter speed.

1. Select [Manual setting].





2. Adjust the shutter speed.



- Do the following if banding is not eliminated at the shutter speed set by the recommended Tv setting.
 - Turn the  dial. With the  dial, you can increase the shutter speed set by the recommended Tv setting ($\times 2$, $\times 3$, $\times 4$, and so on) or decrease it ($1/2\times$, $1/3\times$, $1/4\times$, and so on).
 - Turn the  dial to fine-tune the setting.
- If this does not eliminate banding, change how the camera is facing, as by rotating it about 90° , then set the recommended Tv setting.

3. Shoot.

 **Caution**

- Shutter speeds you can set manually are in a range of 1/50.0–1/8192.0 sec.
- Maximum sync speed in flash photography is limited to 1/181.0 sec. in shutter modes other than **[Electronic **.
- In **[Electronic ** shutter mode, maximum sync speed in flash photography is limited to 1/128.0 sec. The following conditions limit maximum flash sync speed to 1/181.0 sec.
 - With RF-S or EF-S lenses attached
 - When set to **[1.6x (crop)]** 
- Dark lenses may prevent correct display simulation.
- Image display on the screen or in the viewfinder may differ from actual shooting results. Take some test shots in advance.

- [EL/EX Series Speedlites for EOS Cameras](#)
- [Canon Speedlites Other Than the EL/EX Series](#)
- [Non-Canon Flash Units](#)
- [Quick Flash Group Control](#)

EL/EX Series Speedlites for EOS Cameras

Features of EL/EX series Speedlites (sold separately) can be used in flash photography with the camera.

For instructions, refer to the EL/EX series Speedlite's Instruction Manual.

Sync speed

Flash sync speeds vary as follows depending on the combination of camera settings.

Camera Setting		Flash Sync Speed
Shutter mode	Cropping/aspect ratio	
Mechanical	FULL	1/200 sec.
	1.6*	1/250 sec.
Elec. 1st-curtain	FULL	1/125 sec.
	1.6*	1/200 sec.
Electronic	FULL	1/160 sec.
	1.6*	1/250 sec.

* Equivalent to APS-C size

Note

- For a faster flash sync speed in [Elec. 1st-curtain] or [Electronic] mode, set [Sync speed priority] to [Enable] ().

Flash exposure compensation

You can adjust flash output (flash exposure compensation). With an image displayed on the screen, press the < **M-Fn** > button and use a dial to set the amount of flash exposure compensation (☑). You can set the flash exposure compensation up to ± 3 stops in 1/3-stop increments.

FE Lock

This enables you to obtain appropriate flash exposure for a specific part of the subject. Aim the viewfinder center over the subject, press the camera's < ***** > button, then compose the shot and take the picture.

⚠ Caution

- Some Speedlites cannot be attached directly to this camera. For details, see [Multi-Function Shoe](#).
- Setting [**📷: Auto Lighting Optimizer**] (☑) to an option other than [**Disable**] may still cause images to look bright even if you set lower flash exposure compensation for darker images.
- Using high-speed sync may cause banding in images. To reduce the banding, it may help to do the following.
 - Move the Speedlite farther from the camera.
 - Lower the shutter speed.
 - Set [**📷: Shutter mode**] to [**Mechanical**].

📷 Note

- The Speedlite will fire an intermittent AF-assist beam as needed, if autofocus is difficult under low light.
- You can also set flash exposure compensation on the Quick Control screen (☑) or in the [**Flash function settings**] setting of [**📷: External Speedlite control**] (☑).
- The camera can turn on certain Speedlites automatically when the camera is turned on. For details, refer to the instruction manual of Speedlites that support this feature.



Canon Speedlites Other Than the EL/EX Series

- With an EZ/E/EG/ML/TL series Speedlite set to A-TTL or TTL autoflash mode, the flash can be fired at full output only.
Set the camera's shooting mode to **[M]** or **[Av]** and adjust the aperture value before shooting.
- When using a Speedlite that has manual flash mode, shoot in the manual flash mode.

Non-Canon Flash Units

Sync speed

Sync speed for non-Canon compact flash units varies by shutter mode. Before shooting, confirm that flash sync is performed correctly.

 Shutter mode] Setting	Sync Speed
Mechanical	1/200 sec. or slower
Elec. 1st-curtain	1/250 sec. or slower
Electronic 	1/160 sec. or slower

With large studio flash units, the flash duration is longer than that of a compact flash unit and varies depending on the model. Before shooting, confirm that flash sync is performed correctly by taking some test shots at a sync speed of approx. 1/60 sec. to 1/30 sec.

Sync terminal

- You can use flash units with a sync cord via the sync terminal (). The terminal has locking threads to prevent accidental cord detachment.
- The sync terminal has no polarity. Sync cords can be connected regardless of polarity.

Caution

- Using the camera with a dedicated flash unit or flash accessory for cameras of other manufacturers poses a risk of malfunction and even damage.
- Do not connect flash units with an output voltage of 250 V or more to the camera's sync terminal.
- Do not attach a high-voltage flash unit to the camera's hot shoe. It may not fire.

Note

- You can use one flash unit attached to the camera's hot shoe and another connected to the sync terminal at the same time.

Quick Flash Group Control



As you view the shooting screen in wireless multi-flash photography, you can configure the settings for each flash group by pressing the button assigned to **[Quick flash group control]** in **[Customize buttons for shooting]**. This example is based on assigning the **<M-Fn>** button **()**.

1. Set the flash firing mode to **<Gr>** (individual group control) to prepare for wireless multi-flash photography.

- For details, refer to the instruction manuals of flash units supporting wireless multi-flash photography.

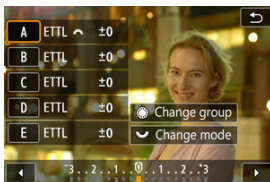
2. During standby, press the **<M-Fn>** button.



- Settings (flash mode and flash exposure compensation) for each flash group are displayed.
- Turn the **<>** dial to select a flash group (A–E) to configure.
- Turn the **<>** dial to set the flash mode.
- Turn the **<>** dial to adjust flash output or flash exposure compensation.

Note

- The **[Quick flash group control]** setting screen can be displayed in **[Fv]**, **[P]**, **[Tv]**, **[Av]**, **[M]**, or **[BULB]** mode.
- When Speedlites are set to a flash mode other than **<Gr>** (individual group control), pressing the **<M-Fn>** button displays the **[Flash function settings]** screen.

- [Flash Firing](#)
- [E-TTL Balance](#)
- [E-TTL II Flash Metering](#)
- [Continuous Flash Control](#)
- [Sync Speed Priority](#)
- [Slow Synchro](#)
- [Flash Function Settings](#)
- [Flash Custom Function Settings](#)
- [Clearing Flash Function Settings/Clearing All Speedlite Custom Functions](#)

Functions of EL/EX Series Speedlites compatible with flash function settings can be set via a camera menu screen. Attach the Speedlite to the camera and turn on the Speedlite before setting the flash functions.

For details on the Speedlite's functions, refer to the Speedlite's Instruction Manual.

1. Select [: External Speedlite control] ().

2. Select an option.

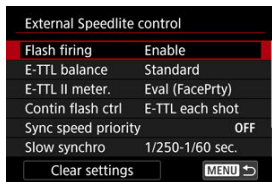

Flash Firing

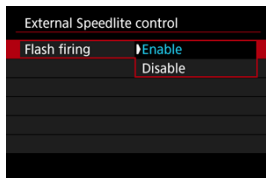

To enable flash photography, set to **[Enable]**. To enable only the AF-assist beam of the Speedlite, set to **[Disable]**.

E-TTL Balance

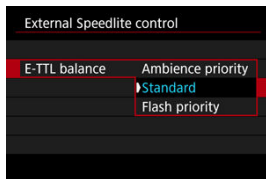

You can set your preferred appearance (balance) for flash shots. This setting enables you to adjust the ratio of ambient light to Speedlite light output.

- Set the balance to **[Ambience priority]** to lower the proportion of flash output and uses ambient light to produce lifelike shots with a natural mood. Especially useful when shooting dark scenes (indoors, for example). After switching to **[P]** or **[Av]** mode, consider setting **[Slow synchro]** in **[📷: External Speedlite control]** to **[1/*-30sec. auto]*1** and using slow-sync shooting.
- Set the balance to **[Flash priority]** to make the flash the main source of light. Useful for reducing shadows on subjects and in the background from ambient light.

* 1: The value of "1/*" varies depending on current settings.

! Caution

- For some scenes, **[Ambience priority]** may yield the same results as **[Standard]**.

E-TTL II Flash Metering

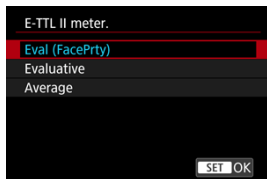

- Set to [**Eval (FacePrty)**] for flash metering suitable for shots of people.
- Set to [**Evaluative**] for flash metering that emphasizes firing in continuous shooting.
- If [**Average**] is set, the flash exposure will be averaged for the entire metered scene.



Note

- Depending on the scene, flash exposure compensation may be necessary.



Caution

- Even when [**Eval (FacePrty)**] is set, some subjects and shooting conditions may prevent you from obtaining the expected result.

Continuous Flash Control

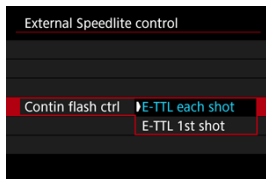

- Set to **[E-TTL each shot]** to perform flash metering for each shot.
- Set to **[E-TTL 1st shot]** to perform flash metering for only the first shot before continuous shooting. The flash output level for the first shot is applied to all subsequent shots. Useful when prioritizing continuous shooting speed without recomposing shots.

⚠ Caution

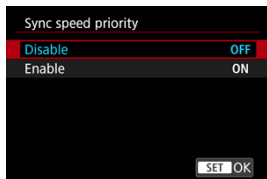

- Any subject movement in continuous shooting may cause exposure problems.
- **[E-TTL 1st shot]** is set when **[Shutter mode]** is set to **[Elec. 1st-curtain]** or **[Mechanical]** in **[Drive mode]**.

Sync Speed Priority



You can use a faster than normal sync speed in flash photography.

- Available when **[Flash mode]** is set to **[E-TTL II flash metering]**.
- Flash sync speeds vary as follows when this feature is set to **[Enable]**, depending on the combination of other camera settings.

Camera Setting		Flash Sync Speed (Fastest)
Shutter mode	 Cropping/aspect ratio	
Elec. 1st-curtain	FULL	1/320 sec.
	$\frac{1}{1.6}^*$	1/400 sec.
Electronic 	FULL	1/200 sec.
	$\frac{1}{1.6}^*$	1/320 sec.

* Equivalent to APS-C size

Note

- Also applies with Speedlite 580EX II or later when **[Flash mode]** is set to **[Manual flash]**.
- Flash units may not fire at your specified flash output level if the fastest flash sync speed is used with **[Flash mode]** set to **[Manual flash]**.
- Has no effect in **[Mechanical]** shutter mode.
- The following Speedlites support **[Sync speed priority]**.
 - Speedlite 430EX III / 470EX-AI / 600 EX II-RT / EL-100 / EL-1 / EL-5 / EL-10
 - Macro Ring Lite MR14-EX II / Macro Twin Lite MT-26EX-RT
- Underexposure may occur in some shooting conditions when **[Sync speed priority]** is set to **[Enable]**.
- Suitable exposure may not be obtained with **[Sync speed priority]** set to **[Enable]** if receiver Speedlites in radio transmission wireless shooting are set to a positive exposure compensation value.

Slow Synchro

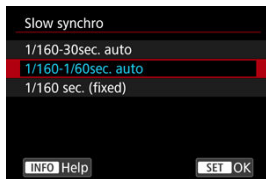

You can set the flash-sync speed for flash photography in **[P]** or **[Av]** mode. Note that the maximum flash sync speed varies depending on the combination of settings for **[C]**: **Shutter mode**] and **[C]**: **Cropping/aspect ratio**].

- **1*-30sec. auto**

The shutter speed is set automatically in the following range to suit the brightness. High-speed sync is also possible.

Shutter mode	Cropping/aspect ratio	Shutter Speed
Mechanical	FULL	1/200–30 sec.
	$\frac{1}{1.6}^*$	1/250–30 sec.
Elec. 1st-curtain	FULL	1/250–30 sec.
	$\frac{1}{1.6}^*$	1/320–30 sec.
Electronic $\overline{\text{EES}}$	FULL	1/160–30 sec.
	$\frac{1}{1.6}^*$	1/250–30 sec.





* Equivalent to APS-C size

- **1*-1/60sec. auto**

Prevents a slow shutter speed from being set automatically in low-light conditions. Effective for preventing subject blur and camera shake. Light from the flash provides standard exposure for subjects, but note that backgrounds may be dark.

- **1/* sec. (fixed)**

Shutter speed is fixed as follows, which is more effective in preventing subject blur and camera shake than with [1/*-1/60sec. auto]. However, in low light, the subject's background will come out darker than with [1/*-1/60sec. auto].

Shutter mode	 Cropping/aspect ratio	Shutter Speed
Mechanical	FULL	1/200 sec.
	 *	1/250 sec.
Elec. 1st-curtain	FULL	1/250 sec.
	 *	1/320 sec.
Electronic 	FULL	1/160 sec.
	 *	1/250 sec.

* Equivalent to APS-C size

 **Caution**

- High-speed sync is not available in [P] or [Av] mode when set to [1/* sec. (fixed)].

Flash Function Settings

The information displayed on the screen, position of display, and available options vary depending on the Speedlite model, its Custom Function settings, the flash mode, and other factors. For details on the Speedlite's functions, refer to the Speedlite's Instruction Manual.

Sample display

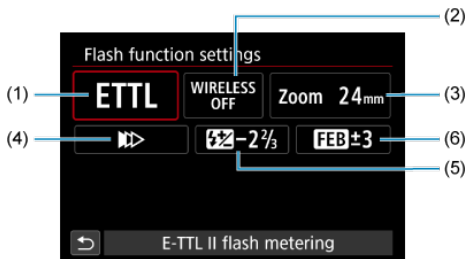

- (1) Flash mode
- (2) Wireless functions / Firing ratio control (RATIO)
- (3) Flash zoom (flash coverage)
- (4) Shutter synchronization
- (5) Flash exposure compensation
- (6) Flash exposure bracketing

Caution

- Functions are limited when using EX series Speedlites that are not compatible with flash function settings.

Flash mode

You can select the flash mode to suit your desired flash photography.

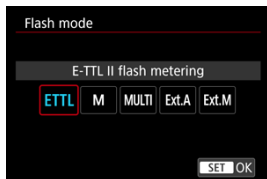

- **[E-TTL II flash metering]** is the standard mode of EL/EX series Speedlites for automatic flash photography.
- **[Manual flash]** is for setting the Speedlite's **[Flash output level]** yourself.
- Regarding other flash modes, refer to the Instruction Manual of a Speedlite compatible with the respective flash mode.

Wireless functions

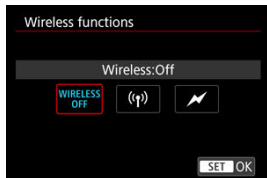

You can use radio or optical wireless transmission to shoot with wireless multiple-flash lighting.

For details on wireless flash, refer to the Instruction Manual of a Speedlite compatible with wireless flash photography.

Firing ratio control (RATIO)

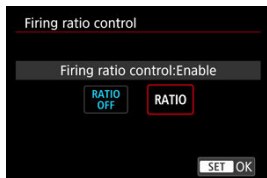

With a macro flash, you can set the firing ratio control.
For details on firing ratio control, refer to the Instruction Manual of the macro flash.

Flash zoom (flash coverage)

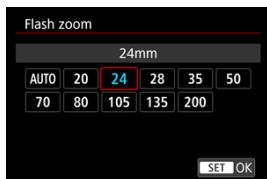

With Speedlites having a zooming flash head, you can set the flash coverage.

Shutter synchronization

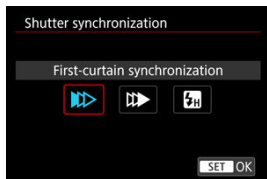

Normally, set this to **[First-curtain synchronization]** so that the flash fires immediately after the shooting starts.

Set to **[Second-curtain synchronization]** and use low shutter speeds for natural-looking shots of subject motion trails, such as car headlights.

Set to **[High-speed synchronization]** for flash photography at higher shutter speeds than the maximum flash sync shutter speed. This is effective when shooting with an open aperture in **[Av]** mode to blur the background behind subjects outdoors in daylight, for example.

Caution

- When using second-curtain synchronization, set the shutter speed to 1/30 sec. or slower. If the shutter speed is 1/40 sec. or faster, first-curtain synchronization will be applied automatically even if **[Second-curtain synchronization]** is set.
- Shutter speed is set to 1/8000 when **[Shutter mode]** is **[Electronic \overline{EES}]** and **[High-speed synchronization]** is selected with a shutter speed of 1/8000 sec. or faster.

Flash exposure compensation

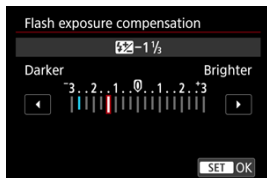

Just as exposure compensation is adjustable, you can also adjust flash output.



Note

- If flash exposure compensation is set with the Speedlite, you cannot set the flash exposure compensation with the camera. If it is set with both the camera and Speedlite, the Speedlite's setting overrides the camera's.

Flash exposure bracketing

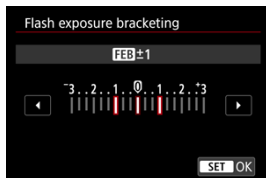

Speedlites equipped with flash exposure bracketing (FEB) can change the external flash output automatically as three shots are taken at once.

Flash Custom Function Settings

For details on the Speedlite's Custom Functions, refer to the Instruction Manual of the Speedlite.

1. Select [Flash C.Fn settings].

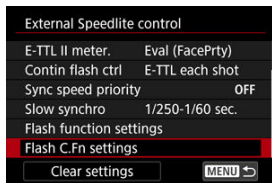

2. Set the desired functions.

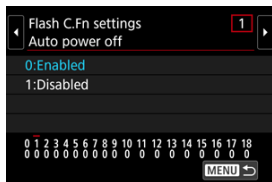

- Select the number.
- Select an option.

⚠ Caution

- EX series Speedlites always fire at full output when the [Flash metering mode] Custom Function is set to [1:TTL] (autoflash).
- The Speedlite's Personal Function (P.Fn) cannot be set or canceled from the camera's [📷: External Speedlite control] screen. Set it directly on the Speedlite.

Clearing Flash Function Settings/Clearing All Speedlite Custom Functions

1. Select [Clear settings].

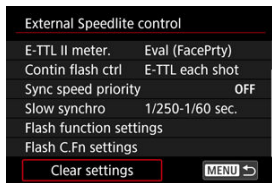

2. Select the settings to be cleared.

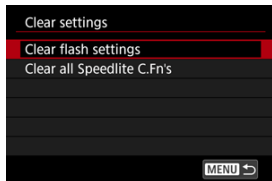

- Select [Clear flash settings] or [Clear all Speedlite C.Fn's].
- Select [OK] on the confirmation screen to clear all flash settings or Custom Function settings.

[Picture Style Characteristics](#)

[Symbols](#)

Just by selecting a preset Picture Style, you can obtain image characteristics effectively matching your photographic expression or the subject.

In **[A+]** mode, **[A]** (Auto) is set automatically.

1. Select **[Picture Style]** (, )

2. Select a Picture Style.

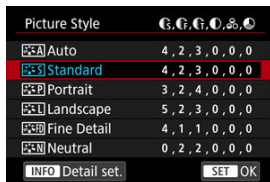

Picture Style Characteristics

-  **Auto**

The color tone will be adjusted automatically to suit the scene. The colors will look vivid for blue skies, greenery and sunsets, particularly in nature, outdoor, and sunset scenes.

 **Note**

- If the desired color tone is not obtained with **[Auto]**, use another Picture Style.

-  **Standard**

The image looks vivid, sharp, and crisp. Suitable for most scenes.

-  **Portrait**

For smooth skin tones, with slightly less sharpness. Suited for close-up portraits. Skin tone can be adjusted by changing **[Color tone]** as described in [Settings and Effects](#).

-  **Landscape**

For vivid blues and greens, and very sharp and crisp images. Effective for impressive landscapes.

-  **Fine Detail**

For detailed rendering of fine subject contours and subtle textures. The colors will be slightly vivid.

-  **Neutral**

For retouching later on a computer. Makes images subdued, with lower contrast and natural color tones.

-  **Faithful**

For retouching later on a computer. Faithfully reproduces the actual colors of subjects as measured in daylight with a color temperature of 5200K. Makes images subdued, with lower contrast.

-  **Monochrome**

Creates black-and-white images.









 **Caution**

- Color images cannot be recovered from JPEG/HEIF images shot with the **[Monochrome]** Picture Style.

-  **User Def. 1–3**

You can add a new style based on presets such as **[Portrait]** or **[Landscape]** or a Picture Style file, then adjust it as needed (). With any User Defined Picture Style that has not yet been registered, pictures will be taken with the same characteristics settings as with the default settings of **[Standard]**.

 **Caution**

-  **Auto** and the options from  **User Def. 1** to  **User Def. 3** are not available when   **HDR shooting (PQ)** is set to **[HDR PQ]**.
-  **Auto** is not available when  **Focus bracketing** is set to **[Enable]**. This also changes **[Picture Style]** for the options from  **User Def. 1** to  **User Def. 3** to **[Auto]**.

Symbols

Icons on the Picture Style selection screen represent **[Strength]**, **[Fineness]**, and **[Threshold]** for **[Sharpness]** as well as **[Contrast]** and other parameters. The numbers indicate the values for these settings specified for the respective Picture Style.

Picture Style		Picture Style	
Auto	4, 2, 3, 0, 0, 0	Neutral	0, 2, 2, 0, 0, 0
Standard	4, 2, 3, 0, 0, 0	Faithful	0, 2, 2, 0, 0, 0
Portrait	3, 2, 4, 0, 0, 0	Monochrome	4, 2, 3, 0, N, N
Landscape	5, 2, 3, 0, 0, 0	User Def. 1	Standard
Fine Detail	4, 1, 1, 0, 0, 0	User Def. 2	Standard
Neutral	0, 2, 2, 0, 0, 0	User Def. 3	Standard
INFO Detail set.		INFO Detail set.	

	Sharpness		
			Strength
			Fineness
			Threshold
	Contrast		
	Saturation		
	Color tone		
	Filter effect (Monochrome)		
	Toning effect (Monochrome)		

Caution

- For movie recording, "**" is indicated for the **[Fineness]** and **[Threshold]** parameters of **[Sharpness]**. **[Fineness]** and **[Threshold]** cannot be set for movie recording.

☑ [Settings and Effects](#)

☑  [Monochrome Adjustment](#)

You can customize any Picture Style by changing it from the default settings. For details on customizing [**Monochrome**], see  [Monochrome Adjustment](#).

1. Select [: Picture Style] (, ).
2. Select a Picture Style.



- Select the Picture Style to adjust, then press the <INFO> button.

3. Select an option.

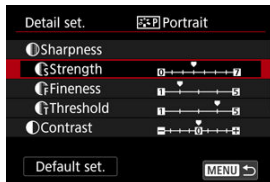

- Select an option, then press <SET>.
- For details on settings and effects, see [Settings and Effects](#).

4. Set the effect level.

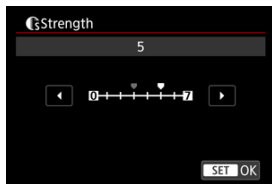

- Adjust the effect level, then press < **SET** >.









- Press the < **MENU** > button to save the adjusted setting and return to the Picture Style selection screen.
- Any settings you change from default values are displayed in blue.

Note

- For movie recording, **[Fineness]** and **[Threshold]** for **[Sharpness]** cannot be set (not displayed).
- By selecting **[Default set.]** in step 3, you can restore the parameter settings of the respective Picture Style to the defaults.
- To shoot with the Picture Style you adjusted, first select the adjusted Picture Style, then shoot.

Settings and Effects

	Sharpness			
		Strength	0: Weak outline emphasis	7: Strong outline emphasis
		Fineness^{*1}	1: Fine	5: Grainy
		Threshold^{*2}	1: Low	5: High
	Contrast	-4: Low contrast	+4: High contrast	
	Saturation	-4: Low saturation	+4: High saturation	
	Color tone	-4: Reddish skin tone	+4: Yellowish skin tone	

* 1: Indicates the edge thinness that enhancement applies to. The smaller the number, the finer the outlines that can be emphasized.

* 2: Contrast threshold between edges and surrounding image areas, which determines edge enhancement. The smaller the number, the more the outline will be emphasized when the contrast difference is low. However, noise tends to be more noticeable when the number is smaller.

Filter effect

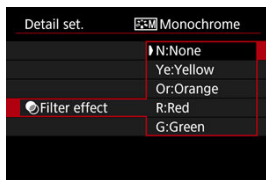

Even with the same monochrome image, you can make white clouds, green trees, or other elements stand out more by applying a filter effect.

Filter	Sample Effects
N:None	Normal black-and-white image with no filter effects.
Ye:Yellow	Blue sky will look more natural, and white clouds will look crisper.
Or:Orange	The blue sky will look slightly darker. The sunset will look more brilliant.
R:Red	The blue sky will look quite dark. Fall leaves will look crisper and brighter.
G:Green	Skin tones and lips will appear muted. Green tree leaves will look crisper and brighter.

Note

- Increasing **[Contrast]** will make the filter effect more pronounced.

Toning effect

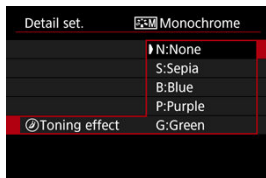

By applying a toning effect, you can create a monochrome image in the selected color. Effective when you want to create memorable images.

4. Select a base Picture Style.

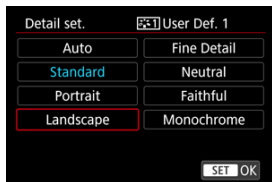

- Select the base Picture Style, then press < **SET** >.
- Also select styles this way when adjusting styles registered to the camera with EOS Utility (EOS software).

5. Select an option.

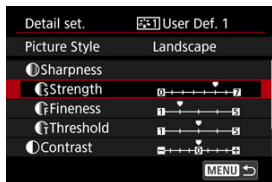

- Select an option, then press < **SET** >.

6. Set the effect level.

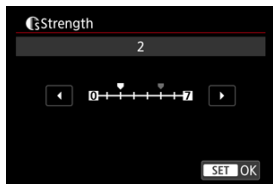

- Adjust the effect level, then press < **SET** >.
- For details, see [Picture Style Customization](#).

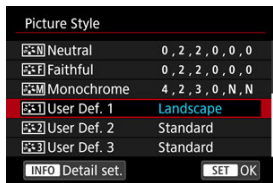

- Press the < **MENU** > button to save the adjusted setting and return to the Picture Style selection screen.
- The base Picture Style will be indicated on the right of [**User Def. ***].
- Blue style names in [**User Def. ***] have been changed from default values.

Caution

- If a Picture Style is already registered under [**User Def. ***], changing the base Picture Style will clear the parameter settings of the previously registered User Defined Picture Style.
- You can restore the default [**User Def. ***] style and settings by selecting [**Basic settings**] in [**Reset camera**].





Note

- To shoot with a registered Picture Style, select the registered [**User Def. ***], then shoot.
- For instructions on registering a Picture Style file to the camera, refer to the EOS Utility Instruction Manual.



[ **HDR shooting (PQ)**] enables you to capture HDR images conforming to the PQ specification (referring to the input signal gamma curve for HDR image display) defined in ITU-R BT.2100 and SMPTE ST.2084.

Note

- Captured as HEIF or RAW images.
- For optimal viewing, use an HDR display device.
- Display varies depending on monitor performance.

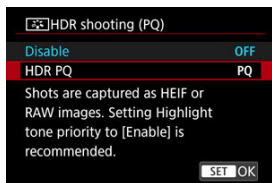
1. Select [:  **HDR shooting (PQ)**] (, ).
2. Select [**HDR PQ**].



- [ **V Assist**] and [ **HDR PQ**] icons are shown on the screen.
- For display on the camera screen, images are converted to resemble how they would look on an HDR display device.

Caution

- [**HDR PQ**] is not available with [: **Main rec. format**] set to [**XF-AVC S YCC420 8bit**].
- Appearance on HDR and non-HDR display devices may vary.
- Image areas shown in gray in the histogram roughly indicate signal values that are not used.
- [:  **Display frame rate set.**] is automatically set to [**Smooth**].

☑ Adobe RGB

The range of reproducible colors is called the “color space.” For normal shooting, sRGB is recommended.

In [**AF**] mode, [**sRGB**] is set automatically.

1. Select [**Color space**] (☑).
2. Set a color space option.

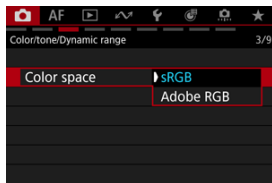

- Select [**sRGB**] or [**Adobe RGB**], then press < **SET** >.

Adobe RGB

This color space is mainly used for commercial printing and other professional applications. Recommended when using equipment such as Adobe RGB-compatible monitors or DCF 2.0 (Exif 2.21 or later) compatible printers.

Note

- File names of still photos shot in the Adobe RGB color space begin with “_”.
- The ICC profile is not appended. For the descriptions about the ICC profile, refer to the Digital Photo Professional Instruction Manual (EOS software).

You can adjust image clarity, as determined by the contrast of image edges. Set toward the negative end to make images look softer or toward the positive end for a sharper appearance.

1. Select [📷: Clarity] (🔍, 🔍).
2. Set the effect level.



⚠ Caution

- Setting clarity may darken or lighten the areas around boundaries in high-contrast images.
- The effect of this setting is not shown in images on the screen in still photo shooting.

Brightness and contrast can be corrected automatically if shots look dark or contrast is too low or high.

In **[A+]** mode, **[Standard]** is set automatically.

1. Select **[📷: Auto Lighting Optimizer]** (🔍, 🔍).
2. Set a correction option.



⚠ Caution

- Noise may increase and apparent resolution may change, under some shooting conditions.
- If the effect of Auto Lighting Optimizer is too strong and results are not at your preferred brightness, set to **[Low]** or **[Disable]**.
- If a setting other than **[Disable]** is set and you use exposure compensation or flash exposure compensation to darken the exposure, the image may still come out bright. If you want a darker exposure, set this function to **[Disable]**.

📄 Note

- To enable **[📷: Auto Lighting Optimizer]** to be set even in **[M]** and **[BULB]** modes, press the **<INFO>** button in step 2 to clear the checkmark **[✓]** for **[Disabled in M or B modes]**.

You can reduce overexposed, clipped highlights.

1. Select [: Highlight tone priority] (,).

2. Set an option.

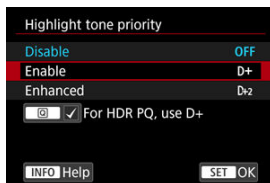

- **[Enable]**: Improves gradation in highlights. The gradation between the grays and highlights becomes smoother.
- **[Enhanced]**: Reduces overexposed highlights even more than **[Enable]**, under some shooting conditions.

! Caution

- Noise may increase slightly.
- The available ISO range starts at ISO 200. Expanded ISO speeds cannot be set.
- With **[Enhanced]**, results in some scenes may not look as expected.

📄 Note

- [: Highlight tone priority] is set to **[Enable]** and cannot be changed when you set [: HDR shooting (PQ)] to **[HDR PQ]** after pressing the < > button to add a checkmark to this setting.

☑ [White Balance](#)

☑ [\[AWB/AWBW\] Auto White Balance](#)

☑ [\[K\] Setting a Color Temperature](#)

White balance (WB) is for making the white areas look white. Normally, [Auto White Balance (AWB/AWBW)] provides suitable white balance. If natural-looking colors cannot be obtained with auto white balance, you can select the white balance to match the light source or set it manually by shooting a white object.

In [A+] mode, [AWB] (auto white balance) is set automatically.

1. Select [📷: White balance] (🔍, 📷).

2. Select a white balance setting.













- Turn the <🔍> dial to make a selection.

Note

- For [AWB] and [AWBW] setting instructions, see [\[AWB/AWBW\] Auto White Balance](#).
- To set a suitable white balance for the light source of the shooting location, select [📷] and turn the <🔍> dial to set an MWB number (🔍).
- To set a color temperature directly, select [K], then turn the <🔍> dial (🔍).
- To adjust the current white balance, press the <INFO> button after selecting the light source, then adjust as needed (🔍).
- White balance settings cannot be changed while you are pressing the movie shooting button to record a movie.
- Movie Exif information will include the white balance setting value at the time recording began.

(Approx.)

Display	Mode	Color Temperature (K: Kelvin)
	Auto: Ambience priority	3000–7000
	Auto: White priority	
	Daylight	5200
	Shade	7000
	Cloudy, twilight, sunset	6000
	Tungsten light	3200
	White fluorescent light	4000
	When using Flash	Automatically set*
	Custom	2000–10000
	Color temperature	2500–10000

* Applicable with Speedlites having a color temperature transmission function. Otherwise, it will be fixed to approx. 6000K.

White Balance

The human eye adapts to changes in lighting so that white objects look white under all kinds of lighting. Digital cameras determine white from the color temperature of lighting and, based on this, apply image processing to make color tones look natural in your shots.

[AWB/AWBW] Auto White Balance

With [AWB] (Ambience priority), you can slightly increase the intensity of the image's warm color cast when shooting a tungsten-light scene.

If you select [AWBW] (White priority), you can reduce the intensity of the image's warm color cast.

1. Select [📷: White balance] (🔗, 🔗).
2. With [AWB] selected, press the <INFO> button.



3. Select an option.

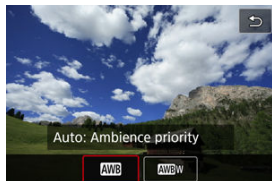

⚠ Caution

Precautions when set to [AWBW] (White priority)

- The warm color cast of subjects may fade.
- When multiple light sources are included in the scene, the warm color cast of the picture may not be reduced.
- When using flash, the color tone will be the same as with [AWB] (Ambience priority).

[K] Setting a Color Temperature



A value can be set representing the white balance color temperature.

1. Access the WB screen.

- Follow steps 1–2 in [White Balance](#).

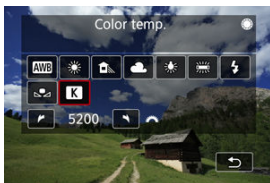
2. Set the color temperature.



- With [K] selected, turn the <  > dial to select a color temperature.
- Press <  > to exit the setting.

Note

- When setting the color temperature for an artificial light source, set the white balance correction (magenta or green bias) as necessary.
- When setting [K] to a value measured with a commercially available color temperature meter, take some test shots in advance and adjust the setting as needed to compensate for any difference between the color temperature meter and the camera.

☑ [Registering Custom White Balances](#)

☑ [Selecting and Shooting with Custom White Balances](#)

☑ [Naming Custom White Balances](#)

With custom white balance, you can set the white balance using an image captured under the same lighting as at the shooting location.

Registering Custom White Balances

To register custom white balances, you can either register a picture taken during this process or register an image recorded on a card.

Note

- Up to five custom white balances can be registered to the camera.
- Register separate custom white balances for still photos and movies, as needed.

Registering by shooting on-site

Registration from the Quick Control screen

1. Press the **< Q >** button.

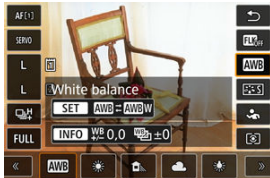

- Select the **[White balance]** setting item.

2. Select [Custom].

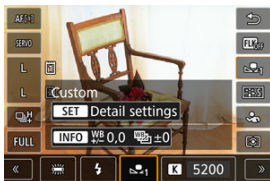

- Select [], then press < >.

3. Select a custom white balance number to register the white balance data to.

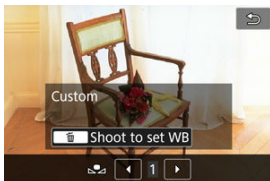

- Turn the < > dial or press < > left or right to select a number from 1 to 5, then press the < > button.

4. Shoot a plain white object ().



- The custom white balance is registered to the camera.
- To shoot with the registered custom white balance, see [Selecting and Shooting with Custom White Balances](#).

1. Select [📷: Set Custom WB] (🔍, 🔍).
2. Select a custom white balance number to register the white balance data to.

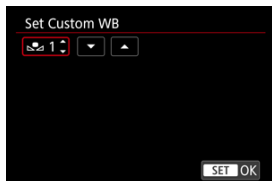

- Press <ⓘ>.
- Turn the <🌀> dial or press <⚙> up or down to select a number for [📷] (from 1 to 5), then press <ⓘ>. The custom white balance will be registered to the selected number.

3. Select [Record and register WB].

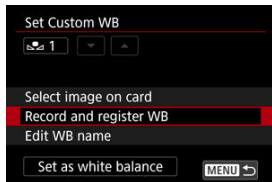

4. Shoot a plain white object (☑).

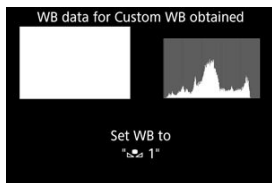
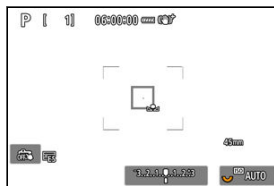

- The custom white balance is registered to the camera.
- To shoot with the registered custom white balance, see [Selecting and Shooting with Custom White Balances](#).

Registering from an existing image on a card

1. Shoot a plain white object.
 - Shoot a plain white object as described in [Shooting to register custom white balances](#).
2. Select [📷: Set Custom WB] (📷, 📷).
3. Select a custom white balance number to register the white balance data to.

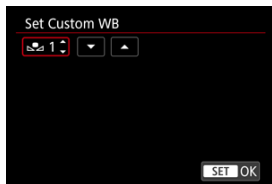

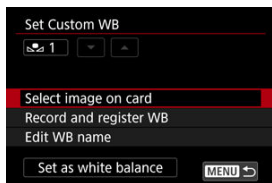

- Press <SET>.
 - Turn the <🌀> dial or press <📷> up or down to select a number for [📷] (from 1 to 5), then press <SET>. The custom white balance will be registered to the selected number.
4. Select [Select image on card].



- Images recorded on the card are displayed.

5. Select an image to register as the custom white balance.



- Turn the <  > dial to select the image captured in step 1, then press <  >.

6. Register the image data as a custom white balance on the camera.

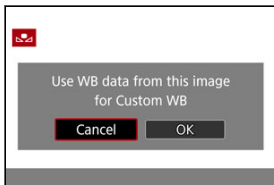

- Select [**OK**] after the message, and your custom white balance will be registered to the camera.
- To shoot with the registered custom white balance, see [Selecting and Shooting with Custom White Balances](#).

 **Caution**

- If the exposure obtained in step 1 differs greatly from the standard exposure, a correct white balance may not be obtained.
- The following images cannot be selected.
 - Images captured with Picture Style set to [**Monochrome**]
 - Multiple exposures
 - Cropped images
 - Images from other cameras

Shooting to register custom white balances

Note the following when shooting a plain white object to register the color as a custom white balance.

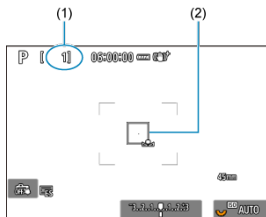

- Your selected number (1) blinks in the upper left of the screen and on the LCD panel.
- Aim the camera at a plain white object so that white fills the area in (2).
- Set the camera to [Manual Focus](#) and shoot so that the white object has standard exposure.
- You can use any of the white balance settings.

Caution

- Correct white balance may not be obtained if the exposure of your image differs greatly from standard exposure.

Note

- If **[Correct WB may not be obtained with the selected image]** is displayed, try shooting again from step 1.
- Instead of shooting a white object, you can also shoot a gray card or standard 18% gray reflector (commercially available).
- Images captured for this purpose are not recorded to a card.

Selecting and Shooting with Custom White Balances

Setting from the Quick Control screen

1. Press the **< Q >** button.

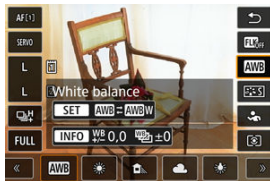

- Select the **[White balance]** setting item.

2. Select **[Custom]**.

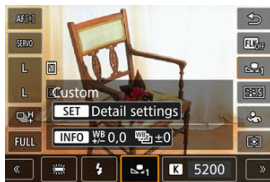

3. Select the custom white balance number.

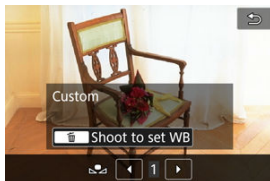

- Turn the **< dial >** or press **< * >** left or right to select a number from 1 to 5, then press **< SET >**.

4. Take the picture.

Setting from the menu

1. Select [📷: Set Custom WB] (🔍, 🔍).

2. Select the custom white balance number.



(1) Registered image

- On the [Set Custom WB] screen, select the number of the registered custom white balance.

3. Select [Set as white balance].

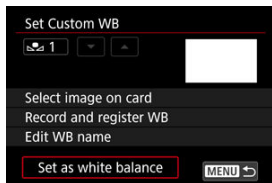

- The white balance setting changes to [📷*].

4. Take the picture.

- The picture is taken with the [📷*] setting applied.

Naming Custom White Balances

You can add a name (caption) to the five registered custom white balances (custom white balance nos. 1–5).

1. Select [📷: Set Custom WB] (🔗, 🔗).
2. Select the custom white balance number.

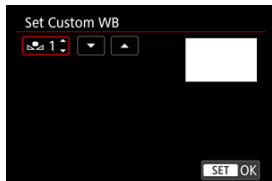

- On the [Set Custom WB] screen, select the number of the registered custom white balance to add a name to.

3. Select [Edit WB name].

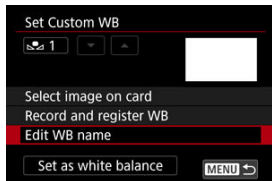

4. Enter text.



- Use < [] >, < [] >, or < [] > to select a character, then press < [] > to enter it.
- By selecting [[]], you can change the input mode.
- To delete single characters, select [[]] or press the < [] > button.

5. Exit the setting.

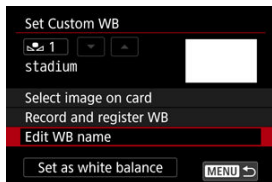

- Press the < [] > button, then press [[]].
- The information is saved, and display returns to the screen in step 2.
- The entered name is displayed below [[]].

Note



- As names, it may be helpful to enter the names of places where you captured the custom white balance images, or the names of the light sources.

 [White Balance Correction](#)

 [White Balance Auto Bracketing](#)

You can correct the white balance that is set. This adjustment will have the same effect as using a commercially available color temperature conversion filter or color compensating filter.

White Balance Correction

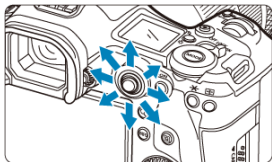

1. Select [: WB Shift/Bkt.] (, ).

2. Set the white balance correction.



Sample setting: A2, G1



- Use <  > to move the "■" mark on the screen to your preferred position.
- B is for blue, A for amber, M for magenta, and G for green. White balance is corrected in the direction you move the mark.
- The direction and amount of correction are indicated in the upper right of the screen.
- Pressing the <  > button will cancel all the [WB Shift/Bkt.] settings.
- Press <  > to exit the setting.

Note

- One level of the blue/amber correction is equivalent to approx. 5 mireds of a color temperature conversion filter. (Mired: Unit of measure for color temperature used to indicate values such as the density of a color temperature conversion filter.)

White Balance Auto Bracketing

White balance bracketing (WB Bkt.) enables you to capture three images at once with different color tones.

1. Select [📷: WB Shift/Bkt.] (🔍, 📷).

2. Set the white balance bracketing amount.

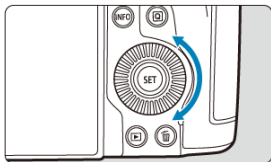

Sample setting: B/A bias, ± 3 levels



- Turning the <📷> dial changes the "■" mark on the screen to "■■■" (3 points). Turning the dial clockwise sets the B/A bracketing, and turning it counterclockwise sets the M/G bracketing.
- The direction and amount of bracketing are indicated in the upper right of the screen.
- Pressing the <📷> button will cancel all the [WB Shift/Bkt.] settings.
- Press <SET> to exit the setting.

⚠ Caution

- During white balance bracketing, the maximum burst for continuous shooting will be lower.
- Recording images to the card takes longer than in normal shooting.





Note

- The bracketing sequence is (1) Standard white balance, (2) Blue (B) bias, and (3) Amber (A) bias, or (1) Standard white balance, (2) Magenta (M) bias, and (3) Green (G) bias.
- You can also set white balance correction and AEB together with white balance bracketing.
- The white balance icon blinks to indicate that white balance bracketing has been set.
- You can change the bracketing sequence (☑) and number of shots (☑) for the white balance bracketing.
- Bracket stands for bracketing.

- [Peripheral Illumination Correction](#)
- [Distortion Correction](#)
- [Focus Breathing Correction](#)
- [Digital Lens Optimizer](#)
- [Chromatic Aberration Correction](#)
- [Diffraction Correction](#)

Vignetting, image distortion, and other issues may be caused by lens optical characteristics. The camera can compensate for these phenomena by using [**Lens aberration correction**].

1. Select [: Lens aberration correction] (, ).
2. Select an option.

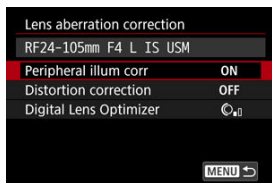

3. Select a setting.

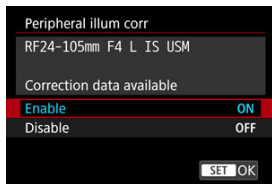

- Confirm that the name of the attached lens and [**Correction data available**] are displayed.
- If [**Correction data not available**] or [] is displayed, see [Digital Lens Optimizer](#).

Peripheral Illumination Correction

Vignetting (dark image corners) can be corrected.

Caution

- Depending on shooting conditions, noise may appear on the image periphery.
- The higher the ISO speed, the lower the amount of correction will be.

Note

- The amount of correction applied will be lower than the maximum correction amount applied with Digital Photo Professional (EOS software).
- Peripheral illumination is corrected automatically in [A+] mode when correction data is registered on the camera.

Distortion Correction

Distortion (image warping) can be corrected.



Caution

- To correct distortion, the camera captures a narrower image area than the area seen in viewfinder shooting, which crops the image a little and slightly lowers the apparent resolution.
- Applying distortion correction may change the angle of view slightly.
- The amount of image cropped may vary between still photos and movies.



Note

- With RF lenses, distortion correction during movie recording is supported.

Focus Breathing Correction

Angle of view fluctuations from changes in focal position during movie recording can be reduced.

This feature can be configured when **[Distortion correction]** is set to **[Enable]**.

! Caution

- **[Focus breathing correction]** is not displayed in still photo shooting.
- Applying focus breathing correction will narrow the angle of view. The extent of narrowing depends on shooting conditions.
- Test focus breathing correction before use, because the image processing may affect apparent image resolution and noise.
- Optimal correction is applied based on the position of the focusing distance range switch on the lens. (The correction is also applied in MF mode.) Focus breathing correction is not applied to any difference between the actual focusing distance and the range of the switch.
- Movies with abrupt changes to the angle of view may be recorded if you move the focusing distance range switch during recording.
- Correction artifacts may occur, depending on the lens and shooting conditions.
- For details on lenses compatible with this feature, visit the Canon website ([@](#)).

Digital Lens Optimizer

Various aberrations from lens optical characteristics can be corrected, along with diffraction and low-pass filter-induced loss of resolution.

If **[Correction data not available]** or  is displayed by **[Digital Lens Optimizer]**, you can use EOS Utility to add the lens correction data to the camera. For details, refer to the EOS Utility Instruction Manual.

Caution

- Image processing after you shoot takes longer when set to **[High]** (which causes the access lamp to be illuminated longer).
- Maximum burst is lower with **[High]**. Image recording to the card also takes longer.
- Depending on shooting conditions, noise may be intensified together with the effects of correction. Image edges may also be emphasized. Adjust Picture Style sharpness or set **[Digital Lens Optimizer]** to **[Disable]** as needed before shooting.
- The higher the ISO speed, the lower the amount of correction will be.
- For movie recording, **[Digital Lens Optimizer]** will not appear. (Correction is not possible.)
- The effect of Digital Lens Optimizer cannot be checked on the screen at the time of shooting.

Note

- With **[Digital Lens Optimizer]** set to **[Standard]** or **[High]**, **[Chromatic aberr corr]** and **[Diffraction correction]** are not displayed, but they are both set to **[Enable]** for shooting.

Chromatic Aberration Correction

Chromatic aberration (color fringing around subjects) can be corrected.



Note

- [Chromatic aberr corr] is not displayed when [Digital Lens Optimizer] is set to [Standard] or [High].

Diffraction Correction

Diffraction (loss of sharpness caused by the aperture) can be corrected.

Caution

- Depending on shooting conditions, noise may be intensified together with the effects of correction.
- The higher the ISO speed, the lower the amount of correction will be.

Note

- "Diffraction correction" corrects degraded resolution not only from diffraction but also from the low-pass filter and other factors. Thus, correction is also effective for exposures with the aperture wide open.
- **[Diffraction correction]** is not displayed when **[Digital Lens Optimizer]** is set to **[Standard]** or **[High]**.

Caution

General precautions for lens aberration correction

- Lens aberration correction cannot be applied to existing JPEG/HEIF images.
- When using a non-Canon lens, setting the corrections to **[Disable]** is recommended even if **[Correction data available]** is displayed.
- Magnifying the periphery of the image may display parts of the image that will not be recorded.
- The amount of correction (except diffraction correction) is less for lenses that do not provide distance information.



Note

General notes for lens aberration correction

- Effects of lens aberration correction vary by lens and shooting conditions. Also, the effect may be difficult to discern depending on the lens used, shooting conditions, etc.
- If the correction is difficult to discern, magnifying and checking the image after shooting is recommended.
- Corrections are applied even when an extender or life-size converter is attached.
- If the correction data for the attached lens is not registered to the camera, the result will be the same as when the correction is set to **[Disable]** (except for diffraction correction).
- If necessary, refer to the EOS Utility Instruction Manual as well.

Noise such as dots of light or banding that tends to occur in long exposures at shutter speeds of one sec. or slower can be reduced.

1. Select [📷: Long exp. noise reduction] (🔗).
2. Set a reduction option.

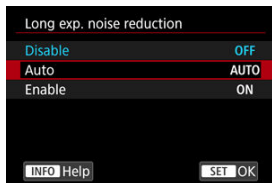

- **Auto**
For images exposed for 1 sec. or longer, noise reduction is performed automatically if noise typical of long exposures is detected. This setting is effective enough in most cases.
- **Enable**
Noise reduction is performed for all images exposed for 1 sec. or longer. The [Enable] setting may reduce noise that cannot be detected with the [Auto] setting.

⚠ Caution

- With [Auto] or [Enable] set, noise reduction after you shoot may take as long as exposure for the shot.
- Images may look grainier with the [Enable] setting than with the [Disable] or [Auto] setting.
- [BUSY] is displayed as noise is reduced, and the shooting screen is not displayed until processing is finished, when you can shoot again.

You can reduce the image noise generated. This function is especially effective when shooting at high ISO speeds. When shooting at low ISO speeds, the noise in the darker parts of the image (shadow areas) can further be reduced.

1. Select [📷: High ISO speed NR] (🔍, 📏).

2. Set the level.

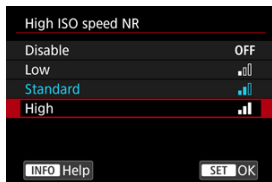

● **Low / Standard / High**

The camera applies an amount of noise reduction corresponding to your specified level.

 [Preparation](#)

 [Dust Delete Data Appending](#)

Dust Delete Data used to erase dust spots can be appended to images in case sensor cleaning leaves dust on the sensor. The Dust Delete Data is used by Digital Photo Professional (EOS software) to erase the dust spots automatically.

Preparation

- Use an RF or EF lens.
- Prepare a solid white object such as a sheet of paper.
- Set the lens focal length to 50 mm or longer.
- Set the lens's focus mode switch to <MF> and set the focus to infinity (∞). If the lens has no distance scale, rotate the camera to face toward you and turn the focusing ring clockwise all the way.

1. Select [: Dust Delete Data] ()

2. Select [OK].

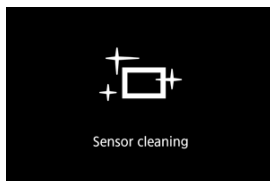
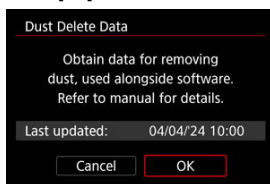

- After the automatic self-cleaning of the image sensor is performed, a message will appear. Although there will be a mechanical sound of the shutter during the cleaning, no picture is taken.

3. Shoot a plain white object.

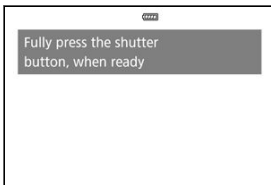

- Shoot with a plain white object (such as a new sheet of white paper) filling the screen, at a distance of 20–30 cm (0.7–1.0 ft.).
- Since the image will not be saved, the data can still be obtained even if there is no card in the camera.

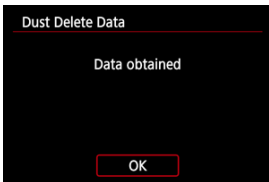

- When the picture is taken, the camera will start collecting the Dust Delete Data. When the Dust Delete Data is obtained, a message will appear.
- If the data is not obtained successfully, an error message will appear. Check the information in [Preparation](#), select **[OK]**, and shoot again.

Dust Delete Data Appending

The camera will append the Dust Delete Data obtained to all shots from now on. Acquiring Dust Delete Data immediately before shooting is recommended.

For details about using Digital Photo Professional (EOS software) to erase dust spots automatically, refer to the Digital Photo Professional Instruction Manual.

File size is essentially unaffected by Dust Delete Data appended to images.

Caution

- Dust Delete Data is not obtained when RF-S/EF-S lenses are used, or when [ **Cropping/aspect ratio**] is set to [**1.6x (crop)**].
- Dust Delete Data is not added to images when [**Distortion correction**] is set to [**Enable**].
- If the object has any pattern or design, it may be recognized as dust data and affect the accuracy of the dust deletion with the Digital Photo Professional (EOS software).

☑ [Merging Multiple Exposures with a JPEG Image Recorded on the Card](#)

☑ [Checking and Deleting Multiple Exposures During Shooting](#)

As you shoot multiple exposures (2–9), you can see how the images will be merged into a single image.

1. Select [: Multiple exposure] (☑).
2. Set [Multiple exposure].

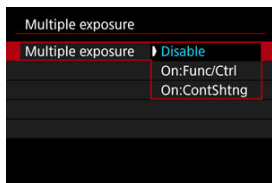

- Select an option, then press < >.
- To exit shooting multiple exposures, select [**Disable**].
- **On:Func/Ctrl**
Convenient when reviewing the results of each multiple exposure as you shoot. Continuous shooting speed is slower with this option.
- **On:ContShtng**
Used for continuous multiple exposures of moving subjects. These operations are not available during continuous shooting: menu screen display, image review after capture, image playback, and undo last image (☑).
Note that the single exposures used for merging are discarded, and only the multiple-exposure image is saved.

3. Set [Multi-expos ctrl].

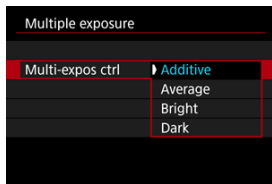

- Select a merging option, then press < (SET) >.

- **Additive**

The exposure of each single image captured is added cumulatively. Based on [**No. of exposures**], set negative exposure compensation. Follow these basic guidelines to set the exposure compensation amount.

Exposure compensation setting guidelines, by number of exposures

Two exposures: -1 stop, three exposures: -1.5 stops, four exposures: -2 stops

- **Average**

Based on the [**No. of exposures**], negative exposure compensation is set automatically as you shoot multiple exposures. In multiple exposures of the same scene, auto exposure control provides standard exposure behind the subject.

- **Bright/Dark**

Brightness (or darkness) of the base image and added images is compared at the same position, and bright (or dark) portions are retained. Some overlapping colors may be mixed, depending on the relative brightness (or darkness) of the images.

4. Set [No. of exposures].



- Select the number of exposures, then press < **SET** >.

5. Specify the images to save.

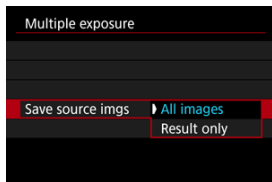

- To save all single exposures and the multiple-exposure image, select [**All images**] and press < **SET** >.
- To save only the multiple-exposure image, select [**Result only**] and press < **SET** >.

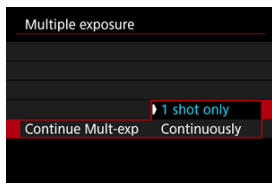

6. Set [Continue Mult-exp].



- Select an option, then press < (SET) >.
- With [**1 shot only**], multiple-exposure shooting will be canceled automatically after the shooting ends.
- With [**Continuously**], multiple-exposure shooting continues until the setting in step 2 is set to [**Disable**].

7. Shoot the first exposure.



- When [**On:Func/Ctrl**] is set, the captured image will be displayed.
- The [] icon blinks.
- The number of remaining exposures is indicated on the screen (1) for reference.
- Pressing the < [] > button enables you to view the captured image ().

8. Shoot the next exposures.

- Images captured so far are displayed merged. For only image display, press the < INFO > button repeatedly.
- Multiple-exposure shooting will end when the set number of exposures are taken.



Note

- With [On:Func/Ctrl], you can press the < [▶] > button to view the multiple-exposure image so far, and you can delete the previous single exposure (☒).
- As shooting information, the multiple-exposure image has information captured for the last shot.



Caution

- Image noise, color shift, or banding may be noticeable in multiple exposures, depending on subjects and shooting conditions.
- With multiple exposures, the more exposures there are, the more noticeable the noise, irregular colors, and banding will be.
- Multiple-exposure shooting is canceled if you set the power switch to < OFF > or switch batteries or cards.
- Multiple-exposure shooting ends if you set the shooting mode to [△+]/[C1]/[C2]/[C3] or switch to movie recording.
- If you connect the camera to a computer, multiple-exposure shooting will not be possible. If you connect the camera to a computer during shooting, multiple-exposure shooting will end.
- [☑: [☒]/☒ Display frame rate set.] is locked on [Smooth] when [Multiple exposure] is set to an option other than [Disable].



Merging Multiple Exposures with a JPEG Image Recorded on the Card

You can select a JPEG image recorded on the card as the first single exposure. The selected JPEG image will remain intact.

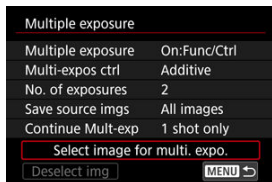
1. Select [Select image for multi. expo.].



2. Select the first image.

- Turn the <  > dial to select the first image, then press <  >.
- Select [OK].
- The file number of the selected image will be displayed at the bottom of the screen.



3. Take the picture.

- When you select the first image, the number of remaining exposures as set with **[No. of exposures]** will decrease by 1.



Images you can select

You can select a JPEG image shot at the same angle of view as the first selected JPEG.



- **Images captured at a full-frame angle of view**

Images captured using RF/EF lenses and with :  **Cropping/aspect ratio** set to **[Full-frame]**

- **Images captured at an APS-C angle of view**

- Images captured using RF/EF lenses and with :  **Cropping/aspect ratio** set to **[1.6x (crop)]**
- Images captured using RF-S/EF-S lenses

Caution

- The following images cannot be selected.
 - RAW or HEIF images
 - JPEG images in **M / S1 / S2** sizes
 - Images with :  **Cropping/aspect ratio** set to an option other than **[Full-frame]** or **[1.6x (crop)]**
 - Images from other cameras
- Images that cannot be merged may be displayed.

Note



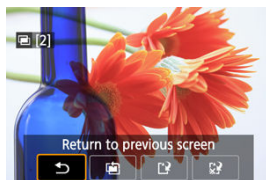

- You can also select a JPEG image used in multiple-exposure shooting.
- Select **[Deselect img]** to cancel image selection.
- The color space set for the first image also applies to subsequent images.

Checking and Deleting Multiple Exposures During Shooting



To view the multiple-exposure image so far, check exposure, and see how the images are merged, you can press the <  > button before you finish shooting your specified number of exposures (when [On:Func/Ctrl] is set, but not with [On:ContShtnng]).

Pressing the <  > button will display the operations possible during multiple-exposure shooting.

Option	Description
 Return to previous screen	The screen before you pressed the <  > button will reappear.
 Undo last image	Deletes the last image you shot (enabling you to replace it by shooting again). The number of remaining exposures will increase by 1.
 Save and exit	With [Save source imgs: All images], saves all single exposures and the multiple-exposure image created so far and exits multiple-exposure shooting. With [Save source imgs: Result only], saves only the multiple-exposure image created so far and exits multiple-exposure shooting.
 Exit without saving	Exits the multiple-exposure shooting without saving the image.

Caution

- During multiple-exposure shooting, you can only play back multiple-exposure images.

? FAQ

- **Are there any restrictions on the image quality?**

Multiple exposures are captured as JPEG [L : 8] images. Even when [📷: **Img type/size**] is set to RAW only, these images are captured as JPEG [L : 8] images.

- **Can I merge images recorded on the card?**

With [**Select image for multi. expo.**], you can select the first single exposure from the images recorded on the card (🔗). Note that you cannot merge multiple images already recorded on the card.

- **How are multiple-exposure files numbered?**

With the camera set to save all images, multiple-exposure image files are named with the next number after the number of the last single exposure used to create them.

- **Will auto power off take effect during multiple-exposure shooting?**

During multiple-exposure shooting, auto power off will not take effect. Note that before you start multiple-exposure shooting, auto power off automatically takes effect at the time set in the [**Auto power off**] option of [🔋: **Power saving**], which will cancel multiple-exposure shooting.

Focus bracketing enables continuous shooting with the focal distance changed automatically after each shot. These images enable you to create a single image in focus over a deep depth of field. Compositing is also possible using an application that supports depth compositing, such as Digital Photo Professional (EOS software).

1. Select [📷: Focus bracketing] (🔗).

2. Set [Focus bracketing].

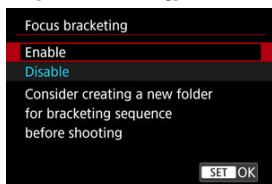

- Select [Enable].

3. Set [Number of shots].



- Specify the number of images captured per shot.
- Can be set in a range of [2]–[999].

4. Set [Focus increment].

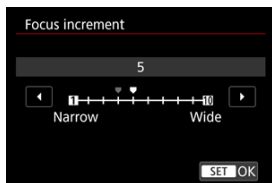

- Specify how much to shift the focus. This amount is automatically adjusted to suit the aperture value at the time of shooting. Larger aperture values increase the focus shift and make focus bracketing cover a wider range under the same focus increment and number of shots.
- After completing the settings, press < (SET) >.

5. Set [Exposure smoothing].

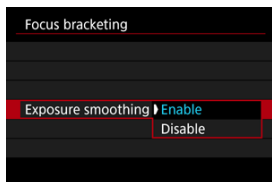

- You can compensate for changes in image brightness during focus bracketing by selecting **[Enable]**, so that the camera makes adjustments based on differences between the displayed and actual aperture value (effective *f*/number), which varies by focal position.
- Select **[Disable]** if you prefer not to compensate for changes in image brightness during focus bracketing. Use this option for purposes other than depth compositing of the captured images in applications such as DPP.

6. Set [Depth composite].

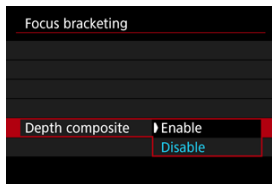

- Select **[Enable]** for in-camera depth compositing. Both the depth-composited image and the source images are saved.
- Select **[Disable]** if you prefer not to perform in-camera depth compositing. Only captured images are saved.

7. Set [Crop depth comp.].

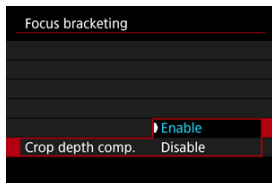

- Select **[Enable]** for cropping before compositing, to prepare any images without a sufficient angle of view for compositing alignment by cropping them to correct the angle of view.
- Select **[Disable]** if you prefer not to crop these images. In this case, areas without a sufficient angle of view are covered by a black border in the saved images. You can crop the images manually or edit them as needed.

8. Set [Flash interval].

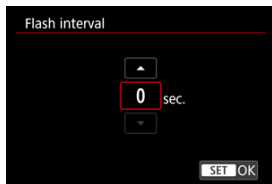





- Focus bracketing is available with compatible Speedlites, and with non-Canon flash units fired via the sync terminal.
- When set to [0], compatible Speedlites fire and the camera shoots as soon as the Speedlites are fully charged. Refer to the instruction manual of compatible Speedlites for precautions on continuous firing. Consider setting a longer interval when using multiple compatible Speedlites in wireless flash photography.
- With non-Canon flash units, set a suitable interval time for the flash recharging time and durability. Also refer to [Non-Canon Flash Units](#).

9. Take the picture.

- To save your shots in a new folder, tap [**■**] and select [OK].
- Focus at the nearer end of your preferred focal range, then press the shutter button completely.
- Once shooting begins, release the shutter button.
- The camera shoots continuously, shifting the focal position toward infinity.
- Shooting ends after your specified number of images, or at the far end of the focal range.
- To cancel shooting, press the shutter button completely again.





Caution

- For best results, shoot subjects that are not moving. Using a tripod, remote switch (sold separately, ) , or wireless remote control (sold separately, ) is recommended.
- Shooting with a wider angle of view is recommended. After depth compositing, you can crop the image if necessary.
- For details on lenses and flash units compatible with this feature, visit the Canon website () .
- Suitable [**Focus increment**] settings vary by subject. An unsuitable [**Focus increment**] setting may cause unevenness in composite images, or shooting may take more time because more shots are taken. Take some test shots to decide a suitable [**Focus increment**] setting.
- Shooting under flickering light may cause uneven images. In this case, lowering the shutter speed may give better results.
- Focus bracketing is not available when the camera is set to manual focus () .
- Canceling shooting in progress may cause exposure problems in the last image. Avoid using the last image when combining the images in Digital Photo Professional.
- Maximum shutter speed with focus bracketing is 1/8000 sec.
- Flash sync shutter speed in focus bracketing is 1/125 sec. (for [**Full-frame**]) or 1/200 sec. (for [**1.6x (crop)**]).
- Depth compositing is canceled if you open the battery compartment or card slot cover, or if the remaining battery capacity becomes too low. After cancellation, composited images are not saved.
- Depth compositing may fail for patterned images (with a lattice or stripes, for example) or images that are generally flat and uniform.
- When taking several shots, start by focusing closer, then gradually focus farther away.
- Too great a distance when moving the focal position between multiple shots may cause unevenness in depth-composited images, or it may cause compositing to fail.
- Depth compositing is intended for subjects that are not moving. For this reason, shooting subjects in motion may prevent effective compositing.
- Depth compositing of images with multiple subjects may fail if your shots are composed with the subjects far apart from each other, for example.
- To cancel depth compositing in progress, press the < **INFO** > button. Cancellation discards the composited image but keeps all source images.
- In depth compositing, optimal images from the shots are selected and combined by the camera. Not all of the shots are combined to create the composite image.



Note

- For best results, set the aperture value in a range of f/5.6–11 before shooting.
- Details such as shutter speed, aperture value, and ISO speed are determined by conditions for the first shot.
- : [**Focus bracketing**] reverts to [**Disable**] when the power switch is set to < **OFF** > .

Depth compositing image quality setting and images saved

- Composited images are saved as JPEG or HEIF images with **L** image quality. RAW composited images are not produced.
- When [ **Rec options**] in [: **Record func+card/folder sel.**] is set to [**Rec. separately**], source images for both slots are saved with the same image quality as set for the card selected in [ **Play**] in the [: **Record func+card/folder sel.**] setting.

With this feature, automatic shooting in continuous shooting drive mode is already in progress before you press the shutter button completely, after you have pressed it halfway for a moment. [PRE ] is displayed on the shooting screen during pre-continuous shooting.

1. Select [: Pre-cont. shooting] ().
2. Select [Enable].

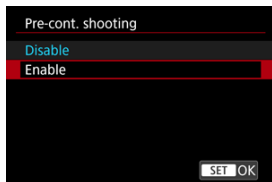

Caution

- Use cards with 4 GB or more of free space.
- The shutter-release time lag and continuous shooting interval may vary.
- The number of shots available may not match the number displayed.
- Subjects may be out of focus if there are sudden changes in the distance between subjects and the camera while you are pressing the shutter button halfway.
- Images may not be captured correctly when you use pre-continuous shooting with a low battery.
- Shutter speeds slower than [0"5] (0.5 sec.) are not available.
- In [M] mode, consider shooting with ISO Auto.
- With variable maximum aperture zoom lenses, exposure may change if you zoom while pressing the shutter button halfway or completely.
- Even with constant maximum aperture zoom lenses, exposure may change if you zoom while pressing the shutter button halfway or completely. For details, refer to the Canon website ().





Note

- The electronic shutter is used in shooting.
- The amount of preliminary shooting varies depending on the continuous shooting speed. (For example, at a continuous shooting speed of approx. 30 shots/sec., the camera shoots for about 0.5 sec. before you press the button completely.)

Interval Timer Shooting

With the interval timer, you can set the shooting interval and number of shots, so that the camera takes individual shots repeatedly according to your interval until your specified number of shots are taken.

1. Select [: Interval timer] ().
2. Select [Enable].

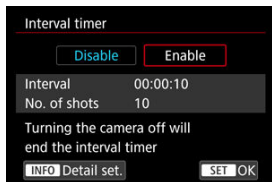

- Select [Enable], then press the < INFO > button.

3. Set the shooting interval and number of shots.

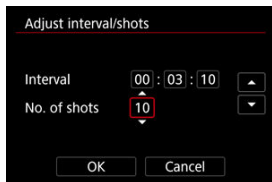

- Select an option to set (hours : minutes : seconds / number of shots).
- Press < **SET** > to display [**↑**].
- Set the desired number, then press < **SET** >. (Returns to [**□**].)
- **Interval**
Can be set in a range of [00:00:01]–[99:59:59].
- **No. of shots**
Can be set in a range of [01]–[99]. To keep the interval timer on indefinitely until you stop it, set [00].

4. Select [OK].

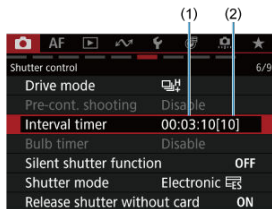

- The interval timer settings will be displayed on the menu screen.
(1) Interval
(2) Number of shots

5. Take the picture.

- First shot is taken and shooting continues according to the interval timer settings.
- During interval timer shooting, **[TIMER]** will blink.
- After the set number of shots are taken, the interval timer shooting will stop and be automatically canceled.



Note

- Using a tripod is recommended.
- Taking test shots in advance is recommended.
- Even during interval timer shooting, you can still shoot as usual by pressing the shutter button completely. Note that the camera will prepare for the next interval timer shot approx. 5 sec. in advance, which will temporarily prevent operations such as adjusting shooting settings, accessing menus, and playing back images.
- If the next scheduled interval timer shot is not possible because the camera is shooting or processing images, it will be skipped. For this reason, fewer shots than specified will be taken.
- Even during interval timer operation, auto power off is triggered after approx. 8 sec. of inactivity, as long as **[Auto power off]** under **[P: Power saving]** is not set to **[Disable]**.
- Can also be combined with AEB, white balance bracketing, and multiple exposures.
- To stop interval timer shooting, select **[Disable]** or set the power switch to **<OFF>**.

Caution



- Do not point the camera toward an intense light source, such as the sun or an intense artificial light source. Doing so may damage the image sensor or the camera's internal components.
- In < AF > focus mode, the camera will not shoot unless subjects are in focus. Consider setting the mode to manual focus and focusing manually before shooting.
- If the shooting time is long, using the household power outlet accessories (sold separately) is recommended.
- Shooting long exposures or using shutter speeds longer than the shooting interval will prevent shooting at the specified interval. For this reason, fewer shots than specified will be taken. Using shutter speeds nearly the same as the shooting interval may also reduce the number of shots.
- If the time it takes to record to the card exceeds the shooting interval due to the shooting functions set or card performance, some of the shots may not be taken with the set intervals.
- When using flash with interval timer shooting, set an interval longer than the flash charge time. Intervals that are too short may prevent the flash from firing.
- Intervals that are too short may prevent shooting or autofocus.
- Interval timer shooting is canceled and reset to **[Disable]** if you set the power switch to < OFF >, switch the shooting mode to **[BULB]**, **[C1]**, **[C2]**, or **[C3]**, switch to movie recording, or use EOS Utility (EOS software).
- During interval timer shooting, you cannot use [Remote Control Shooting](#) or remote-release shooting with a Speedlite.

Disables shutter release sounds, operating sounds, and firing and illumination of the flash and other light sources.

The following settings are used and cannot be changed.

- Shutter mode: [Electronic 
- Shutter release sound, focused beep: only headphone output
- Touch sounds, self-timer sounds: silent
- Shutter at shutdown: open
- Long exposure noise reduction: [Disable]
- Flash firing: [Disable]
- AF-assist beam firing: [Disable]
- Self-timer/remote control lamp: not illuminated



When using lenses equipped with focus preset, consider turning off the focus preset beep.

1. Select [: Silent shutter function] ().

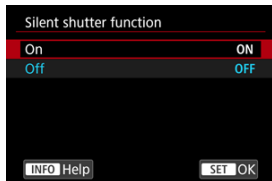
2. Select [On].



You can choose the method of shutter release.

1. Select [: Shutter mode] ().

2. Select an option.

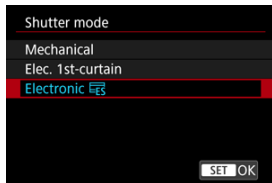

● **Mechanical**

Shooting activates the mechanical shutter. Recommended when shooting with the aperture of a bright lens wide open.

● **Elec. 1st-curtain**



Camera vibration blur may be reduced more than with the mechanical shutter, under some shooting conditions.
Flash sync speed can be set higher than with the mechanical shutter.

● **Electronic **

Enables reduced sound and vibration from shutter operations, compared to mechanical shutter or electronic first-curtain. Recommended when shooting with the aperture of a bright lens wide open.
Maximum shutter speed can be set higher than for mechanical shutter or electronic first-curtain.

- A white frame blinks on the screen when you press the shutter button completely.
- Shutter operations are accompanied by beeps. You can disable beeping in [: **Beep**].

Caution

- With the camera set to **[Elec. 1st-curtain]**, defocused image areas may be incomplete when you shoot near maximum aperture at high shutter speeds under some shooting conditions. If you dislike the appearance of defocused image areas, shooting as follows may give better results.
 - Shoot with an option other than **[Elec. 1st-curtain]**.
 - Lower the shutter speed.
 - Increase the aperture value.
- Setting **[: Silent shutter function]** to **[On]** sets the shutter mode to **[Electronic ]**.
- Zooming during continuous shooting may cause changes in exposure even at the same f/number. For details, refer to the Canon website ([🌐](#)).
- Depending on the lens used, consider shooting with **[Elec. 1st-curtain]** or **[Electronic ]** to ensure effective image stabilization. For details, refer to the lens instruction manual.

Precautions when set to **[Electronic]**

- The continuous shooting speed may become slower depending on the shooting conditions.
- Images may lack suitable exposure if the aperture value changes in **[P]** (Program AE), **[Tv]** (Shutter-priority AE), or **[Fv]** (Flexible-priority AE) mode.
- With some lenses and under some shooting conditions, lens focusing and aperture adjustment may be audible.
- Bands of light may be displayed and captured images may be affected by light and dark banding if you shoot with electronic shutter during flash firing by other cameras or under fluorescent lighting or other flickering light sources.
- Banding may appear in the viewfinder or on the screen if you shoot under flickering light sources.

Enabling Shutter Release Without a Card

Set to **[Disable]** to avoid shooting unless there are cards in the camera.

1. Select **[📷: Release shutter without card]** (🔗).
2. Select **[Disable]**.

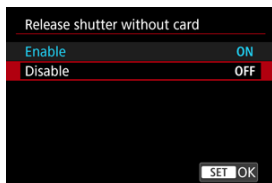

Image Stabilizer (IS Mode)

[Focal Length](#)

This menu is displayed for configuration of camera IS mode settings when you are using a non-IS lens. With IS-equipped lenses, setting the lens Image Stabilizer switch to < ON > combines stabilization by the lens and camera.

1. Select : IS (Image Stabilizer) mode) .

2. Select [IS mode].

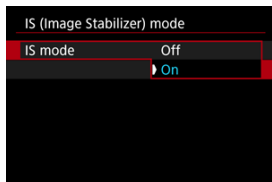

- Select [On] to use IS mode on the camera.

3. Select [Still photo IS].

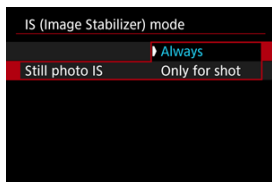

- [Always]: Provides constant image stabilization.
- [Only for shot]: Image stabilization is active only at the moment of shooting.

Caution

- In some cases, this may not provide sufficient stabilization for certain lenses.

Note

- For details on image stabilization for movie recording, see [Movie Digital IS](#).

Focal Length

Image stabilization based on your specified lens focal length is possible by setting the focal length when using lenses that do not support lens communication.

1. Select [Focal length].

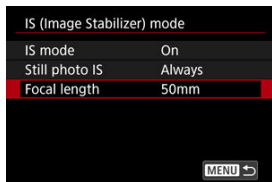

2. Set the focal length.

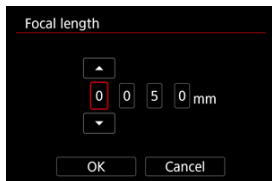

- Turn the $\langle \odot \rangle$ dial to select the digit of the focal length.
- Press $\langle \text{SET} \rangle$ to display $\langle \updownarrow \rangle$.
- Set the desired number, then press $\langle \text{SET} \rangle$. (Returns to $\langle \square \rangle$.)

3. Select [OK].

Caution

- Set [: **Release shutter w/o lens**] to **[Enable]**. **[Disable]** prevents image stabilization.
- **[Focal length]** is not displayed when lenses are attached that support lens communication.

Note

- Focal length can be set in a range of 1–1000 mm (in 1 mm increments).

Quick Control items and the layout are customizable.

1. Select [: Customize Quick Controls] ().

2. Select [Edit layout].

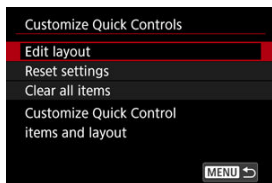

3. Select items to remove.



- Turn the < > dial or use < > to select an item to remove, then press < >.
- Items shown on the Quick Control screen are labeled with a checkmark. Items without a checkmark will be removed.

4. Select items to add.



- Turn the \odot dial or use \ast to select an item to add, then press $\langle \text{SET} \rangle$.
- To change the layout, press the $\langle \text{INFO} \rangle$ button.

5. Change the layout.



- Use the \odot dial to select an item to move, then press $\langle \text{SET} \rangle$.

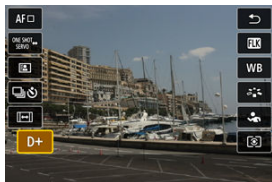

- Use the \odot dial to move the item, then press $\langle \text{SET} \rangle$.
- Press the $\langle \text{MENU} \rangle$ button to exit setup.

6. Select [Save and exit].

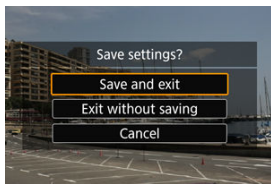

7. Review the screen.



- Press the < **Q** > button to check the screen with your settings applied.

Resetting the Custom Quick Control Screen or Clearing All Items

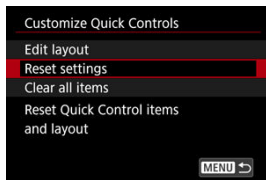

- Select [**Reset settings**] to restore the default Quick Control screen items and layout.
- Select [**Clear all items**] to remove all items from the layout, so that no Quick Control screen is displayed when the < **Q** > button is pressed.

Shooting with the Touch Shutter

Just by tapping the screen, you can focus and take the picture automatically.

1. Enable the Touch Shutter.



- Tap [OFF] in the lower left of the screen.
- Each time you tap the icon, it will toggle between [OFF] and [ON].
- [ON] (Touch Shutter: Enable)
The camera will focus on the spot you tap, then the picture will be taken.
- [OFF] (Touch Shutter: Disable)
You can tap a spot to perform focusing on the spot. Press the shutter button completely to take the picture.

2. Tap the screen to shoot.



- Tap the face or subject on the screen.
- On the point you tap, the camera focuses (Touch AF) using your specified [AF Area](#).
- When [AF-ON] is set, the AF point turns green when focus is achieved, then the picture is taken automatically.
- If focus is not achieved, the AF point turns orange and the picture cannot be taken. Tap the face or subject on the screen again.

Caution

- The camera shoots in single shooting mode regardless of the drive mode setting ([], [], or []).
- Tapping the screen focuses with [One-Shot AF], even if [AF: AF operation] is set to [Servo AF].
- Tapping the screen in magnified view will not focus or take the picture.
- When shooting by tapping with [Review duration] in [: Image review] set to [Hold], you can take the next shot by pressing the shutter button halfway or tapping [].

Note

- To shoot with bulb exposure, tap the screen twice. Tap once to start exposure and again to stop it. Be careful not to shake the camera when tapping the screen.

Image Review

[Review Duration](#)

[Viewfinder Display](#)

Review Duration

To keep the image displayed immediately after you shoot, set to **[Hold]**, and if you prefer not to have the image displayed, set to **[Off]**.

1. Select **[📷: Image review]** (☑).
2. Select **[Review duration]**.

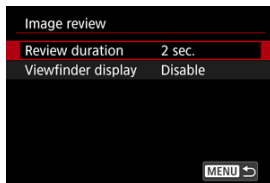

3. Set a time option.

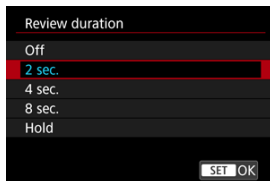



Note

- When **[Hold]** is set, images are displayed as long as the time set in the **[Screen off]** option of **[🔋: Power saving]**.

Viewfinder Display

Set to **[Enable]** for viewfinder display of your shots immediately after you shoot.

1. Select **[📷: Image review]** (🔗).
2. Select **[Viewfinder display]**.

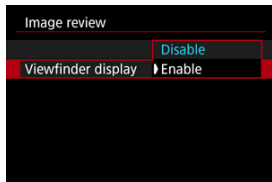

- Select an option.



Note

- **[Viewfinder display]** settings take effect when **[Image review]** is set to an option other than **[Off]**.

High-speed display that switches between each shot and the live image is available when shooting in [H] (high-speed continuous shooting) drive mode and in a shutter mode other than electronic shutter.

1. Select [H: High speed display] (H).
2. Select an option.

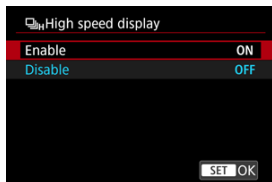

- Select [Enable] for display that switches between each shot and the live image.

Caution

- Images may waver or flicker during high-speed display. This occurs more often at high shutter speeds. However, this does not affect shooting results.
- High-speed display is not performed for shutter speeds slower than 1/30 sec., aperture values higher than f/11, conditions that make autofocusing difficult, flash photography, or ISO expansion. It may also stop as you are shooting.
- High-speed display is not available in the following cases.
 - With [OVF sim. view assist] set to [On]
 - With [Display simulation] set to [Disable] or [Exposure only during DOF]



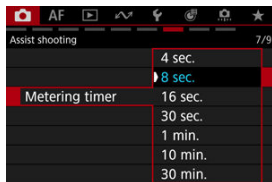

You can set how long the metering timer runs (which determines the duration of exposure value display/AE lock) after it is triggered by an action such as pressing the shutter button halfway.

1. Select [📷: Metering timer] (🔗).
2. Set a time option.



 [View Assist Display Conditions](#)



 [View Assist Display Settings](#)

The appearance of images in HDR shooting () with [: HDR shooting (PQ)] or in shooting with custom pictures () applied, as shown on the camera screen, viewfinder, or non-HDR display devices connected via HDMI, can be made to resemble the appearance on HDR display devices.

Caution

- Recorded movies will look different from how they appear on the screen.

View Assist Display Conditions

- [: HDR shooting (PQ)] is set to [HDR PQ]
- [Gamma/Color Space] in [: Custom Picture] is set as follows
 - Canon Log 2 / C.Gamut
 - Canon Log 3 / C.Gamut
 - PQ / BT.2020
 - HLG / BT.2020

*HLG stands for Hybrid Log-Gamma.
- The following gamma/color space is selected in [Registering look files](#), before setting [Look File] to [On]
 - HDR PQ(BT.2100)
 - HDR HLG(BT.2100)

View Assist Display Settings

1. Select [📷: 📷📺 HDR/C.Log View Assist.] (🔍, 🔍).
2. Select screen or viewfinder display.

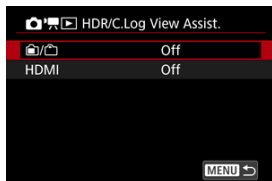

- 📷/📺
Use View Assist display on the screen [📺] and viewfinder [📷].
- **HDMI**
Use view-assisted display on non-HDR display devices connected via HDMI.

3. Select an option.

Screen and viewfinder

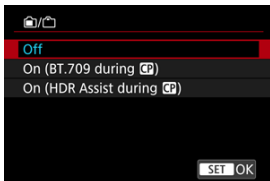

- **On (BT.709 during CP)**

When the camera is set to **[HDR PQ]**, converted images are displayed that resemble how the images would look on an HDR display device. Image display with a custom picture applied involves basic conversion to a standard gamma/color space.

- **On (HDR Assist during CP)**

When the camera is set to **[HDR PQ]**, converted images are displayed that resemble how the images would look on an HDR display device. Image display with a custom picture applied involves conversion so that subjects with intermediate brightness resemble how they would appear on an HDR display device.

[HDMI]

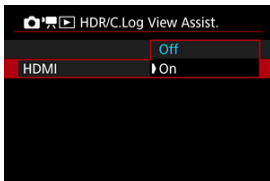

- Select **[On]**.

⚠ Caution

- Optical viewfinder simulation is used for display when **[📷: OVF sim. view assist]** is set to **[On]**.



Note

- [View Assist] is shown on the information display screen during movie recording with View Assist.
- View Assist is also used with magnified view.
- View Assist display settings do not affect the images captured.

With display simulation, display of image brightness and depth of field more closely matches the actual brightness (exposure) of your shots.

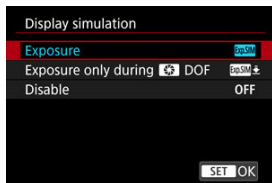

1. Select [📷: Display simulation] (🔗).
2. Select an option.



- **Exposure+DOF (📷SIM)**
Image brightness and depth of field as displayed closely matches the actual brightness (exposure) of your shots. If you set exposure compensation, the image brightness will change accordingly. Similarly, changes to the aperture value will alter the depth of field.
- **Exposure (Exp.SIM)**
Image brightness as displayed closely matches the actual brightness (exposure) of your shots. If you set exposure compensation, the image brightness will change accordingly.
- **Exposure only during [📷] DOF (Exp.SIM ↓)**
Normally, the image is displayed at standard brightness, so it is easy to see. Only when you press and hold the depth-of-field preview button will image brightness resemble actual brightness (exposure) of your shot, and you can check depth of field.
- **Disable (OFF)**
The image is displayed at standard brightness, so it is easy to see. Even if you set exposure compensation, the image is displayed at the standard brightness.

 Caution

Notes on [Exposure+DOF]

- Display may flicker at some shutter speeds.
- With EF lenses, this setting may increase the shutter-release time lag.
- The depth of field shown is only a guideline. For more precise indication of the depth of field, press the depth-of-field preview button.
- [Exposure+DOF] is not available with some lenses.
-  blinks if either exposure or depth of field cannot be simulated, or if neither can be simulated.
-  is dimmed if either exposure or depth of field simulation stops, or if both simulations stop.
- Zooming with certain lenses may change the exposure. For details, refer to the Canon website ().
- Depth-of-field previewing is canceled when you press the shutter button halfway.

Natural-looking viewfinder and screen display, resembling the view from an optical viewfinder, is available in still photo shooting. Note that images displayed with this feature set to **[On]** may differ from actual shooting results.

1. Select **[📷: OVF sim. view assist] (🔗)**.
2. Select an option.

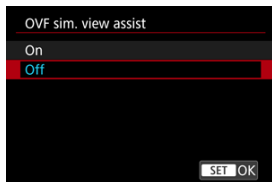

⚠ Caution

- Setting this feature to **[On]** sets **[📷: Display simulation]** to **[Disable]**.
- Optical viewfinder simulation is used for display when this feature is set to **[On]** in HDR shooting.
- Optical viewfinder simulation is not used during display to external monitors, including in display to both an external monitor and the camera screen.
- Depending on setting screens, optical viewfinder simulation may not be used for display.
- Display may not resemble an optical viewfinder in some cases.
- Display appearance may change during continuous shooting, with some combinations of drive and shutter modes.

📄 Note

- Not available when the camera is set to shoot multiple exposures.

This display option makes it easier to shoot fast-moving subjects by eliminating the momentary initial lack of viewfinder images (blackout) in continuous shooting.

1. Select [📷:  Blackout-free display] (🔗).
2. Select [On].

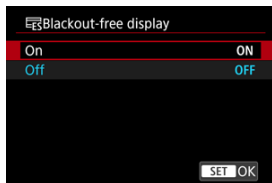

⚠ Caution

- Display may not be smooth in these cases.
 - In flash photography
 - In magnified view
 - Under low light
 - With [Multiple exposure] in [📷: Multiple exposure] set to an option other than [Disable]
- The screen may flicker during aperture adjustment.
- The shutter-release time lag may vary.
- Has no effect when the following functions are in use.
 - Bulb timer
 - Long exposures (1 sec. or more)
 - Long exposure noise reduction
 - Multiple-exposure shooting ([BUSY] appears when you shoot the last exposure in a set)
 - Focus bracketing
- Setting this feature to [On] locks [📷: Display simulation] to [Exposure+DOF] and [📷: OVF sim. view assist] to [Off].
- Blackout stills occur in flash photography or with [📷: Anti-flicker shoot.] set to [Enable].

Shooting Information Display

- [Customizing Information on the Screen](#)
- [Customizing Information in the Viewfinder](#)
- [Viewfinder Vertical Display](#)
- [Grid](#)
- [Histogram](#)
- [Electronic Level Size](#)
- [Card Free Space \(%\) Display](#)
- [Lens Information Display](#)
- [Vertical Exposure Level Indicator](#)
- [Clearing Settings](#)

You can customize the details and screens of information shown on the screen or in the viewfinder when you shoot.

1. Select [: Shooting info. disp.] ().
2. Select [Screen info. settings].

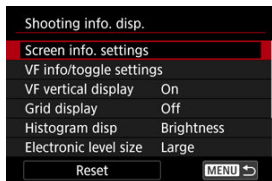

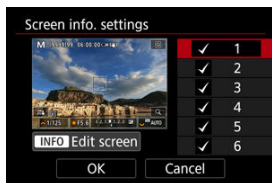

3. Select screens.

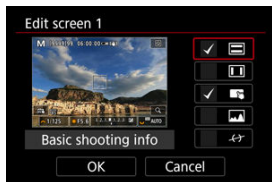

- Turn the dial to select screens of information to show on the camera.
- For information you prefer not to display, press to clear the checkmark [].
- To edit the screen, press the button.

4. Edit the screen.



- Turn the <  > dial to select options to show on the screen of information.
- For items you prefer not to display, press <  > to clear the checkmark [✓].
- Select [OK] to register the setting.

1. Select [: Shooting info. disp.] ().
2. Select [VF info/toggle settings].

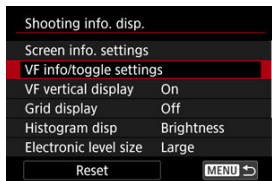



3. Select screens.

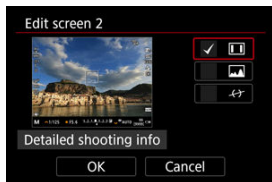

- Turn the < > dial to select information screens to show in the viewfinder.
- For information you prefer not to display, press < > to clear the checkmark [✓].
- To edit the screen, press the < INFO > button.

4. Edit the screen.



- Turn the <  > dial to select options to show in the viewfinder.
- For items you prefer not to display, press <  > to clear the checkmark [✓].
- Select [OK] to register the setting.

Viewfinder Vertical Display

You can select how viewfinder information is displayed when you are shooting still photos vertically.

1. Select [: Shooting info. disp.] ().

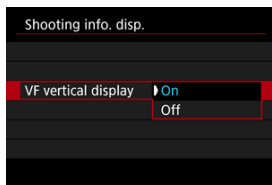

2. Select [VF vertical display].



- **On**
Information is automatically rotated, making it easier to read.
- **Off**
Information is not automatically rotated.

Grid

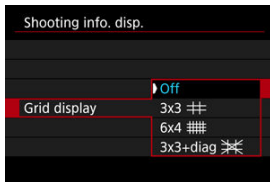

A grid can be displayed on the screen and viewfinder.

1. Select [: Shooting info. disp.] ().
2. Select [Grid display].



Histogram

You can select the content and display size of the histogram.

1. Select [: Shooting info. disp.] ().
2. Select [Histogram disp].

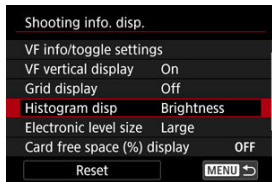

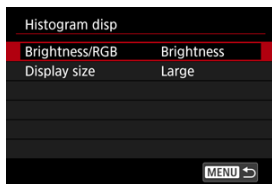

3. Select an option.



- Select the content ([**Brightness**] or [**RGB**]) and display size ([**Large**] or [**Small**]).

Electronic Level Size

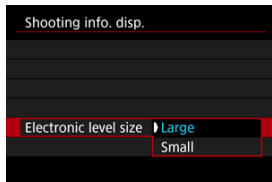

You can select the display size of the electronic level.

1. Select [: Shooting info. disp.] ().
2. Select [Electronic level size].



Card Free Space (%) Display

You can display card free space on the screen.

1. Select [: Shooting info. disp.] ().
2. Select [Card free space (%) display].

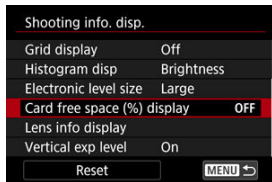

3. Select [On].

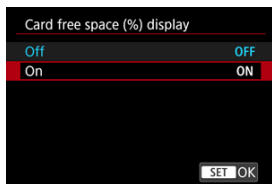



Note

- During still photo shooting or when writing to cards, the number of available shots is shown instead of the free space.

Lens Information Display

You can display information about the lens in use.

1. Select [: Shooting info. disp.] ().
2. Select [Lens info display].

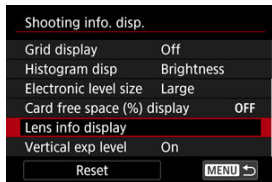

3. Select an option.

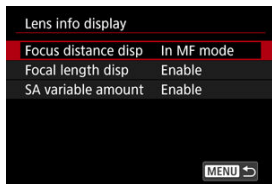

- **Focus distance disp**
You can display focus distance when using RF or RF-S lenses. In focus distance display, you can select the timing and unit of measurement.
- **Focal length disp**
You can display the focal length of the lens in use.
- **SA variable amount**
You can display the amount of correction set when using lenses featuring spherical aberration control.
* SA: spherical aberration

Vertical Exposure Level Indicator

You can show or hide the vertical exposure level indicator displayed on the right side of the screen.

1. Select [: Shooting info. disp.] (ⓧ).

2. Select [Vertical exp level].

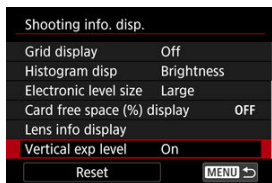

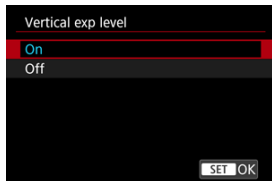

3. Select an option.



- When set to [**On**], the metering value is shown in real time on the vertical exposure level indicator in all shooting modes except [**BULB**].
- Set to [**Off**] if you prefer not to display the indicator.

Note

- The vertical exposure level indicator is shown while the metering timer is active.

1. Select [: Shooting info. disp.] ().
2. Select [Reset].

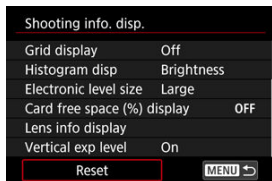

3. Select [OK].

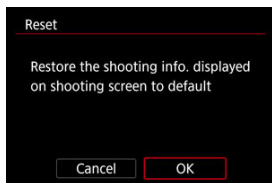

Reverse Display

A mirror image can be displayed when you shoot with the screen rotated toward the subject (toward the front of the camera).

1. Select [📷: Reverse display] (🔗, 🔗).
2. Select an option.

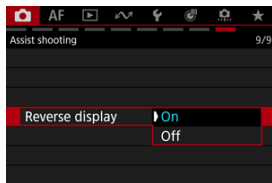

- Select [Off] if you prefer not to reverse display when the screen is facing the subject.

Display Frame Rate

You can set the display frame rate for the shooting screen in still photo shooting. Choose whether to conserve battery power or use a high frame rate for display.

1. Select [📷: 📷/📷 Display frame rate set.] (🔗).
2. Select an option.

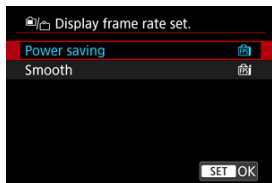

When set to [Smooth]

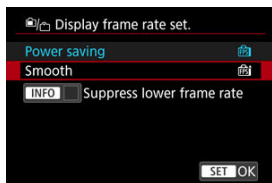

- By pressing the < INFO > button to add a checkmark, you can include low-light locations in the scenarios for suppressing lower display frame rates.

 **Caution**

- Shooting under low light with [**Suppress lower frame rate**] set for shooting screen display may affect performance as follows.
 - Faster battery consumption
 - Fewer shots available
 - Lower image display brightness
 - Difficulty in autofocusing
 - Lower metering precision
 - Lower flicker detection precision
 - Lower subject detection precision

Viewfinder Display Format

You can select how information is presented in the viewfinder.

1. Select [📷: VF display format] (🔍, 🔍).
2. Select an option.

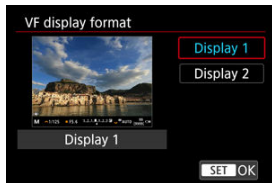

Auto Power Off Temperature

You can set the maximum camera body temperature at which the camera automatically turns off. Setting this level higher than the standard temperature can extend the available shooting time by removing some operating restrictions.

1. Select [📷: Auto pwr off temp.] (🔍, 📷).

2. Select [High].

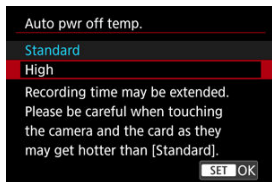

- [High] sets the maximum temperature higher than the standard setting.

3. Select [OK].

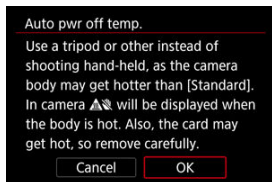

 Caution

- The camera and memory cards may become hotter when [: **Auto pwr off temp.**] is set to [**High**].
 - We recommend using a tripod or the like to avoid handheld shooting, which may cause problems such as low-temperature contact burns.
 - Do not touch CFexpress cards immediately after shooting. Cards may be hot, which may cause burns. Wait until the card has cooled down before removing it.

You can select how the camera determines subject brightness. In [A+] mode, evaluative metering is set automatically.

Setting from the Quick Control screen

1. Press the <Q> button (10).

- With an image displayed on the screen, press the <Q> button.

2. Select the metering mode.

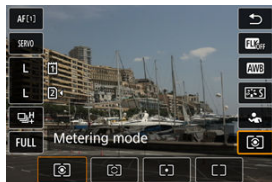

- To select an item, turn the <10> dial or press <10> up or down.
- To select the metering mode, turn the <10> or <10> dial, or press <10> left or right.

Setting from the menu

1. Select [CAMERA: Metering mode] (✓).
2. Select the metering mode.

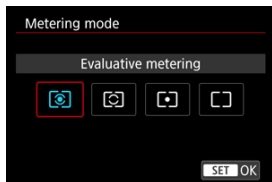

Evaluative metering

General-purpose metering mode suited even for backlit subjects. The camera adjusts the exposure automatically to suit the scene.

Partial metering

Effective where there are much brighter lights around the subject due to backlight, etc.





Spot metering

Effective when metering a specific part of the subject. The spot metering area is indicated on the screen.

☐ Center-weighted average

The metering across the screen is averaged, with the center of the screen weighted more heavily.

Note

- By default, the camera will set the exposure as follows.
With , holding down the shutter button halfway locks the exposure value (AE lock) after the camera focuses with One-Shot AF. With /, the exposure value is set at the moment the picture is taken (without locking the exposure value when the shutter button is pressed halfway).
- With : **AE lock meter. mode after focus** () , you can set whether or not to lock the exposure (AE lock) once subjects are in focus with One-Shot AF.

Performs metering for subjects detected based on the [**AF: Subject to detect**] setting.

1. Select [**☑: Detect priority AE while AF**] (🔗, 🔗).
2. Select an option.

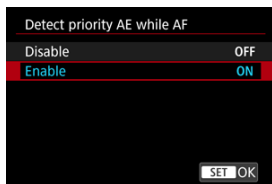

- [**Enable**]: Metering is based on the AF point or AF area where the subject was detected.
- [**Disable**]: Metering is based on the entire screen.

⚠ Caution

- In still photo shooting, [**Enable**] is available only with [**☑: Metering mode**] set to [**Evaluative metering**].
- Has no effect during manual focusing (MF).

📄 Note

- Metering is also based on the entire screen when [**AF: Subject to detect**] is set to [**None**].

Exposure compensation can brighten (increased exposure) or darken (decreased exposure) the standard exposure set by the camera.

Exposure compensation can be set in [Fv], [P], [Tv], [Av], and [M] shooting modes.

For details on exposure compensation when [M] mode and ISO Auto are both set, see [M: Manual Exposure](#), and for details on [Fv] mode, see [Fv: Flexible-Priority AE](#).

1. Check the exposure.

- Press the shutter button halfway and check the exposure level indicator.

2. Set the compensation amount.

Increased exposure, to brighten images



Decreased exposure, to darken images



- Set it by looking at the screen as you turn the < > dial.
- A [] icon is displayed to indicate exposure compensation.

3. Take the picture.

- To cancel exposure compensation, set the exposure level [] to the standard exposure index ([]).

Caution

- If [Auto Lighting Optimizer] () is set to any setting other than [Disable], the image may still look bright even if decreased exposure compensation is set to darken images.



Note

- The exposure compensation amount will remain in effect even after you set the power switch to <OFF>.

[Effect of AE Lock](#)

To keep shooting at the same exposure, such as when you will set the focus and exposure separately, you can press the < * > button for AE lock. It is effective for shooting backlit subjects, etc.

1. Focus on the subject.

- Press the shutter button halfway.
- The exposure value will be displayed.

2. Press the < * > button (ⓘ8).

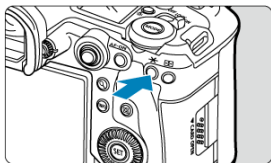

- A [*] icon is displayed in the lower left of the screen to indicate that exposure is locked (AE lock).
- Each time you press the < * > button, the current exposure setting is locked.

3. Recompose and take the picture.



- When you are to take more pictures while maintaining the AE lock, keep holding down the < * > button and press the shutter button to take another picture.

Note

- AE lock is not possible with bulb exposures.

Effect of AE Lock

Metering Mode Selection	AF Point Selection	
	Automatic Selection	Manual Selection
	Exposure centered on the AF point in focus is locked.	Exposure centered on the selected AF point is locked.
	Center-weighted exposure is locked.	

* When is set with the lens's focus mode switch set to < MF >, center-weighted exposure is locked.

General Still Photo Shooting



 [Information Display](#)

 [General Still Photo Shooting Precautions](#)

Information Display

For details on the icons displayed for still photo shooting, see [Information Display](#).

Note

- White display of the **[Exp.SIM]** icon indicates that your shots will be about as bright as the image displayed.
- If the **[Exp.SIM]** icon is blinking, it indicates that the image is displayed at a brightness that differs from the actual shooting result because of low- or bright-light conditions. However, the actual image recorded will reflect the exposure setting. Note that the noise may be more noticeable than the actual image recorded.
- Display simulation may not be performed under some shooting settings. The **[Exp.SIM]** icon and histogram will be displayed in gray. The image will be displayed on the screen at the standard brightness. The histogram may not be properly displayed in low- or bright-light conditions.
- No histogram is displayed when **[CAMERA: Display simulation]** () is set to **[Disable]** or **[Exposure only during]**  **DOF**.

General Still Photo Shooting Precautions

! Caution

- Do not point the camera toward an intense light source, such as the sun or an intense artificial light source. Doing so may damage the image sensor or the camera's internal components.

Image quality

- When you shoot at high ISO speeds, noise (such as dots of light and banding) may become noticeable.
- Shooting in high temperatures may cause noise and irregular colors in the image.
- Frequent shooting over an extended period may cause high internal temperatures and affect image quality. When you are not shooting, always turn off the camera.
- If you shoot a long exposure while the camera's internal temperature is high, image quality may decline. Stop shooting and wait a few minutes before shooting again.

White [🔥] and red [🔥] internal temperature warning icons

- White [🔥] or red [🔥] icons indicate high internal camera temperature, caused by factors such as extended shooting or use in hot environments.
- The white [🔥] icon indicates that the image quality of still photos will decline. Stop shooting for a while and allow the camera to cool down.
- Shooting at low ISO speeds instead of high speeds is recommended when the white [🔥] icon is displayed.
- The red [🔥] icon indicates that shooting will soon be terminated automatically. Shooting will not be possible again until the camera cools down internally, so stop shooting temporarily or turn off the camera and let it cool down a while.
- Shooting in hot environments over extended periods will cause the white [🔥] or red [🔥] icon to appear sooner. When you are not shooting, always turn off the camera.
- If the camera's internal temperature is high, the quality of images shot with a high ISO speed or long exposure may decline even before the white [🔥] icon is displayed.

Shooting results

- In magnified view, the shutter speed and aperture value will be displayed in orange. If you take the picture in magnified view, the exposure may not come out as desired. Return to the normal view before taking the picture.
- Even if you take the picture in magnified view, the image will be captured with the image area of the normal view.

Images and display





- Under low- or bright-light conditions, the displayed image may not reflect the brightness of the captured image.
- Although noise may be noticeable in images under low light (even at low ISO speeds), there will be less noise in your shots, due to differences in image quality between displayed and captured images.
- The screen may flicker if the light source (lighting) changes. In this case, stop shooting temporarily and resume under the light source you will use.
- Pointing the camera at different direction may momentarily prevent correct display of brightness. Wait until the brightness level stabilizes before shooting.
- If there is a very bright light source in the image, the bright area may appear black on the screen. However, the actual captured image will correctly show the bright area.
- Under low light, bright [: **Screen brightness**] settings may cause noise or irregular colors in images. However, the noise or irregular colors will not be recorded in the captured image.
- When you magnify the image, the image sharpness may look more pronounced than in the actual setting.

Lens

- If the attached lens has an Image Stabilizer and you set the Image Stabilizer switch to < **ON** >, the Image Stabilizer will operate at all times even if you do not press the shutter button halfway. The Image Stabilizer consumes battery power and may decrease the number of available shots depending on the shooting conditions. When the Image Stabilizer is not necessary, such as when using a tripod, it is recommended that you set the Image Stabilizer switch to < **OFF** >.
- With EF lenses, focus preset during shooting is only available when using (super) telephoto lenses equipped with this function released in and after the second half of 2011.



Note

- The field of view is approx. 100% (with image quality set to JPEG []).
- If the camera is idle over an extended period, the screen will turn off automatically after the time set in [**Screen off**] or [**Viewfinder off**] under [: **Power saving**]. The camera then turns off automatically after the time set in [**Auto power off**] ().
- Using a commercially available HDMI cable, you can display images on a television (). Note that no sound will be output.

Movie Recording



To prepare for movie recording, set the still photo shooting/movie recording switch to , then press the <MODE> button and choose a recording mode.

☆ to the right of titles indicates functions only available in [A+], [TV], [AV], or [M] mode.

Caution

- When switching from still photo shooting to movie recording, check the camera settings again before recording movies.

Note

- You can record movies by pressing the movie shooting button during still photo shooting. It may take a moment before recording begins.
- Sizes of movies recorded in [A+] mode correspond to [A+] recording sizes. Sizes of movies recorded in modes other than [A+] correspond to [S/P] recording sizes.

- [Tab Menus: Movie Recording](#)
- [Movie Recording](#)
- [Movie Recording Size](#)
- [High Frame Rate](#)
- [Main Recording Format](#)
- [Movie Cropping](#)☆

- [Dual Shooting \(Still Photos and Movies\)](#)☆
- [Sound Recording](#)
- [Audio Format](#)
- [Audio Settings](#)
- [Audio Status](#)
- [Custom Pictures](#)☆
- [HDR Movie Mode](#)☆
- [Time-Lapse Movies](#)
- [Movie Self-Timer](#)
- [Tally Lamp](#)☆
- [Pre-Recording Setting](#)☆
- [Image Stabilizer \(IS Mode\)](#)
- [Movie Auto Level](#)
- [False Color Settings](#)☆
- [Zebra Settings](#)☆
- [Shooting Information Display](#)☆
- [Quick Control Screen](#)☆
- [Standby: Low Resolution](#)☆
- [Canon Log HDMI Output Range](#)☆
- [Metadata](#)☆
- [Time Code](#)
- [Other Menu Functions](#)
- [General Movie Recording Precautions](#)

Tab Menus: Movie Recording

● Image quality/size

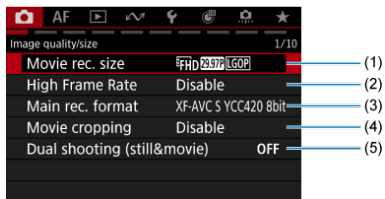

- (1) [Movie rec. size](#)
- (2) [High Frame Rate](#)
- (3) [Main rec. format](#)
- (4) [Movie cropping](#) ☆
- (5) [Dual shooting \(still&movie\)](#) ☆

● Sound-rec. settings

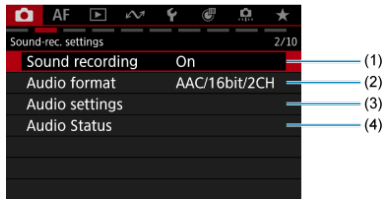

- (1) [Sound recording](#)
- (2) [Audio format](#)
- (3) [Audio settings](#)
- (4) [Audio Status](#)

● Exposure

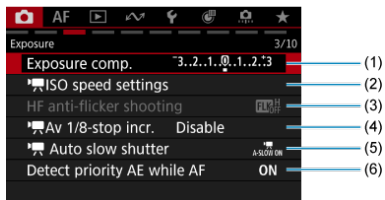

- (1) [Exposure comp.](#) ☆
- (2) [ISO speed settings](#) ☆
- (3) [HF anti-flicker shooting](#) ☆
- (4) [Av 1/8-stop incr.](#) ☆
- (5) [Auto slow shutter](#) ☆
- (6) [Detect priority AE while AF](#) ☆

● Color/tone/Dynamic range

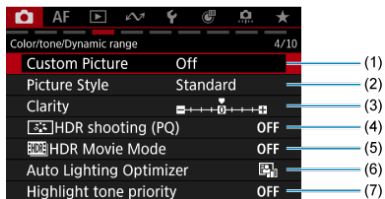

- (1) [Custom Picture](#)
- (2) [Picture Style](#)
 - [Picture Style Selection](#) ☆
 - [Picture Style Customization](#) ☆
 - [Picture Style Registration](#) ☆
- (3) [Clarity](#) ☆
- (4) [HDR shooting \(PQ\)](#) ☆
- (5) [HDR Movie Mode](#) ☆
- (6) [Auto Lighting Optimizer](#) ☆
- (7) [Highlight tone priority](#) ☆

● White balance/Quality correction

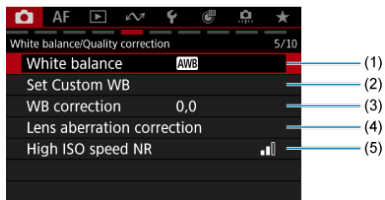

- (1) [White balance](#) ☆
- (2) [Set Custom WB](#) ☆
- (3) [WB correction](#) ☆
- (4) [Lens aberration correction](#) ☆
- (5) [High ISO speed NR](#) ☆

● Various shooting

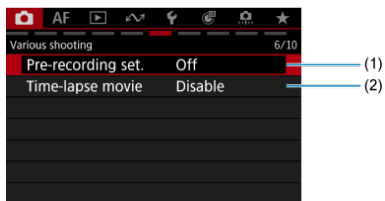

- (1) [Pre-recording set.](#) ☆
- (2) [Time-lapse movie](#)

● Shutter control/Assist shooting



- (1) [Movie self-timer](#)
- (2) [Tally lamp](#) ☆
- (3) [IS \(Image Stabilizer\) mode](#)
- (4) [Auto level](#)
- (5) [Customize Quick Controls](#) ☆
- (6) [Metering timer](#) ☆

● Assist shooting

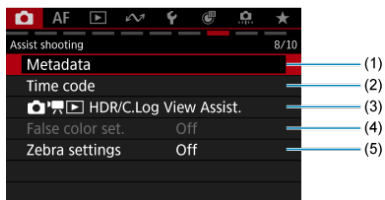

- (1) [Metadata](#) ☆
- (2) [Time code](#)
- (3) [HDR/C.Log View Assist.](#) ☆
- (4) [False color set.](#) ☆
- (5) [Zebra settings](#) ☆

● Assist shooting

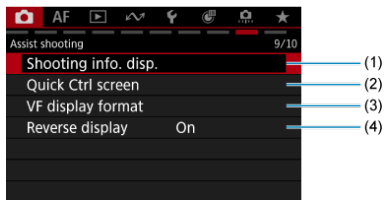

- (1) [Shooting info. disp.](#) ☆
- (2) [Quick Ctrl screen](#) ☆
- (3) [VF display format](#)
- (4) [Reverse display](#)

● Assist shooting/HDMI

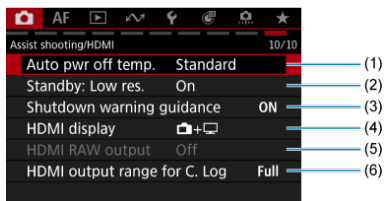



- (1) [Auto pwr off temp.](#)
- (2) [Standby: Low res.](#) ☆
- (3) [Shutdown warning guidance](#)
- (4) [HDMI display](#)
- (5) [HDMI RAW output](#) ☆
- (6) [HDMI output range for C. Log](#) ☆

Movie Recording



-  [Autoexposure Recording](#)
-  [Shutter-Priority AE](#)
-  [Aperture-Priority AE](#)
- [Scene Icons](#)
- [ISO Speed in \[!\[\]\(18570b67a4686b081406cd3de636c1c3_img.jpg\)\]\[!\[\]\(411af059a517db12f1097bc63c4fbe36_img.jpg\)\]\[!\[\]\(ed2b7fb1e3bd6514676d2ab3c70d5776_img.jpg\)\]\[!\[\]\(63f22f364560f085b88206f094473649_img.jpg\)\]\[!\[\]\(1167d0d640d4660b041f4c30896eb62c_img.jpg\)\] Mode](#)
-  [Manual Exposure Recording](#)
- [ISO Speed in \[!\[\]\(5fb1f24875e954b62806996a167f04fe_img.jpg\)\] Mode](#)
- [Shutter Speed](#)
- [Still Photo Shooting](#)
- [Information Display \(Movie Recording\)](#)

Autoexposure Recording

Exposure is controlled automatically to suit the brightness.

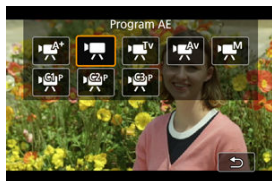
1. Set the recording mode to [] or [].



- Press the <MODE> button, then turn the < > dial to select [] or [].

2. Focus on the subject.

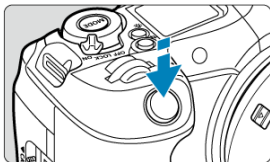

- Before recording a movie, focus with AF (☑) or manual focus (☑).
- The camera focuses continuously under default settings, with **[Movie Servo AF]** in **[AF: Movie Servo AF]** set to **[Enable]** (☑).
- By default, pressing the < AF-ON > button focuses using your specified AF area.
- By default, pressing the shutter button halfway starts metering.

3. Record the movie.

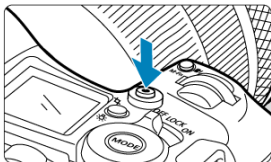

- Press the movie shooting button to start recording a movie. You can also start recording a movie by tapping [●] on the screen.



- While the movie is being recorded, [●REC] (1) is displayed, the screen is outlined in red, and the tally lamp is lit.

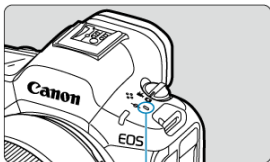



(2)

- Sound is recorded by the microphone (2).
- To stop recording the movie, press the movie shooting button again. You can also stop recording a movie by tapping [■] on the screen.

[] recording mode enables you to set your preferred shutter speed for movies. ISO speed and aperture values are set automatically to suit the brightness and obtain standard exposure.

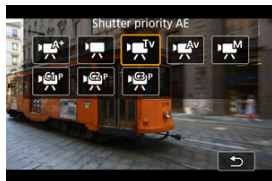
1. Set the recording mode to [].



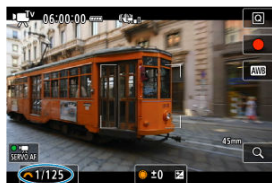

- Press the < MODE > button, then turn the <  > dial to select [].

2. Set the shutter speed (1).



(1)

- Set it by looking at the screen as you turn the <  > dial.
- Available shutter speeds vary by frame rate ().

3. Focus and record the movie.

- Same as steps 2 and 3 for  [Autoexposure Recording](#).



 **Caution**

- Avoid adjusting shutter speed while recording movies, which will record changes in exposure.
- When recording a movie of a moving subject, a shutter speed of approx. 1/25 sec. to 1/125 sec. is recommended. The faster the shutter speed, the less smooth the subject's movement will look.
- If you change the shutter speed while recording under fluorescent or LED lighting, image flicker may be recorded.

[] recording mode enables you to set your preferred aperture value for movies. ISO speed and shutter speed are set automatically to suit the brightness and obtain standard exposure.

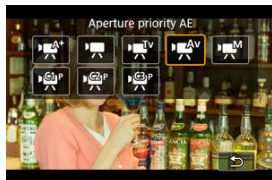
1. Set the recording mode to [].



- Press the <MODE> button, then turn the < > dial to select [].

2. Set the aperture value (1).



(1)

- Set it by looking at the screen as you turn the < > dial.

3. Focus and record the movie.

- Same as steps 2 and 3 for [] / [] [Autoexposure Recording](#).

Caution

- Avoid adjusting the aperture value while recording movies, which will record changes in exposure caused by aperture adjustment.

Note

Notes for [M^A], [P^{Av}], [M^{Tv}], and [M^{Av}] modes

- You can lock the exposure (AE lock) by pressing the < * > button (except in [M^A] mode). After applying AE lock during movie recording, you can cancel it by pressing the < * > button. (AE lock setting is retained until you press the < * > button.)
- Exposure compensation can be set in a range of up to ±3 stops by turning the <  > dial (except in [M^A] mode).
- In [M^A] and [P^{Av}] mode, the ISO speed, shutter speed, and aperture value are not recorded in movie Exif information.
- The camera is compatible with Speedlite functionality to activate the LED light automatically under low light when recording movies in [M^A], [P^{Av}], [M^{Tv}], and [M^{Av}] modes. For details, refer to the Instruction Manual of the EX series Speedlite equipped with an LED light.

Scene Icons



In [A] recording mode, the camera detects the type of scene and sets all settings accordingly. The detected scene type is indicated in the upper left of the screen. For icon details, see [Scene Icons](#).

ISO Speed in [A]/[P]/[Tv]/[Av] Mode



ISO speed is set automatically. See [ISO speed \(recommended exposure index\) in movie recording](#).

Manual Exposure Recording

You can manually set the shutter speed, aperture value, and ISO speed for movie recording.

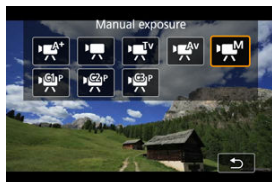



1. Set the recording mode to .

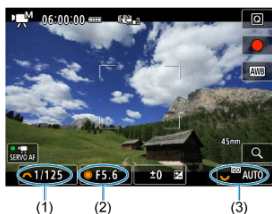
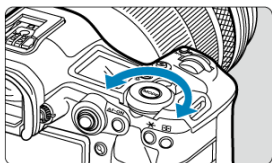
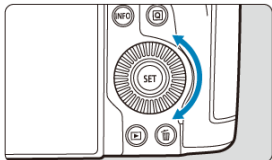
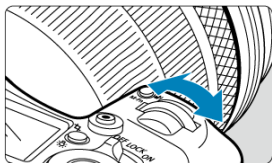

- Press the **<MODE>** button, then turn the  dial to select .

2. Set the shutter speed, aperture value, and ISO speed.



- Press the shutter button halfway and check the exposure level indicator.
- Turn the <  > dial to set the shutter speed (1), the <  > dial to set the aperture value (2), and the <  > dial to set the ISO speed (3).
- Available shutter speeds vary by frame rate ()







3. Focus and record the movie.

- Same as steps 2 and 3 for  [Autoexposure Recording](#).

Caution

- ISO speed cannot be expanded to L (equivalent to ISO 50) in movie recording.
- During movie recording, avoid changing the shutter speed, aperture value, or ISO speed, which may record changes in the exposure or create more noise at high ISO speeds.
- When recording a movie of a moving subject, a shutter speed of approx. 1/25 sec. to 1/125 sec. is recommended. The faster the shutter speed, the less smooth the subject's movement will look.
- If you change the shutter speed while recording under fluorescent or LED lighting, image flicker may be recorded.

Note

- Exposure compensation with ISO Auto can be set in a range of ± 3 stops.
- When ISO Auto is set, you can press the  button to lock the ISO speed. After locking the ISO speed during movie recording, you can cancel it by pressing the  button. (ISO speed lock is maintained until you press the  button.)
- If you press the  button and recompose the shot, you can see the exposure level difference on the exposure level indicator () compared to when the  button was pressed.

ISO Speed in [M] Mode

You can set the ISO speed manually or select **[AUTO]** to set it automatically. For details on ISO speed, see [ISO speed \(recommended exposure index\) in movie recording](#).

Shutter Speed

Available shutter speeds in [i] and [M] mode vary depending on the frame rate of your specified movie recording quality.

Frame Rate	Shutter Speed (Sec.)	
	Normal Movie Recording	High Frame Rate Movie Recording
239.8P	–	1/250–1/8000
119.9P	–	1/125–1/8000
100.0P		1/100–1/8000
59.94P	1/8–1/8000	–
50.00P		
29.97P		
25.00P		
24.00P		
23.98P		



Still Photo Shooting

If you will shoot still photos while recording movies, set up : **Dual shooting (still&movie)**. After this, shoot still photos as you would normally do.

Information Display (Movie Recording)



For details on the icons on the movie recording screen, see [Information Display](#).

Caution

- The remaining time displayed for movie recording is only a guideline.
- Movie recording may stop before the initially displayed recording time elapses if the red  icon appears due to high internal camera temperature during recording ().

Movie Recording Size



- ☑ [8K/4K Movie Recording](#)
- ☑ [Image Area](#)
- ☑ [Frame Rate \(fps: frames per second\)](#)
- ☑ [Compression Method](#)
- ☑ [Cards That Can Record Movies](#)
- ☑ [Movie Files Exceeding 4 GB](#)
- ☑ [Total Movie Recording Time and File Size Per Minute](#)

You can set the resolution, frame rate, and compression method in [: **Movie rec. size**]. Note that the frame rate is updated automatically to match the [: **System frequency**] setting ().

1. Select [: **Movie rec. size**] (.

2. Set the item.



- Turn the  dial to select a tab (1).
- Press  vertically or horizontally to change the setting (2).
- When finished, press .

Available resolutions

Resolution	Image Size	Aspect Ratio	Restrictions
8K-D	8192×4320	Approx. 17:9	<ul style="list-style-type: none"> Available when [Main rec. format] is set to [XF-HEVC S]. 8K recording is not available when [High Frame Rate] or [Movie cropping] is set to [Enable], or with RF-S or EF-S lenses.
8K-U	7680×4320	16:9	
4K-D / 4K-D _{Fine}	4096×2160	Approx. 17:9	<ul style="list-style-type: none"> Fine options have higher image quality and lower compression. Fine recording is not available when [High Frame Rate] or [Movie cropping] is set to [Enable], or with RF-S or EF-S lenses.
4K-U / 4K-U _{Fine}	3840×2160	16:9	
2K-D / 2K-D _{Fine}	2048×1080	Approx. 17:9	
FHD / FHD _{Fine}	1920×1080	16:9	

With [📷: Main rec. format] set to [RAW] (🔗)

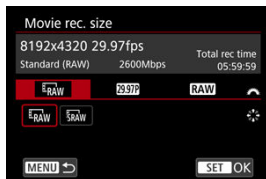

You can set the resolution, frame rate, and type of RAW for RAW movie output. The following combinations of movie recording quality options are available.

System Frequency	Resolution	Image Size	Frame Rate	Type of RAW
54.94 Hz: NTSC	RAW	8192×4320	59.94P	RAW
			29.97P 24.00P 23.98P	RAW RAW
50.00 Hz: PAL			50.00P	RAW
			25.00P 24.00P	RAW RAW
54.94 Hz: NTSC	SRAW	4096×2160	59.94P 29.97P 24.00P	RAW RAW
			23.98P	
50.00 Hz: PAL			50.00P 25.00P 24.00P	

⚠ Caution

- If you change the [📷: System frequency] setting, also set [📷: Movie rec. size] again.
- Other devices may not play movies such as 8K/4K, 59.94P / 50.00P, or High Frame Rate movies normally, because playback is processing-intensive.
- Apparent resolution and noise vary slightly depending on the movie recording size, cropped recording setting, and lens used.

📄 Note

- To obtain better performance with the card, formatting the card with the camera before recording movies is recommended (🔗).
- Movies cannot be recorded in HD or VGA quality.

With [📷: HDMI RAW output] set to [On] (🔗)

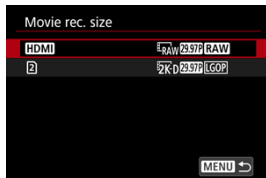

● **HDMI**

You can set the resolution, frame rate, and type of RAW for HDMI RAW movie output. The following combinations of movie recording quality options are available.

System Frequency	Resolution	Image Size	Frame Rate	Type of RAW
54.94 Hz: NTSC	RAW	8192×4320	29.97P 24.00P 23.98P	RAW
50.00 Hz: PAL			25.00P 24.00P	
54.94 Hz: NTSC	5RAW	4096×2160	59.94P 29.97P 24.00P 23.98P	
50.00 Hz: PAL			50.00P 25.00P 24.00P	

● (2)

You can set the compression method of movies recorded to card (2) at the same time. The movie recording format is [XF-AVC S YCC420 8bit], and the frame rate corresponds to the frame rate setting for HDMI RAW movie output. The following combinations of movie recording quality options are available.

System Frequency	Resolution	Image Size	Frame Rate	Compression Method
54.94 Hz: NTSC	2K-D	2048×1080	29.97P	LGOP LGOP+ 📶
50.00 Hz: PAL			25.00P	

⚠ **Caution**

- If you change the [🔊: System frequency] setting, also set [📷: Movie rec. size] again.
- Other devices may not play movies such as 8K/4K/2K, FHD 59.94P / 50.00P, or High Frame Rate movies normally, because playback is processing-intensive.
- Apparent resolution and noise vary slightly depending on the movie recording size, cropped recording setting, and lens used.

Note

- To obtain better performance with the card, formatting the card with the camera before recording movies is recommended (🔗).
- Movies cannot be recorded in HD or VGA quality.

8K/4K Movie Recording





- Recording 8K or 4K movies requires a stable card with a fast writing speed. For details, see [Cards That Can Record Movies](#).
- 8K/4K movie recording greatly increases the processing load, which may increase the internal camera temperature faster or higher than for regular movies. **Display of [🔥👉], white [🔥], or red [🔥] icons during movie recording warns that cards may be hot, so if you need to remove them, stop recording for a while before removal, and do not remove them immediately.**
- From a 8K or 4K movie, you can select any frame to save to the card as a JPEG still image (🔗).
- HDMI video output of 8K movies results in 4K movies.

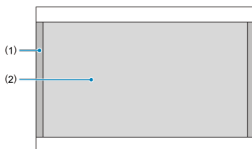

Image Area

The movie image area varies depending on factors such as movie recording quality and cropped shooting settings and the lens used.

- RF or EF lenses: With : **Movie cropping**] set to **[Disable]**





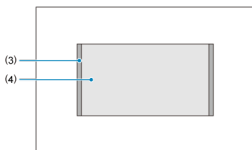

(1)  **RAW** (8K RAW)  **8K-D** (8192×4320) /  **5RAW** (4K RAW)  **4K-D** (4096×2160) /  **2K-D** (2048×1080)

(2)  **8K-U** (7680×4320) /  **4K-U** (3840×2160) /  **FHD** (1920×1080)

- RF or EF lenses: With : **Movie cropping**] set to **[Enable]**
- RF-S or EF-S lenses



(3)  **4K-D** (4096×2160) /  **2K-D** (2048×1080)

(4)  **4K-U** (3840×2160) /  **FHD** (1920×1080)

Caution

- Recording with Movie digital IS () further crops the image around the center of the screen.

Frame Rate (fps: frames per second)

- **239.8P: 239.76 fps / 119.9P: 119.88 fps / 59.94P: 59.94 fps / 29.97P: 29.97 fps**

For areas where the TV system is NTSC (North America, Japan, South Korea, Mexico, etc.).





- **200.0P: 200.00 fps / 100.0P: 100.00 fps / 50.00P: 50.00 fps / 25.00P: 25.00 fps**

For areas where the TV system is PAL (Europe, Russia, China, Australia, etc.).

- **24.00P: 24.00 fps / 23.98P: 23.98 fps**

Mainly for cinematic purposes. **23.98P** (23.98 fps) is available when [**System frequency**] is set to **[59.94Hz:NTSC]**.

Compression Method

- **Intra** : **High (Intra-frame)**
Compresses each frame, one at a time, for recording. Although file sizes are larger than with Long GOP, movies are more suitable for editing. Available when **[Main rec. format]** is set to **[XF-AVC S YCC422 10bit]**.
- **Intra**: **Standard (Intra-frame)**
Because file sizes are smaller than with **Intra** , movie recording over longer periods is possible with a card of the same capacity. Available when the resolution is set to **8K-D/8K-U** or when **[Main rec. format]** set to **[XF-AVC S YCC422 10bit]**.
- **Intra** : **Light (Intra-frame)**
Enables smaller file sizes than with **Intra** because movies are recorded at lower bit rates, and these movies can be played on more devices. This offers a longer available recording time than **Intra** with a card of the same capacity. Available when the resolution is set to **8K-D/8K-U** or when **[Main rec. format]** set to **[XF-AVC S YCC422 10bit]**.
- **LGOP**: **Standard (Long GOP)** / **LGOP** : **Light (Long GOP)**
Compresses multiple frames at a time efficiently for recording. Because file sizes are smaller than with intra-frame, movie recording over longer periods is possible with a card of the same capacity.

Cards That Can Record Movies

For details on cards that can record movies, see [Cards That Can Record Movies](#). See [Estimated recording time, movie bit rate, file size, and card performance requirements](#) for details on SD cards.

Test cards by recording a few movies to make sure they can record correctly at your specified size (🔗).

Caution

- Before recording 8K or 4K movies, format cards by selecting [**Low level format**] in [**🔗: Format card**] (🔗).
- If you use a slow-writing card when recording movies, the movie may not be recorded properly. Also, if you play back a movie on a card with a slow reading speed, the movie may not be played back properly.
- When recording movies, use high-performance cards with a writing speed sufficiently higher than the bit rate.
- When movies cannot be recorded properly, format the card and try again. If formatting the card does not resolve the problem, refer to the card manufacturer's website, etc.
- Recording to SD cards may not be possible, depending on the movie recording size. Pressing the movie shooting button will not start recording. For details, see [Specifications](#).

Note

- To obtain better performance with the card, formatting the card with the camera before recording movies is recommended (🔗).
- To check the card's writing/reading speed, refer to the card manufacturer's website, etc.

Movie Files Exceeding 4 GB

- Individual movie files exceeding 4 GB cannot be recorded to SD cards.
- With SDHC cards, once the movie file size reaches 4 GB, a new movie file is created automatically. During playback, these files are automatically played consecutively.
- With CFexpress or SDXC cards, individual movies are recorded as a single file, even if they exceed 4 GB.

Caution

- When importing movie files exceeding 4 GB to a computer, use either EOS Utility or a card reader (🔗). It may not be possible to save movie files exceeding 4 GB if you attempt this using standard features of the computer's operating system.
- Multiple files are displayed for any single movie file exceeding 4 GB that you transfer from an SDHC card to a computer. Deleting the first file will prevent playback of the remaining movie files.
- When connecting to a computer with an interface cable, do not use the computer to delete movie files on the camera. Movie files may not be recognized correctly.

Total Movie Recording Time and File Size Per Minute

See [Estimated recording time, movie bit rate, file size, and card performance requirements.](#)

High Frame Rate

When set to **[Enable]**, the camera can capture 239.76/200.00 fps or 119.88/100.00 fps to record movie files with a frame rate of 29.97/25.00 fps.

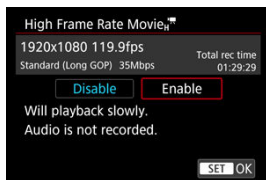

- The maximum recording time per movie is 89 min. 29 sec.
- Sound is not recorded. Note that playback is in slow motion.
- **239.8P/200.0P** is available at resolutions of **2K-D/FHD**.
- The compression method is **LGOP**.
- Count-up of time code display during movie recording is based on 29.97/25.00 fps.

Caution

- Time codes are not recorded when **[Count up]** is set to **[Free run]** in **[Time code]**.
- Check the **[Movie rec. size]** setting if you return this setting to **[Disable]**.
- The screen may flicker if you record High Frame Rate movies under fluorescent or LED lighting.
- For a moment when you start or stop recording High Frame Rate movies, the movie is not updated, and the frame stops momentarily. Be aware of this when recording movies to external devices via HDMI.
- Movie frame rates shown on the screen as you record High Frame Rate movies do not correspond to the frame rate of the movie recorded.
- Headphones cannot be used (no sound is audible).
- The frame rate of HDMI video output is 59.94 fps or 50.00 fps.
- The camera's internal temperature may rise and less recording time may be available after extended movie playback or image display.
- Movie digital IS may not provide sufficient stabilization when a macro lens is used to shoot subjects near the closest focusing distance.



Main Recording Format

[XF-HEVC S and XF-AVC S Movies](#)

[RAW Movies](#)

[Recording Proxy Movies](#)

You can specify the format of movie files recorded.

1. Select [: Main rec. format] ().
2. Select an option.

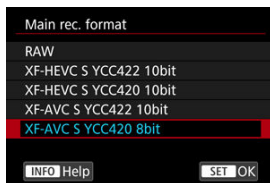

XF-HEVC S and XF-AVC S Movies

XF-HEVC S and XF-AVC S movies are in original Canon video formats that are extensions of H.265/HEVC and MPEG-4 AVC/H.264, respectively. These formats maintain image quality while offering high data compression.

Main Recording Format	Codec	Brightness, Hue, Saturation (YCbCr)/Color Depth	Description	Restrictions
XF-HEVC S YCC422 10bit	H.265/ HEVC	4:2:2/10-bit	XF-HEVC S can be used to record 10-bit YCC 4:2:2 signals. It is assumed that this material will be edited on a computer.	May not be played back correctly by some software.
XF-HEVC S YCC420 10bit	H.265/ HEVC	4:2:0/10-bit	XF-HEVC S can be used to record 10-bit YCC 4:2:0 signals.	—
XF-AVC S YCC420 8bit	MPEG-4 AVC/H.264	4:2:0/8-bit	XF-AVC S can be used to record 8-bit YCC 4:2:0 signals. A recording format with wide playback compatibility in software.	Not available with  HDR shooting (PQ) set to [HDR PQ] .
XF-AVC S YCC422 10bit	MPEG-4 AVC/H.264	4:2:2/10-bit	XF-AVC S can be used to record 10-bit YCC 4:2:2 signals. It is assumed that this material will be edited on a computer.	May not be played back correctly by some software.













Note

- Consider selecting a 10-bit recording format for custom picture files with a color space set to **[C.Gamut]** or **[BT.2020]** ().



RAW Movies

RAW movies consist of raw data from the image sensor in a digital form. You can use Digital Photo Professional (EOS software) to view and process RAW movies. For details, refer to the Digital Photo Professional instruction manual.

Caution

- RAW movies cannot be processed with [ : RAW image processing].
- [RAW] is not available in these cases.
 - [ Digital IS] in [ : IS (Image Stabilizer) mode] is set to an option other than [Off]
 - [ : Movie cropping] is set to [Enable]
 - [ : Dual shooting (still&movie)] is set to [On]
 - The camera is connected by USB after you have selected [Video calls/streaming] in [ : Choose USB connection app]
 - With RF-S or EF-S lenses attached
- RAW movie playback may cause the camera to become hot internally, which may cause movie playback to stop automatically.
- Consider using two cards when you record RAW movies, so that you can also record a proxy movie and use it for playback.
- Set [ Rec options] in [ : Record func+card/folder sel.] to [ Main  Proxy] and [ Play] to [].

Note

- To display RAW movies on a computer, using Digital Photo Professional (EOS software, hereafter DPP) is recommended.
- RAW images from this camera cannot be used with older versions of DPP. Download the latest version of DPP from the Canon website and install it, which will overwrite the previous version ().
- Commercially available software may not be able to display RAW movies recorded by this camera. For compatibility information, contact the software manufacturer.
- To prioritize gradation in highlights, consider setting [ CP function] in [ : Custom Picture] to [On].

Recording Proxy Movies

To record one version of movies to card **[1]** in the main recording format while recording another version to card **[2]** in a lighter format, set **[P: Rec options]** in **[F: Record func +card/folder sel.]** to **[1]Main [2]Proxy**. This is referred to as "proxy movie recording." **[C: Main rec. format]** settings apply to card **[1]**, where main movies are recorded. For the recording settings used to record proxy movies to card **[2]**, the following items are set automatically based on card **[1]** settings.

- Recording Format
- Resolution
- Frame Rate

Main movie settings correspond to the following, automatically configured proxy movie settings.

Main Movie Settings		Proxy Movie Settings (Set Automatically)	
Recording Format	Image Size	Recording Format	Image Size
XF-HEVC S YCC422 10bit XF-HEVC S YCC420 10bit	4096×2160	XF-HEVC S YCC420 10bit	2048×1080
	2048×1080		1920×1080
	3840×2160		
	1920×1080		
XF-AVC S YCC420 8bit XF-AVC S YCC422 10bit	4096×2160	XF-AVC S YCC420 8bit	2048×1080
	2048×1080		1920×1080
	3840×2160		
	1920×1080		
RAW	8192×4320	XF-AVC S YCC420 8bit	2048×1080
	4096×2160		

* Proxy movie frame rates match main movie frame rates.

* Frame rates cannot be set higher than 100 fps.

* Among proxy movie compression methods, only for bit rate, you can choose a **[Compression]** option (**[LGO]: Standard (Long GOP) 16 Mbps**) or (**[LGO]: Light (Long GOP) 9 Mbps**) for **[2]** below **[C: Movie rec. size]**.

Caution

- Recording proxy movies takes as much time as recording main movies. When recording stops for a main movie, recording also stops for the proxy movie. However, main movie recording continues even if errors stop proxy movie recording.
- Icons on the movie recording screen indicate whether recording is possible for main and proxy movies.
Main movie: **1** (recording possible), **1o** (recording not possible)
Proxy movie: **2** (recording possible), **2o** (recording not possible)
- Gradation of the sky, white walls, or similar image areas may not be reproduced smoothly in proxy movies under some shooting conditions.





Note

- On the movie recording screen, the amount of time remaining for movie recording refers to the time for main movies. If card **1** (for main movies) is not in the camera, the amount of time remaining for movie recording refers to the time for card **2** (proxy movies).



With RF or EF lenses, you can record movies cropped around the center of the image area, as if captured with a telephoto lens.

Recording movies with RF-S/EF-S lenses has the same effect as this movie cropping feature.

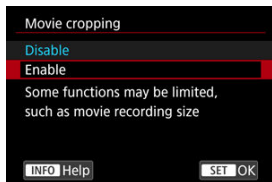
1. Select [: Movie cropping] ().
2. Select [Enable].



Caution

- The center of the screen is further cropped, reducing the recording area, when [ **Digital IS**] in [: **IS (Image Stabilizer) mode**] is set to [On] or [Enhanced].

Note

- The recording area available with movie cropping is the same as when recording movies with RF-S/EF-S lenses.
- For details on the recording area, see [Image Area](#).

Without interrupting movie recording, you can shoot still photos (single shooting or continuous shooting) by pressing the shutter button completely. This enables still photo shooting with higher image quality than extracting frames from movies.

⚠ Caution

- When using this feature, make sure two cards are in the camera before turning it on. Having only one card in the camera when you turn it on will prevent both movie recording and still photo shooting.
- To record movies with only one card inserted, switch to still photo shooting mode and press the movie shooting button. [⏏] settings are applied in movie recording.

📄 Note

- Movies are recorded in Full HD image quality (1920×1080). Still photos are captured as JPEGs with an aspect ratio of 16:9 (7680×4320).
- Movies are recorded to card [1] and still photos to card [2].

1. Select [📷: Dual shooting (still&movie)] (🔗).
2. Select [Dual shooting (still&movie)].

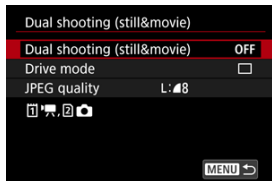

3. Select [On].

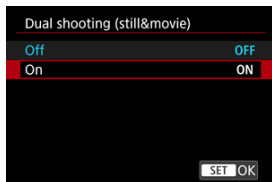

4. Set other options as needed.

Drive mode

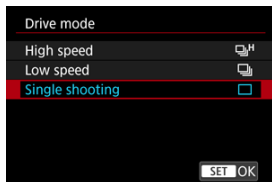

- Specify the amount of still photo shooting performed by pressing the shutter button completely. Turn the < > dial to make a selection.

High speed

- With [: **System frequency**] set to [59.94Hz:NTSC]: Continuous shooting at up to approx. 7.5 shots/sec. while pressed
- With [: **System frequency**] set to [50.00Hz:PAL]: Continuous shooting at up to approx. 6.2 shots/sec. while pressed

Low speed

- With [: **System frequency**] set to [59.94Hz:NTSC]: Continuous shooting at up to approx. 5 shots/sec. while pressed
- With [: **System frequency**] set to [50.00Hz:PAL]: Continuous shooting at up to approx. 4.1 shots/sec. while pressed

Single shooting



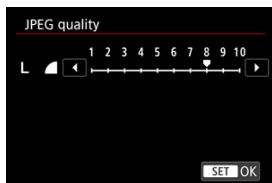

Single-image shooting

JPEG quality





- Set the level of image quality (1–10) in still photo shooting. Turn the  dial to make a selection.
- Higher numbers offer higher quality (lower compression).

Caution

- Still photos cannot be captured during movie recording when RF-S or EF-S lenses are attached.
- Faces in still photos may appear dark, or colors may look different from those in normal still photo shooting, because settings for movie recording are used for autofocus, exposure, and white balance.
- The shutter-release time lag for single shooting of still photos may be longer under the following shooting conditions. Continuous shooting is also slower.
 - Shooting under low light with :  **Auto slow shutter**] set to **[Enable]**
 - Using a slow shutter speed in **[Tv]** or **[M]** mode
 - Setting : **Standby: Low res.**] to **[On]** and only shooting still photos
- Still photos cannot be transferred during movie recording.
- Some features are not available with : **Dual shooting (still&movie)**] set to **[On]**. Some limitations also apply to movie recording sizes and anti-flicker shooting.
- Magnification from the point in focus is not available for still photos captured with this feature. Similarly, in-camera resizing, cropping, and upscaling are not available.

Note

- You can extend the time available for movie recording by setting : **Standby: Low res.**] to **[On]**.
- As the Picture Style for still photos, the setting of : **Picture Style**] during movie recording is applied.

Sound Recording

Select **[On]** for sound recording during movie recording. The built-in microphone is used unless an external microphone is connected.

1. Select **[📷: Sound recording] (🔗)**.
2. Select an option.

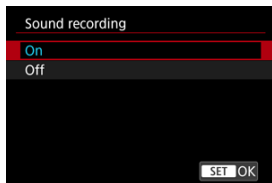

- Set the recording level and other settings as needed in **[📷: Audio settings] (🔗)**.
- **[📷: Audio settings]** is not available in **[📷^A]** mode. Here, the sound-recording level is adjusted automatically.

⚠ Caution

- Sounds from Wi-Fi operations may be captured with built-in or external microphones. During sound recording, using the wireless communication function is not recommended.
- Make sure any output plugs of external microphones or any headphone jacks are fully inserted in the camera.
- The camera's built-in microphone may also record mechanical sounds of the lens or sounds of camera/lens operations if AF operations are performed or the camera or lens is operated during movie recording. If so, it may help reduce these sounds if you use an external microphone equipped with an output plug and position it away from the camera and lens.
- Do not connect anything other than an external microphone to the camera's external microphone IN terminal.
- Sound that is recorded using four-channel recording may not be played correctly by some software.



Note

- Audio is also output when the camera is connected to televisions via HDMI, except when set to **[Disable]**. In case of feedback from television audio output, move the camera away from the television or turn down the volume.
- The volume balance between L/R (left/right) cannot be adjusted.
- Sound is recorded at a 48 kHz sampling rate.

Four-channel recording

The camera supports four-channel sound recording.



Four-channel recording can include combinations of the following sources.

- Microphone designed for a multi-function shoe (2 channels) + external microphone (2 channels)
- Microphone designed for a multi-function shoe (2 channels) + built-in microphone (2 channels)
- External microphone (2 channels) + built-in microphone (2 channels)
- Built-in microphone (2 channels) + built-in microphone (2 channels)



When multiple microphones are connected, the one with higher priority is assigned to channels 1 and 2, and the lower-priority one is assigned to channels 3 and 4. Microphones have the following priority, from highest to lowest.

- Microphones designed for a multi-function shoe
- External microphones
- Built-in microphone

Caution

- Four-channel sound recording (with multiple microphones) is available with : **Audio format** set to **[LPCM/24bit/4CH]**. Setting : **Audio format** to **[AAC/16bit/2CH]** restricts sound recording to two channels (with a single microphone).
- Movie files recorded with **[LPCM/24bit/4CH]** selected may not be played correctly by some software.

Note

- To check which microphone input is currently enabled, access : **Audio Status** ().

Audio Format

You can choose the audio format used for sound in movie recording.

1. Select [📷: Audio format] (🔗).

2. Select an option.

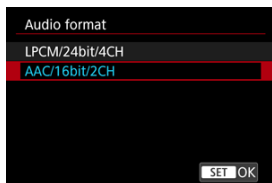

When set to [1]Main [2]Proxy]

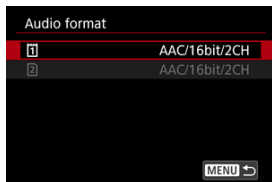

- When [🗨️ Rec options] in [📷: Record func+card/folder sel.] is set to [1]Main [2]Proxy], select the audio format for each card.

⚠ Caution

- The audio format of HDMI output when [HDMI RAW output] is set to [On] is locked to [LPCM/16bit/2CH].
- The setting on card [2] cannot be changed when card [1] is set to [AAC/16bit/2CH].
- Selecting [LPCM/24bit/4CH] enables four-channel sound recording (with multiple microphones). Selecting [AAC/16bit/2CH] restricts recording to two channels (with a single microphone).
- Sound that is recorded using four-channel recording may not be played correctly by some software.

Audio Settings

- [Recording Mode](#)
- [Recording Level](#)
- [Wind Filter](#)
- [Attenuator](#)
- [Microphone Directionality](#)

Configure microphones for sound recording in these settings. When using microphones that are external or designed for a multi-function shoe, also refer to the microphone instruction manual.

1. Select [: Audio settings] ().
2. Select the device to use.

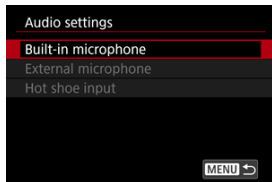

- **Built-in microphone**
For configuring settings for the built-in microphone.
- **External microphone**
For configuring settings for external microphones that use the external microphone IN terminal.
- **Hot shoe input**
For configuring settings for microphones designed for a multi-function shoe.

Recording Mode

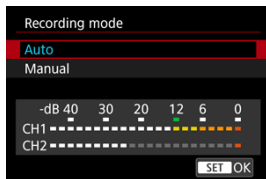

- **Auto**

The sound-recording level is adjusted automatically. Auto level control will take effect automatically in response to the sound level.

- **Manual**

You can adjust the sound-recording level as needed. Adjust the level in **[Rec. level]**.

Caution

- Do not change the **[Recording mode]** settings when listening with headphones. This may cause sudden loud output that may hurt your ears.

Note

- Recording levels are shown in the level meter at the bottom of the screen.

Recording Level

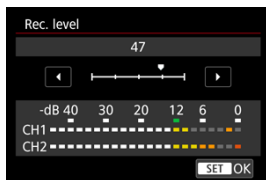

Available when [Recording mode] is set to [Manual].

To adjust the sound-recording level, turn the <  > dial while watching the level meter. Look at the peak hold indicator, and adjust so that the level meter sometimes lights up on the right of the "12" (-12 dB) mark for the loudest sounds. If it exceeds "0", the sound will be distorted.

Wind Filter

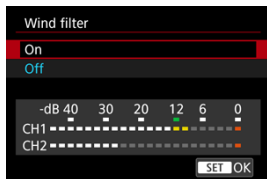

Available when using the built-in microphone or multi-function shoe microphones that are compatible with wind filters.

Set to **[Enable]** to reduce wind noise when there is wind outdoors. When the wind filter function takes effect, part of the low bass sounds will also be reduced.

Attenuator

As a function that suppresses sound distortion caused by loud noises during recording, the attenuator can be enabled or disabled when using microphones designed for a multi-function shoe. For details, refer to the microphone instruction manual.

Microphone Directionality

Available when using multi-function shoe microphones for which directivity can be switched. For details, refer to the microphone instruction manual.

Audio Status

Indicates audio status such as the active microphone and the headphone volume.

1. Select [: Audio Status] ().

2. Check the details as needed.

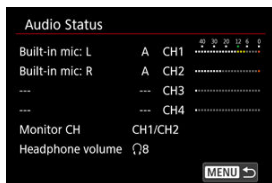

Note

- [Monitor CH] indicates channels set in [Shoot. monitor CH] for [Headphones] in [: Audio monitor].

- [✔ Selecting Custom Picture Files](#)
- [✔ Editing Custom Pictures](#)
- [✔ Custom Picture Setting Items](#)
- [✔ Checking Custom Picture Settings](#)
- [✔ Saving and Loading Custom Picture Files](#)
- [✔ Using Look Files](#)
- [✔ Canon Log Image Quality](#)

Custom picture files on the camera enable you to adjust color tones in movie recording by applying a combination of settings (gamma/color space, color matrix, and look files), mainly in preparation for post-production processing.

- You can select a custom picture file to record movies with your preferred image characteristics.
- Preset custom picture files can be edited to create new ones.
- To adjust movie color tones, you can register look files.

! **Caution**

- Applying custom pictures may change the metering level.

Selecting Custom Picture Files

1. Select [📷: Custom Picture] (🔗).
2. Select [CP function].

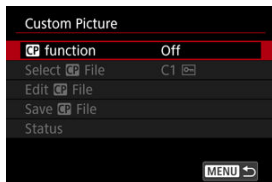

3. Select [On].

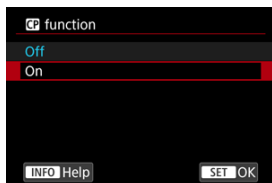

4. Select [Select CP File].

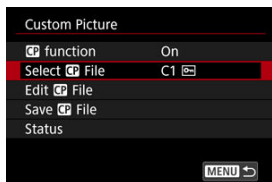

5. Select a custom picture file.

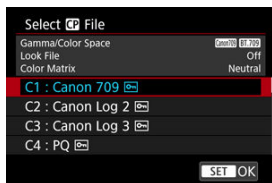

Custom Picture File	Gamma/Color Space	Look File	Color Matrix	Summary
C1: Canon 709	Canon 709 / BT.709	Off	Neutral	Wider dynamic range than BT.709 Standard Suitable for display on BT.709 compliant-monitors Also suitable without post-processing
C2: Canon Log 2	Canon Log 2 / C.Gamut	Off	Neutral	Uses Canon Log 2 gamma; post-processing required Superior tonality in dark image areas than Canon Log 3
C3: Canon Log 3	Canon Log 3 / C.Gamut	Off	Neutral	Uses Canon Log 3 gamma; post-processing required Retains Canon Log characteristics while expanding the dynamic range
C4: PQ	PQ / BT.2020	Off	Neutral	Uses an HDR gamma curve compliant with the ITU-R BT.2100 (PQ) standard (in 8-bit recording, equivalent to the ITU-R BT.2100 (PQ) standard)
C5: HLG	HLG / BT.2020	Off	Neutral	Uses an HDR gamma curve compliant with the ITU-R BT.2100 (HLG) standard (in 8-bit recording, equivalent to the ITU-R BT.2100 (HLG) standard)
C6: BT.709 Standard	BT.709 Standard / BT.709	Off	Video	Suitable for display on BT.709 compliant-monitors Uses a gamma curve compliant with the ITU-R BT.709 standard
C7 to C20 (User07 to User20)	Canon 709 / BT.709	Off	Neutral	Wider dynamic range than BT.709 Standard Suitable for display on BT.709 compliant-monitors Also suitable without post-processing

Editing Custom Pictures

You can edit settings of the selected custom picture file.

1. Select [Edit **CP** File].

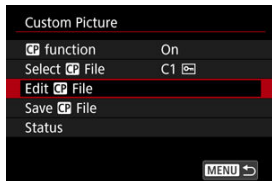

- To edit a protected ([**On**]) custom picture file, select [**Unprotect**] by [**Protect**] to enable editing.

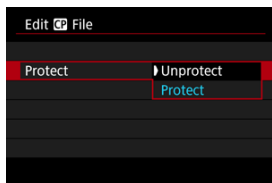

2. Edit the settings as needed.

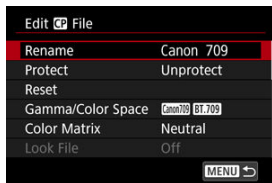

- Select a setting to edit, then adjust it on the screen displayed (.
- To save an edited custom picture file with a new name, select [**Rename**] and enter a name.
- To reset editing, select [**Reset**], then select the custom picture file to reset.
- For instructions on look files, see [Using Look Files](#).

3. Protect the image.

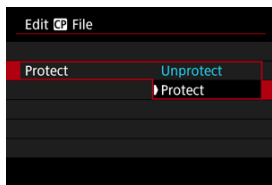

- When you are finished editing, select [**Protect**].

Custom Picture Setting Items

The following items can be set by using [Edit  File].

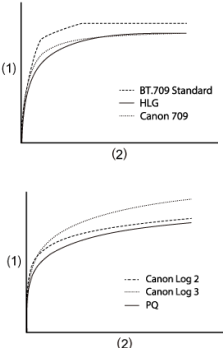
Setting Item		Description
Gamma/Color Space		
Set the combination of gamma curve and color space		
Gamma	(1) Output (2) Input	
	Canon Log 2	Gamma with richer gradation in dark image areas than Canon Log 3 Requires image processing in post-production
	Canon Log 3	Gamma that retains Canon Log characteristics but with expanded dynamic range Requires image processing in post-production
	PQ	HDR gamma compliant with the ITU-R BT.2100 (PQ) standard (in 8-bit recording, equivalent to the ITU-R BT.2100 (PQ) standard)
	HLG	HDR gamma compliant with the ITU-R BT.2100 (HLG) standard (in 8-bit recording, equivalent to the ITU-R BT.2100 (HLG) standard)
	BT.709 Standard	Gamma compliant with the ITU-R BT.709 standard Suitable for display on BT.709 compliant-monitors
	Canon 709	Gamma with a wide dynamic range that is also suitable without post-processing Suitable for viewing on BT.709 compliant-monitors
Color space	C.Gamut	Color space developed by Canon based on image sensor characteristics, covering a wider color gamut than that of BT.2020 Also recommended when converting to the ACES2065-1 color space
	BT.2020	Color space compliant with the ITU-R BT.2020 standard for UHDTV (4K/8K)
	BT.709	Standard color space compliant with sRGB standards

Color Matrix		
Color reproduction setting		
	Neutral	Faithful color reproduction
	Production Camera	Cinematic color reproduction
	Video	Color reproduction with a contrast for broadcast TV
Look File		
Use of look files		
	On	Enables color adjustment based on look files
	Off	Disables color adjustment based on look files
Look File Setup		
Look file registration/removal		
	Register	Registers look files (.cube format) to custom pictures
	Delete	Removes look files registered to custom pictures
HLG Color		
Hybrid log-gamma (HLG) color setting		
Available when the [Gamma/Color Space] gamma is set to [HLG] and color space is [BT.2020]		
	BT.2100	Color equivalent to ITU-R BT.2100
	Vivid	Color equivalent to "traditional color" in ITU-R BT.2390
Black		
Black level adjustment		
Not available with [Gamma/Color Space] set to [Canon Log 2] or [Canon Log 3]		
Master Pedestal	-50 to +50	Increases or decreases the black level. Higher values brighten dark image areas but decrease contrast. Negative values darken blacks.
Master Black Red Master Black Green Master Black Blue	-50 to +50	Corrects red, green, or blue color cast in blacks

Black Gamma**Lower gamma curve correction, for dark image areas**

Raises or lowers the black part of the gamma curve in the following ranges

Available with [Gamma/Color Space] set to [BT.709 Standard]

- (1) Output
 (2) Input
 (3) Point
 (4) Level
 (5) Range

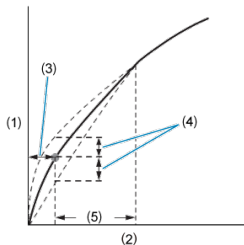

Level	-50 to +50	Sets the height of the lower gamma curve
Range	-20 to +50	Sets the adjustment range, relative to [Point]
Point		Sets the vertex position
Low Key Saturation		
Color saturation adjustment in dark image areas		
Activate	On, Off	Adjustment is enabled when set to [On]
Level	-50 to +50	Sets the amount of adjustment

Knee**Compression of bright image areas to prevent clipped highlights**

Available with [Gamma/Color Space] set to [BT.709 Standard]

(1) Output

(2) Input

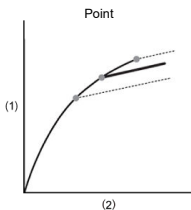
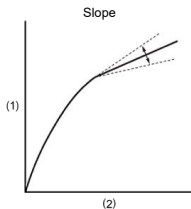

Activate	On, Off	Adjustment with each setting is enabled when set to [On]
Slope	-35 to +50	Adjusts the slope above the knee point
Point	50 to 109	Adjusts the knee point
Saturation	-10 to +10	Adjusts color saturation in bright image areas

Sharpness		
Sharpness adjustment		
Level	-10 to +50	Increases or decreases the level of edge sharpness
Detail Frequency	-8 to +8	Sets the center frequency for edge enhancement Higher values increase the frequency, sharpening images
Coring Level	-30 to +50	Sets the contrast threshold between edges and surrounding image areas, which determines edge enhancement Higher values prevent emphasizing subtle details, reducing noise
Limit	-50 to +50	Restricts the amount of edge enhancement
Noise Reduction		
Reduction of image noise		
Automatic	On, Off	Automatically adjusted when set to [On]
Spatial Filter	Off, 1 to 12	Reduces noise by applying a soft focus-like effect to the entire image Although no artifacts are produced, the image as a whole is softened when set to an option other than [Off]
Frame Correlation	Off, 1 to 3	Reduces noise by comparing current and previous images (fields) when set to a value other than off Although apparent resolution is not affected, moving subjects may result in artifacts
Skin Detail		
Skin-softening settings		
Controls skin tone detection and noise reduction		
Detected skin tone areas are displayed with a zebra pattern		
Effect Level	Off, Low, Middle, High	Sets the level of the skin-softening filter, with [High] as the highest level
Hue	-16 to +16	Sets the hue of skin tone to detect
Chroma	0 to 31	Sets the saturation of skin tone to detect
Area		Sets the color range of skin tone to detect
Y Level		Sets the brightness of skin tone to detect
Color Matrix Tuning		
Fine-tuning of image color tones		
Gain	-50 to +50	Adjusts color intensity
Phase	-18 to +18	Adjusts hue
R-G	-50 to +50	Adjusts tint between cyan to green and between red to magenta
R-B		Adjusts tint between cyan to blue and between red to yellow
G-R		Adjusts tint between magenta to red and between green to cyan
G-B		Adjusts tint between magenta to blue and between green to yellow
B-R		Adjusts tint between yellow to red and between blue to cyan
B-G		Adjusts tint between yellow to green and between blue to magenta

Color Correction		
Settings to correct image areas with certain color characteristics		
Areas for correction are detected accordingly		
With the settings configured, areas not detected are displayed in neutral colors (except when adjusting [Area A Revision Level], [Area B Revision Level], [Area A Revision Phase], and [Area B Revision Phase])		
Select Area	Off, Area A, Area B, Area A&B	Specifies areas (A or B) for color correction Area A is corrected when set to [Area A] Area B is corrected when set to [Area B] Both areas are corrected when set to [Area A&B]
Area A Setting Phase	0 to 31	Sets the color phase of Area A
Area B Setting Phase		Sets the color phase of Area B
Area A Setting Chroma		Sets the saturation of Area A
Area B Setting Chroma		Sets the saturation of Area B
Area A Setting Area		Sets the color range of Area A
Area B Setting Area		Sets the color range of Area B
Area A Setting Y Level		Sets the brightness of Area A
Area B Setting Y Level		Sets the brightness of Area B
Area A Revision Level	-50 to +50	Sets the amount of correction applied to saturation in Area A
Area B Revision Level		Sets the amount of correction applied to saturation in Area B
Area A Revision Phase	-18 to +18	Sets the amount of correction applied to the color phase of Area A
Area B Revision Phase		Sets the amount of correction applied to the color phase of Area B
Other Functions		
[Over 100%] determines how the camera handles signals exceeding 100%		
Available with [Gamma/Color Space] set to [BT.709 Standard]		
Over 100%	Through	Unmodified output
	Press	Compresses signals that are up to 108% so that they are at 100% levels
	Clip	Discards portions of signals exceeding 100%

Checking Custom Picture Settings

You can review custom picture file settings from the [Custom Picture] menu.

1. Select a custom picture file (P).
2. On the [Custom Picture] screen, select [Status].

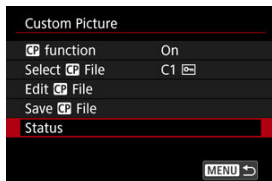

3. Check the settings.

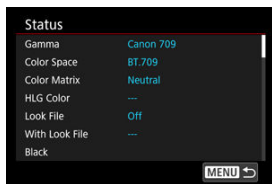

Saving and Loading Custom Picture Files

Edited custom picture files can be saved to a card and used with other cameras of the same model.

1. Select a custom picture file to save (🔗).
2. On the [Custom Picture] screen, select [Save 📁 File].

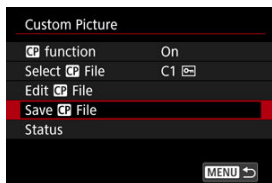

3. Select an option.

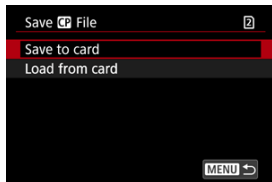

- **Save to card**
Saves the edited custom picture file. Select a destination, then select [OK].
Up to 20 files can be saved. [New File] is displayed when you save the file, unless more than 20 files have already been saved. If 20 files have been saved, the files are overwritten with new files you save.
- **Load from card**
Loads a custom picture file from a card. Select the file to load, then select [OK].

Using Look Files

You can register 17- or 33-grid 3D LUT files in .cube format from the Blackmagic Design application DaVinci Resolve as look files in custom picture files to adjust the color tone of movies you record.

Registering look files

Before you begin, the look file to register should be copied to a card.

1. Load the card in the camera.
2. Select a custom picture file (🔒).
3. Select [Edit 📄 File].

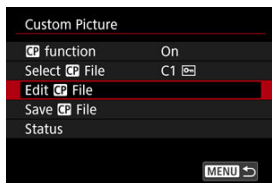

- To edit a protected ([🔒]) custom picture file, select [Unprotect] by [Protect] to enable editing.
- If you will edit a custom picture file and register a look file at the same time, do the look file registration last.

4. Select [Look File Setup].

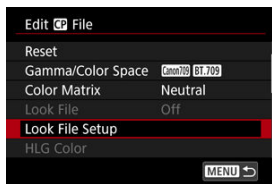

5. Select [Register].

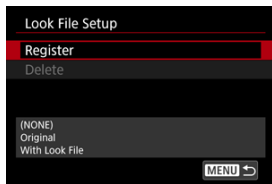

- Look files on the card are listed.

6. Select a look file.

7. After applying the look file, select the gamma/color space.

8. Select [OK].

⚠ Caution

- The following look files are not compatible.
 - Input range outside a range of 0–1 in the header (“LUT_3D_INPUT_RANGE”)
 - 2 MB or larger, or with names exceeding 65 characters (including file extension)
 - With file names that include unsupported characters
Supported characters: 0–9, a–z, A–Z, underscore (_), hyphen (-), period (.), or single-byte space
- Data section includes values outside a range of 0–1
- Color tones will not be converted correctly unless a suitable gamma/color space is used for input and output.
- A registered look file cannot be used if you change [Gamma/Color Space], [HLG Color], or [Over 100%] settings after registration.
- Signals above 100% or below 0% are not be used with [Gamma/Color Space] set to [BT.709 Standard]. Before registering look files for any signals above 100% that you will use, select [Press] in [Over 100%].
- Registered look files are applied to RAW movie thumbnails but not applied during playback.

Using look files for color adjustment

You can use registered look files for color adjustment.

1. On the [Edit  File] screen, select [Look File].
2. Select [On].
 - To disable color adjustment based on look files, select [Off].

Removing look files

1. Select a custom picture file ().
2. Select [Edit  File].

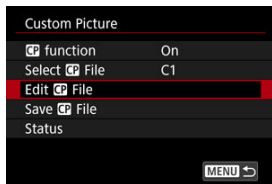

3. Select [Look File Setup].

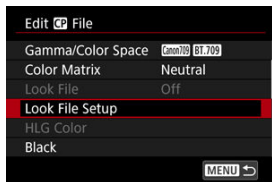







4. Select [Delete].

5. Select [OK].

Canon Log Image Quality

- With Canon Log, skies, white walls, and similar subjects may be affected by noise or uneven gradation, exposure, or colors, depending on the subject or shooting conditions. Banding or noise may also be noticeable in dark image areas.
- Noise may become more noticeable if you enhance the contrast or edit images in similar ways.
- Record a few test movies and check the results in advance.
- Image quality may improve if you change the ISO speed or, in post-production, perform color grading.

Caution

- With Canon Log, autofocus may be more difficult for subjects under low light, or for low-contrast subjects.
Difficulty in autofocus can be reduced by shooting near maximum aperture or using a bright lens.
- Noise may appear at image edges if **[Peripheral illum corr]** in : **Lens aberration correction** is set to **[Enable]** when Canon Log is set.
- Histograms with :     **HDR/C.Log View Assist.** set to **[On]** are not based on conversion for View Assist display. Image areas shown in gray in the histogram roughly indicate signal values that are not used.

[Shadow Compensation](#)

[Saturation](#)

[Limiting Maximum Brightness](#)

You can record high dynamic range movies that retain detail in highlights of high-contrast scenes.

1. Select [📷: HDR] [HDR Movie Mode] (🔗).
2. Set [HDR Movie Record.] to [Enable].

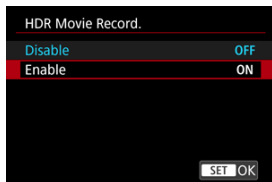

⚠ Caution

- The ISO speed range is ISO 800–12800.
- With HDR movie recording, skies, white walls, and similar subjects may be affected by noise or uneven gradation, exposure, or colors, depending on the subject or shooting conditions. Banding or noise may also be noticeable in dark image areas.
- Record a few test movies and check the results in advance.
- Image quality may improve if you change the ISO speed or the [📷: High ISO speed NR] or [Shadow comp.] settings.
- Autofocusing in HDR movie recording may be more difficult for subjects under low light, or for low-contrast subjects. Difficulty in autofocusing can be reduced by shooting near maximum aperture or using a bright lens.



Note

- For even better reproduction of bright image areas, also set the camera to [📷]:
[📷] **HDR shooting (PQ)** (🔗).

Shadow Compensation

You can brighten shadows and other dark image areas by using **[Shadow comp.]**.



- On the screen shown next, select an option while previewing the results.

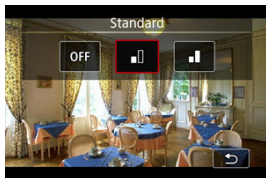





⚠ Caution

- Noise may increase and apparent resolution may change, under some shooting conditions. Subjects such as the sky or white walls may not be rendered with smooth gradation, and colors may look irregular.
- Banding noise may be noticeable in dark image areas. This noise may also occur at low ISO speeds, but changing the ISO speed or the **[📷: High ISO speed NR]** or **[Shadow comp.]** settings may make it less noticeable.

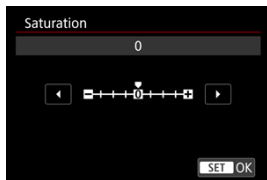
Saturation

You can adjust overall color intensity by using **[Saturation]**.



- To select an adjustment value, use the <  > or <  > dial.
- Press <  > when finished.

Limiting Maximum Brightness

This setting is available when [📷: 📺HDR shooting (PQ)] is set to [HDR PQ].

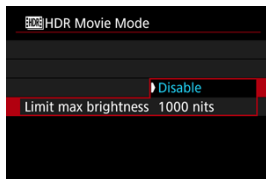

- With [**Disable**], maximum brightness is not limited. Recommended when you will review images on a monitor supporting display at brightnesses exceeding 1000 nits.
- With [**1000 nits**], maximum brightness is limited to approx. 1000 nits.

Time-Lapse Movies

[Approx. Time Available for Recording Time-Lapse Movies](#)

Still photos captured at a set interval are combined to create a time-lapse movie. This provides an accelerated view of processes that normally happen slowly, such as changes in a landscape, plant growth, or celestial motion.

1. Select [: Time-lapse movie] ().
2. Select [Time-lapse].

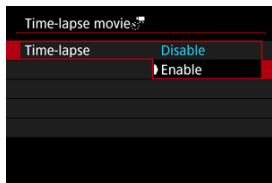

- Select [**Enable**].

3. Set [Interval].

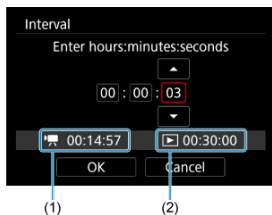

- As you set the number, refer to the [🔊] time required (1) and [▶] playback time (2).
- Turn the < ⌚ > dial to select an option (hours : minutes : seconds).
- Press < Ⓢ > to display [⏸].
- Set the desired number, then press < Ⓢ >. (Returns to [□].)
- Can be set in a range of [00:00:02]–[99:59:59]. (An interval of once per second is not available.)
- Select [OK] to register the setting.

4. Set [No. of shots].

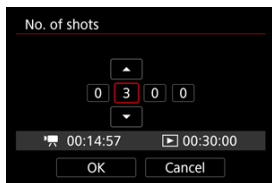

- As you set the number, refer to the time required ([]) and playback time ([]).
- Turn the < > dial to select an option (digit).
- Press < > to display [].
- Set the desired number, then press < >. (Returns to [].)
- Can be set in a range of [0002]–[3600].
- Make sure the playback time ([]) is not displayed in red.
- Select [OK] to register the setting.
- The playback time ([]) is displayed in red if the card does not have enough free space to record the specified number of shots. Although the camera can continue recording, the recording will stop when the card becomes full.
- Playback time ([]) is displayed in red if the [No. of shots] setting results in a file size exceeding 4 GB for a card not formatted in exFAT (). If you keep recording in this condition and the movie file size reaches 4 GB, the time-lapse movie recording will stop.



Note

- For details on cards that can record time-lapse movies (card performance requirements), see [Estimated recording time, movie bit rate, file size, and card performance requirements](#).
- If the number of shots is set to 3600, the time-lapse movie will be approx. 2 min. in NTSC and approx. 2 min. 24 sec. in PAL.

5. Select [Movie rec. size].

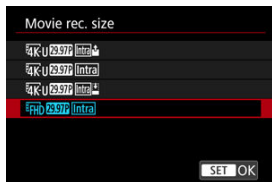

- Available movie recording sizes (a combination of resolution, frame rate, and compression) are displayed. Options vary depending on the **[Main rec. format]** setting.
For details on main recording formats, resolutions, frame rates, and compression, see [Main Recording Format](#) and [Movie Recording Size](#).
- With **[Main rec. format]** set to **[XF-HEVC S YCC422 10bit]**
 - NTSC: 8K-U 29.97P Intra, PAL: 8K-U 25.00P Intra
 - NTSC: 8K-U 29.97P Intra, PAL: 8K-U 25.00P Intra
- With **[Main rec. format]** set to **[XF-AVC S YCC422 10bit]** or **[XF-AVC S YCC420 8bit]**
 - NTSC: 4K-U 29.97P Intra, PAL: 4K-U 25.00P Intra
 - NTSC: 4K-U 29.97P Intra, PAL: 4K-U 25.00P Intra
 - NTSC: 4K-U 29.97P Intra, PAL: 4K-U 25.00P Intra
 - NTSC: FHD 29.97P Intra, PAL: FHD 25.00P Intra

⚠ Caution

- FHD is not available when **[Movie cropping]** is set to **[Enable]**, or with RF-S/EF-S lenses attached.

6. Select [Main rec. format].

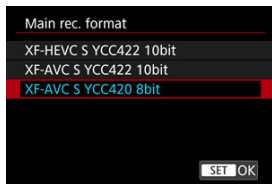

- The available main recording formats are listed.
- For details on these options, see [Main Recording Format](#).

7. Set [Auto exposure].

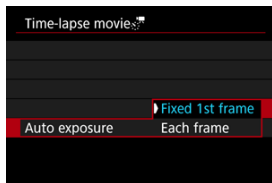

- **Fixed 1st frame**
When taking the first shot, metering is performed to set the exposure automatically to match the brightness. The exposure setting for the first shot will be applied to subsequent shots. Other shooting-related settings for the first shot will also be applied for subsequent shots.
- **Each frame**
Metering is also performed for each subsequent shot to set the exposure automatically to match the brightness. Note that any functions such as Picture Style and white balance that are set to **[Auto]** will be set automatically for each subsequent shot.

⚠ Caution

- Significant changes in brightness between shots may prevent the camera from shooting at the specified interval when **[Interval]** is set to less than 3 sec. and **[Auto exposure]** is set to **[Each frame]**.

8. Set [Screen auto off].

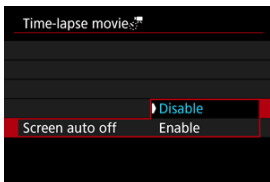

- **Disable**

Even during time-lapse movie recording, the image will be displayed. (The screen turns off only at the time of shooting.) Note that the screen will turn off when approx. 30 min. elapse after the shooting started.

- **Enable**

The screen will turn off when approx. 10 sec. elapse after the shooting started.

Caution

- Even if [**Screen auto off**] is set to [**Disable**], the screen turns off during exposure. Also note that images may not be displayed if the interval between shots is too brief.

Note

- During time-lapse movie recording, you can press the < **INFO** > button to turn on/off the screen.

9. Set [Beep per shot taken].

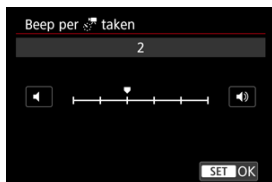

- Set to [0] to prevent the camera from beeping for each shot.

10. Check the settings.

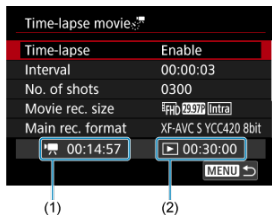

- **Time required (1)**
Indicates the time required to shoot the set number of shots with the set interval. If it exceeds 24 hours, "**** days" will be displayed.
- **Playback time (2)**
Length of the time-lapse movie.

11. Close the menu.

- Press the <MENU> button to turn off the menu screen.

12. Read the message.

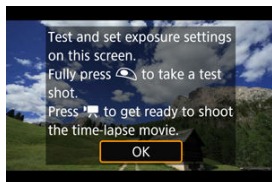

- Read the message and select [OK].



13. Take a test shot.



- Press the **< INFO >** button and double-check the time required (1) and interval (2) shown on the screen.
- Set the exposure and shooting functions, then focus.
- Press the shutter button completely to take a test shot, which is recorded to the card as a still photo.
- If there are no problems with the test shot, go to the next step.
- To take more test shots, repeat this step.



Note

- Test shots are captured in JPEG  quality.
- In [**M**] mode, you can set the shutter speed in a range of 1/4000 to 30 sec.
- You can set the maximum limit for Auto ISO in [**M**] mode or in [**M**] mode with ISO Auto, in the [**Max for Auto**] option of [**ISO speed settings**] ().
- If you have set [**Half-press**] in [**Shutter btn function for movies**] to [**Meter.+ Servo AF**], it is automatically changed to [**Meter.+One-Shot AF**] when you set up time-lapse movie recording.

14. Press the movie shooting button.

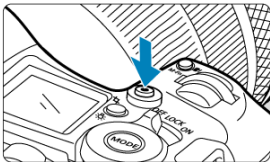

- The camera is now ready to start recording a time-lapse movie.
- To return to step 13, press the movie shooting button again.

15. Record the time-lapse movie.

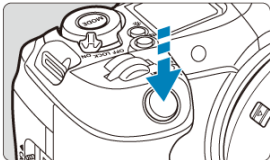

- **Press the shutter button completely to start recording the time-lapse movie.**
- AF will not work during time-lapse movie recording.
- A recording icon "●" is displayed on the screen as the time-lapse movie is recorded.
- When the set number of shots are taken, the time-lapse movie recording ends.
- **To cancel recording time-lapse movies, set [Time-lapse] to [Disable].**

 **Note**

- Using a tripod is recommended.
- Taking test shots as in step 13 or even recording test time-lapse movies beforehand is recommended.
- The movie's field of view coverage for both the 4K and Full HD time-lapse movie recording is approx. 100%.
- To cancel time-lapse movie recording in progress, either press the shutter button completely or press the movie shooting button. The time-lapse movie shot so far will be recorded on the card.
- If the time required for recording is more than 24 hours but not more than 48 hours, "2 days" will be indicated. If three or more days are required, the number of days will be indicated in 24-hour increments.
- Even if the time-lapse movie's playback time is less than 1 sec., a movie file will still be created. In this case, [▶ 00'00"] is indicated as the playback time.
- If the shooting time is long, using the household power outlet accessories (sold separately) is recommended.
- YCbCr 4:2:0 (8-bit) color sampling and the BT.709 color space are used for 4K/Full HD time-lapse movies.

Caution

- Do not point the camera toward an intense light source, such as the sun or an intense artificial light source. Doing so may damage the image sensor or the camera's internal components.
- Time-lapse movies cannot be recorded when the camera is connected to a computer with the interface cable, or when an HDMI cable is connected.
- Movie Servo AF will not function.
- If the shutter speed is 1/30 sec. or slower, the exposure of the movie may not be displayed properly (may differ from that of the resulting movie).
- Do not zoom the lens during time-lapse movie recording. Zooming the lens may cause the image to be out of focus, the exposure to change, or the lens aberration correction not to function properly.
- Recording time-lapse movies under flickering light may cause noticeable screen flickering, and images may be captured with horizontal stripes (noise) or irregular exposure.
- Images displayed as time-lapse movies are recorded may look different from the resulting movie (in details such as inconsistent brightness from flickering light sources, or noise from a high ISO speed).
- When recording a time-lapse movie under low light, the image displayed during shooting may look different from what is actually recorded in the movie. In such cases, the **[Exp.SIM]** icon will blink.
- If you move the camera from left to right (panning) or shoot a moving subject during time-lapse movie recording, the image may look extremely distorted.
- During time-lapse movie recording, auto power off will not take effect. Also, you cannot adjust the shooting function and menu function settings, play back images, etc.
- Sound is not recorded for time-lapse movies.
- To start or stop time-lapse movie recording, you can press the shutter button completely, regardless of the **[Shutter btn function for movies]** setting.
- Significant changes in brightness between shots may prevent the camera from shooting at the specified interval when **[Interval]** is set to less than 3 sec. and **[Auto exposure]** is set to **[Each frame]**.
- If the shutter speed exceeds the shooting interval (such as for long exposures), or if a slow shutter speed is set automatically, the camera may not be able to shoot at the set interval. Shooting may also be prevented by shooting intervals nearly the same as the shutter speed.
- If the next scheduled shot is not possible, it will be skipped. This may shorten the recording time of the created time-lapse movie.
- If the time it takes to record to the card exceeds the shooting interval due to the shooting functions set or card performance, some of the shots may not be taken with the set intervals.
- The captured images are not recorded as still photos. Even if you cancel the time-lapse movie recording after only one shot is taken, it will be recorded as a movie file.

- Set [: **Time-lapse movie**] to [**Disable**] if you will connect the camera to a computer with the interface cable and use an application such as Camera Connect. Options other than [**Disable**] will prevent the camera from communicating with the computer.
- Image stabilization is not applied in time-lapse movie recording.
- Time-lapse movie shooting ends if the power switch is set to < **OFF** >, for example, and the setting is changed to [**Disable**].
- Even if a flash is used, it will not fire.
- The following operations cancel standby for time-lapse movie recording and switch the setting to [**Disable**].
 - Selecting either [**Clean now**] in [: **Sensor cleaning**] or [**Basic settings**] in [**Reset camera**]
 - Switching the shooting mode to [], [], or []
- Image quality may be lower if you start time-lapse movie recording while a white [] or red [] icon () is displayed. For best results, before recording, wait until the white [] or red [] icon is no longer displayed, which indicates that the camera has cooled down.
- With [**Auto exposure**] set to [**Each frame**], the ISO speed, shutter speed, and aperture value may not be recorded in the time-lapse movie Exif information in some shooting modes.

Note

- You can use Wireless Remote Control BR-E1 (sold separately) to start and stop time-lapse movie recording.

With Wireless Remote Control BR-E1

- First, pair Wireless Remote Control BR-E1 with the camera ()
- After you take some test shots and the camera is ready to shoot (as in step 14,) , set the release timing/movie shooting switch on the BR-E1 to <●> (immediate release) or <2> (2-sec. delay).
- If the remote control's switch has been set to < >, the time-lapse movie recording cannot start.

Camera Status/Remote Control Setting	<●> Immediate Release <2> 2-sec. Delay	< > Movie Recording
Test-recording screen	Test recording	To recording standby
Recording standby	Starts recording	To test-recording screen
During time-lapse movie recording	Ends recording	Ends recording

Approx. Time Available for Recording Time-Lapse Movies

For guidelines on how long you can record time-lapse movies (until the battery runs out), see [Movie recording](#).

Movie Self-Timer

Movie recording can be started by the self-timer.

1. Select [📷: Movie self-timer] (🔗).

2. Select an option.

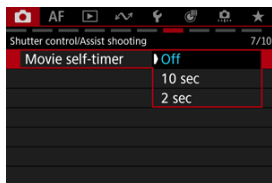

3. Record the movie.

- After you press the movie shooting button or tap [●], the camera beeps and displays the number of seconds left before recording.

Note

- To cancel the self-timer, either tap the screen or press < (SET) >.

The tally lamp lights up or blinks to indicate camera status.

1. Select [📷: Tally lamp] (🔗).

2. Select an option.

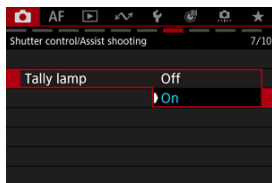

- When set to [On], the tally lamp lights up or blinks as follows.

Lit	Movie recording in progress
Blinking rapidly	<ul style="list-style-type: none">• Cannot record movies, due to a low battery level or insufficient card free space• High internal camera temperature, due to hot shooting conditions or extended movie recording
Blinking slowly	Movie recording is now possible for up to 6 min.

With pre-recording, automatic movie recording is already in progress a specified amount of time before you manually start recording.

This preliminary recording is referred to as pre-recording. The camera pre-records automatically during movie recording standby.

1. Select [📷: Pre-recording set.] (🔗).

2. Select [Pre-recording].

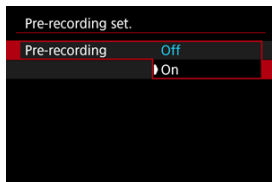

- Select [On].

3. Select [Recording time].

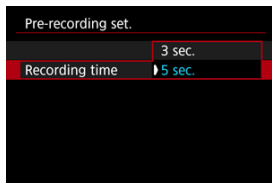





- Select the amount of time for pre-recording, before recording is started manually.

4. Record the movie.

- Record the movie in the same way as normal movie recording.
- Movies are recorded with the pre-recorded part added.

Caution

Restrictions during pre-recording

- The following items are not displayed on the movie recording screen.
 - Electronic level
 - Histogram
 - Some Quick Control settings (functionality is limited during pre-recording)
- Touch sounds are not played.
- The following operations and camera status pauses pre-recording. While pre-recording is paused, **[PRE  PRE ** blinks in the upper right of the movie recording screen.
 - Attaching or detaching a lens
 - Connecting via HDMI
 - Turning the Mode dial
 - Turning the camera off/on
 - Opening/closing the card slot cover
 - Low remaining battery level
 - High camera temperature
- **[ Standby: Low res.]** is set to **[Off]** and cannot be changed ().

**Note**

- Current information when recording begins is applied to movie Exif information.

Image Stabilizer (IS Mode)

[Movie Digital IS](#)

The camera's IS mode and movie digital IS features reduce camera shake as movies are recorded.

They can provide effective stabilization even when non-IS lenses are used.

With IS-equipped lenses, setting the lens Image Stabilizer switch to <ON> combines stabilization by the lens and camera.

1. Select [: IS (Image Stabilizer) mode] ().

2. Select [IS mode].

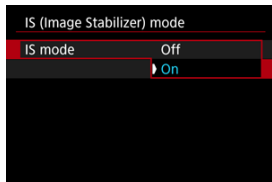

- Select [**On**] to use IS mode on the camera.

Movie Digital IS

1. Select [📷: IS (Image Stabilizer) mode] (🔗).

2. Select [📷 Digital IS].

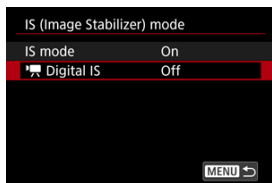

3. Select an option.

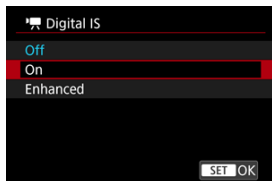

- **Off** (📷 Off)
Image stabilization with Movie digital IS is disabled.
- **On** (📷 On)
Camera shake will be corrected. The image will be slightly magnified.
- **Enhanced** (📷 Enhanced)
Compared to when [On] is set, stronger camera shake can be corrected. The image will be more magnified.

Caution

- Movie digital IS will not function when the lens's optical Image Stabilizer switch is set to < OFF >.
- With non-IS lenses, setting [ Digital IS] to [On] or [Enhanced] also sets [IS mode] to [On].
- Although movies can also be recorded with Movie digital IS when using RF-S or EF-S lenses or movie cropping, the image area is further reduced.
- Stabilization by Movie digital IS may be less effective at some movie recording sizes.
- The wider the angle of view (wide angle), the more effective the image stabilization will be. The narrower the angle of view (telephoto), the less effective the image stabilization will be.
- When using a tripod, setting Movie digital IS to [Off] is recommended.
- Depending on the subject and shooting conditions, the subject may blur noticeably (the subject momentarily looks out of focus) due to the effects of the Movie digital IS.
- Consider setting to [Off] when using a TS-E lens or fish-eye lens.
- Since Movie digital IS magnifies the image, the image looks more grainy. Noise, dots of light, etc. may also become noticeable.
- With the frame rate set to 239.76, 200.00, 119.88, or 100.00 fps, Movie digital IS may not provide sufficient stabilization when shooting with a macro lens near the closest focusing distance.

Note

- For details on configuring image stabilization for still photo shooting, see [Image Stabilizer \(IS Mode\)](#).
- With some lenses, even more effective stabilization (indicated by "+" next to the IS icon) is possible when the lens's IS is used in conjunction with [IS mode] and [Movie digital IS] on the camera. For details on lenses compatible with this feature, visit the Canon website ([🌐](#)).

Movie Auto Level

Auto leveling helps keep movies straight during recording.

⚠ Caution

- Set [📷 Digital IS] in [📷 IS (Image Stabilizer) mode] to [Off].

1. Select [📷 Auto level] (🔗).
2. Select an option.

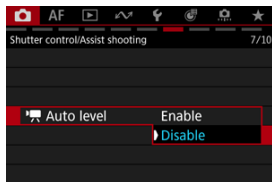

[False Color Display](#)

Color-coded display in six colors based on the brightness level is shown on the screen during movie recording. This can help you adjust the exposure.

1. Select [: False color set.] ().

2. Select [False color].

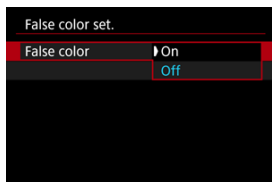

- Select [On].

3. Adjust the exposure as needed ().

- Adjust the exposure, referring to false color descriptions in [False Color Display](#) if necessary.

False Color Display





False color display is applied to images on the camera screen and viewfinder. You can also check false color display details in **[False color index]**.

Color	Meaning
Red	White clipping
Yellow	Just below white clipping
Pink	One stop over 18% gray
Green	18% gray
Blue	Just above black clipping
Purple	Black clipping
Neutral color	Brightness other than above

Caution

- Colors indicating the brightness level may change when the screen switches between recording standby and movie recording, and under some shooting settings.
- The following features are not available when the camera is set to use false colors.
 - Auto Lighting Optimizer
 - Zebra display
 - MF peaking
 - Dual Shooting (Still Photos and Movies)

Note

- With **[: HDMI display]** set to **[]**, false color display applies to external monitors connected via HDMI, and no image is displayed on the camera screen.
- With **[: HDMI display]** set to **[]**, false color display applies to the camera screen, and external monitors connected via HDMI show the actual image.

To simplify exposure adjustment before or during movie recording, you can display a striped pattern over or around image areas of a specified brightness.

1. Select [📷: Zebra settings] (🔗).

2. Select [Zebra].

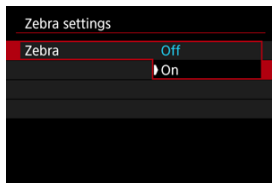

● Select [On].

3. Select [Zebra pattern].

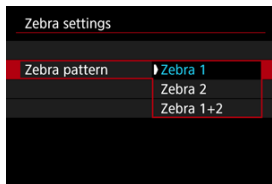

- [Zebra 1]: Displays left-slanting stripes around areas of the specified brightness.
- [Zebra 2]: Displays right-slanting stripes over areas that exceed the specified brightness.
- [Zebra 1+2]: Displays both [Zebra 1] and [Zebra 2]. [Zebra 1] display takes precedence where [Zebra 1] and [Zebra 2] display areas overlap.

4. Set the level.

Zebra 1 level

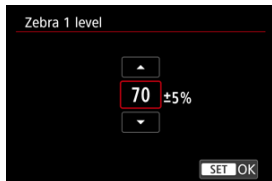



Zebra 2 level



- Turn the <  > dial to set it.

Note

- The maximum brightness value does not reach 100% when HDR-PQ is set. Note that the maximum brightness value varies depending on [: **Highlight tone priority**] and [: **Picture Style**] settings.
- The maximum brightness value does not reach 100% when the [: **Custom Picture**] gamma is set to [**Canon Log 2**] or [**Canon Log 3**].
- Checking the zebra display level in advance is recommended when you will set [**Zebra pattern**].

 [Waveform Setting](#)

 [Recording Emphasis](#)

 [Aspect Marker](#)

You can customize the details and screens of information shown on the screen or in the viewfinder during movie recording.



Note

- For details on the following topics, see [Shooting Information Display](#) for still photo shooting.
 - Customizing Information on the Screen
 - Customizing Information in the Viewfinder
 - Grid
 - Histogram
 - Electronic Level Size
 - Battery Level (%) Display
 - Card Free Space (%) Display
 - Lens Information Display
 - Clearing Settings

Waveform Setting

You can display a waveform monitor on the screen or in the viewfinder. It is displayed on external monitors during HDMI output.

1. Select [📷: Shooting info. disp.] (🔗).

2. Select [Waveform setting].

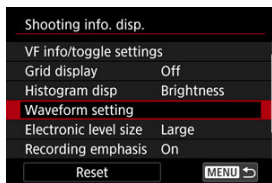

3. Set [Wave. monitor disp.] to [On].

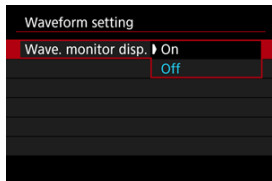

4. In [Type], select a waveform monitor option.

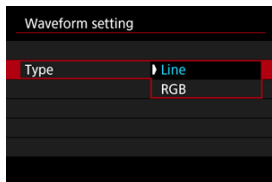



- **Line**
Displays a waveform of the entire image, with horizontal coordinates of the image on the horizontal axis and brightness values on the vertical axis.
- **RGB**
RGB parade display, with horizontal coordinates of the image on the horizontal axis and RGB brightness values on the vertical axis.

 **Caution**

- The waveform monitor is not displayed in [M/A] shooting mode.

 **Note**

- The waveform monitor is also shown on the screen for adjusting custom picture image quality.

1. Select [: Shooting info. disp.] ().
2. Select [Recording emphasis].

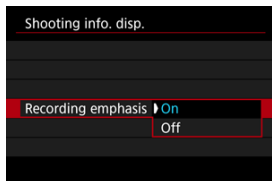

- **On**
The screen is outlined in red while movie recording is in progress.
- **Off**
No frame is displayed to call attention to recording in progress.

Aspect Marker

If you will change the image aspect ratio when editing the recorded movie, you can display aspect markers on the movie recording screen (during standby and recording) to be aware of the final angle of view after editing.

1. Select [: Shooting info. disp.] ().
2. Select [Aspect marker].

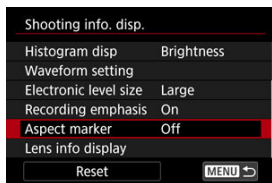

3. Select an option.

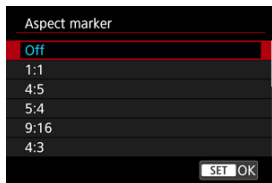

- Select a display option.

Note

- Markers are not shown during movie playback (recorded movies are not tagged with aspect marker information).

You can change the Quick Control (📷) views available during movie recording.

1. Select [📷: Quick Ctrl screen] (📷).

2. Select the view to display.

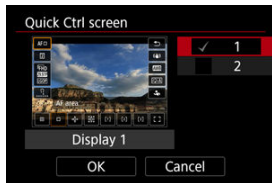

- Turn the <🌀> dial to select Quick Control display options.
- For items you prefer not to display, press <📷> to clear the checkmark [✓]. The [✓] mark cannot be cleared from all items at the same time.
- Select [OK] to register the setting.

Set to [On] to conserve battery power and control the rise of internal camera temperature during standby.

1. Select [📷: Standby: Low res.] (🔗).
2. Select an option.



⚠ Caution

- Image appearance during standby may differ from the appearance during movie recording, but this setting does not affect recording quality.
- Briefly when you start or stop recording movies, image display may remain on the current frame instead of being updated.

You can select the output range of video signals output via an HDMI connection.

1. Select [CAMERA: HDMI output range for C. Log] (CAMERA).

2. Select an option.



- **Prioritize Full Range**

Full-range output is used whenever possible. Note that the output range will be automatically adjusted to suit display specifications.

- **Narrow Range**

Narrow-range (video range) output is used.

Caution

- This setting is disabled when [CAMERA: HDMI RAW output] is set to [On].

- ✔ [Preparing to Embed XML Files](#)
- ✔ [Embedding XML Files](#)
- ✔ [Clearing Metadata Settings](#)
- ✔ [Checking Metadata Status](#)
- ✔ [Embedding Custom Picture Files](#)

Movie files can be embedded with metadata that conforms to the NewsML-G2 specification. Before you begin, the metadata to embed should be saved to a card.

Note

- Metadata can also be embedded using the Content Transfer Professional mobile app.
- Settings in  **Metadata** are disabled when metadata is embedded with Content Transfer Professional.

Preparing to Embed XML Files

1. **Save the XML file in the [XMLTAG] folder at the root level of the card.**
 - Create and save an XML file conforming to the NewsML-G2 specification.
 - When selecting an XML file to embed, you can select from up to 100 files.
2. **Load a card in card slot 2 (📁).**

1. Select [**☰**: Metadata] (**☰**).

2. Set [Add News Metadata] to [On].

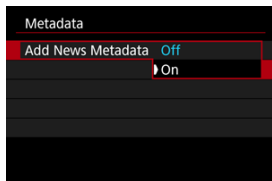

3. Select [News Metadata].

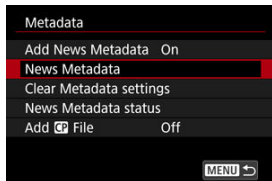

- This option is not available unless a card is loaded.

4. Select the metadata.

- Turn the <  > dial to make a selection.
- The first 8 characters of the XML file name are shown on the screen, along with a preview of the data itself.

5. Select [OK].

- The metadata is registered in the camera.

Clearing Metadata Settings

You can clear (delete) metadata registered to the camera.

1. Select [Clear Metadata settings].

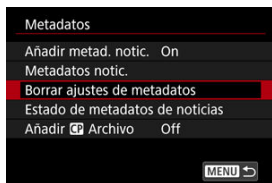

2. Select [OK].

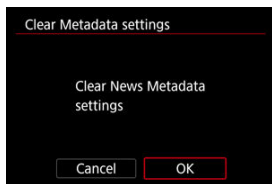

- Metadata registered to the camera is cleared.

Checking Metadata Status

You can review details of the metadata registered to the camera.

1. Select [Check News Metadata status].

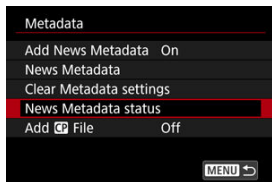

2. Check the details as needed.

Embedding Custom Picture Files

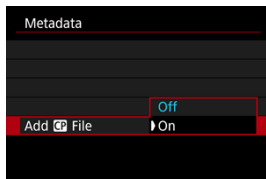

Custom picture files can be embedded in movie files by setting [Add CP File] to [On] when [CP function] in [CAM: Custom Picture] is set to [On].

Caution

- Custom picture files are not embedded in RAW movies.
- When you are recording both main and proxy movies, custom picture files are embedded in proxy movies if the main movies are RAW movies (RAW). If the main movies are XF-HEVC S or XF-AVC S movies (S), custom picture files are embedded in the main and proxy movie.

Time Code

- [Count Up](#)
- [Start Time Setting](#)
- [Movie Recording Count](#)
- [Movie Play Count](#)
- [HDMI](#)
- [Drop Frame](#)

Time codes record the time automatically as movies are recorded. Time codes always record elapsed hours, minutes, seconds, and frames. They are mainly used when movies are edited.

To set up the time code, use [: **Time code**].

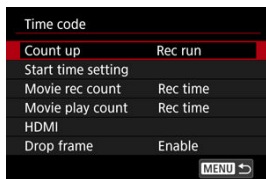

Caution

- Time codes may not be displayed correctly if your movies are played back on devices other than the camera.

Count Up

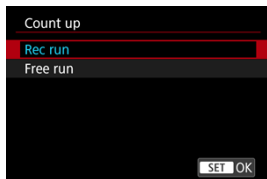

- **Rec run**
The time code advances only during movie recording. Time codes in each movie file recorded continue from the last time code in the previous file.
- **Free run**
The time code keeps advancing, even when you are not recording.

Caution

- When set to **[Free run]**, time codes are not added to High Frame Rate movies that you record.
- When set to **[Free run]**, time codes will be affected by any changes to settings for time, zone, or daylight saving time (🕒).

Start Time Setting

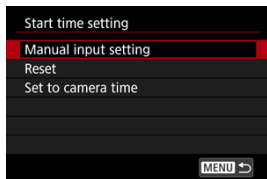

You can set the initial time of the time code.

- **Manual input setting**
Enables you to set any starting hour, minute, second, and frame.
- **Reset**
Resets the time set with **[Manual input setting]** or **[Set to camera time]** to "00:00:00." or "00:00:00:" (ⓐ).
- **Set to camera time**
Matches the hour, minute, and second set as the time on the camera. Sets the frame value to "00."

Movie Recording Count

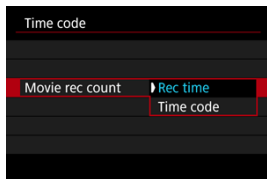

You can select how time is displayed on the movie recording screen.

- **Rec time**

During recording standby, displays the available recording time. During recording, displays the time that has elapsed since recording began (1).

- **Time code**

Displays the time code during movie recording (2).



Movie Play Count

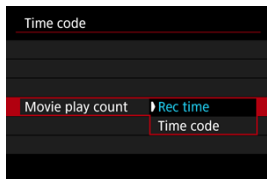

You can select how time is shown in basic information display on the movie playback screen.

- **Rec time**
Displays the recording or playback time during movie playback.
- **Time code**
Displays the time code during movie playback.



Note

- Time codes are always recorded to movie files (except when High Frame Rate movies are set to **[Free run]**), regardless of the **[Movie rec count]** setting.
- The **[Movie play count]** setting in **[CAMERA]: Time code** is linked to the **[PLAYBACK]: Movie play count**, so that these settings always match.
- The “frame” count is not displayed during recording.

Time code

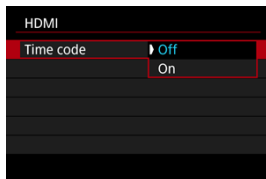

Time codes can be added to movies as you record them to an external device via HDMI.

- **Off**
No time code is added to HDMI video output.
- **On**
Time codes are added to HDMI video output. When [On] is set, [Rec Command] is displayed.

Rec Command

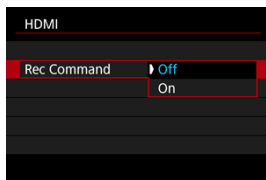

For HDMI video output recorded by an external device, you can synchronize recording to when you start and stop recording movies on the camera.

- **Off**
Recording is started and stopped by the external device.
- **On**
Recording by an external device is synchronized to starting/stopping recording on the camera.

 **Caution**

- Time codes are not added to HDMI video output when you record High Frame Rate movies with **[Count up]** in **[Time code]** set to **[Free run]**.
- To determine compatibility of external recording devices with **[Time code]** and **[Rec Command]** functions, check with the device manufacturer.
- Even with **[Time code]** set to **[Off]**, external recording devices may add time codes to movies, depending on their specifications. For details on device specifications relevant to adding time code to HDMI input, check with the device manufacturer.

Drop Frame

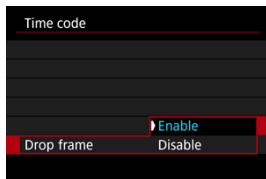

The time code's frame count will cause a discrepancy between the actual time and the time code if the frame rate is set to **239.8P** (239.76 fps), **119.9P** (119.88 fps), **59.94P** (59.94 fps), or **29.97P** (29.97 fps). You can choose whether to automatically compensate for this discrepancy.

- **Enable**

Corrects the discrepancy automatically by skipping time code numbers (DF: drop frame).

- **Disable**

The discrepancy is not corrected (NDF: non-drop frame).

Time codes are displayed as follows.

Enable	00:00:00. (Playback: 00:00:00.00)
Disable	00:00:00. (Playback: 00:00:00.00)

Note

- The **[Drop frame]** setting item is not displayed when the frame rate is set to **24.00P** (24.00 fps) or **23.98P** (23.98 fps), and when **[System frequency]** is set to **[50.00Hz:PAL]**.

Other Menu Functions

☑ [\[CAMERA\] Exposure](#) ☆

☑ [\[CAMERA\] Assist shooting/HDMI](#)

[CAMERA] Exposure



Exposure compensation

Exposure compensation is available in [P], [Tv], [Av], and [M] modes. For details on exposure compensation, see [Manual Exposure Compensation](#).

ISO speed settings

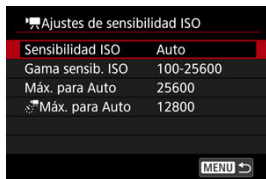

● ISO speed

In [M] mode, you can set the ISO speed manually. You can also select ISO Auto.

● ISO speed range

You can set the manual ISO speed setting range (minimum and maximum). ISO expansion can also be configured.

● Max for Auto

You can set the maximum limit for ISO Auto in movie recording in [P], [Tv], or [Av] mode or in [M] mode with ISO Auto.

● ☰ Max for Auto

You can set the maximum limit for ISO Auto in 4K time-lapse/Full HD time-lapse movie recording in [P], [Tv], or [Av] mode or in [M] mode with ISO Auto.

Av 1/8-stop incr.

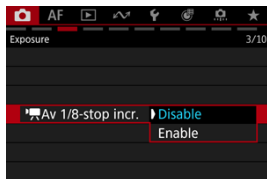



You can set aperture values on a finer scale when recording movies with RF or RF-S lenses.

This feature is available in [M] or [Av] recording mode.



Select [**Enable**] to change the aperture increment from 1/3 stop (or 1/2 stop) to 1/8 stop.

Caution

- [ Av 1/8-stop incr.] is not available (not displayed) when EF or EF-S lenses are used.
- When set to [**Enable**], setting options in [: **Exposure level increments**] are disabled and have no effect.

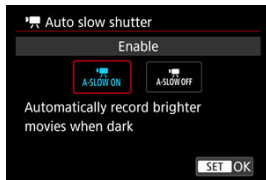
Auto slow shutter



You can choose whether to record movies that are brighter and less affected by image noise than when set to **[Disable]** by automatically slowing the shutter speed under low light. Available in  or  recording mode. Applies when the frame rate of the movie recording size is **59.94P** or **50.00P**.

- **Disable**

Enables you to record movies with smoother, more natural movement, less affected by subject shake than when set to **[Enable]**. Note that under low light, movies may be darker than when set to **[Enable]**.

- **Enable**

Enables you to record brighter movies than when set to **[Disable]** by automatically reducing the shutter speed to 1/30 sec. (NTSC) or 1/25 sec. (PAL) under low light.

Note

- Setting to **[Disable]** is recommended when recording moving subjects under low light, or when afterimages such as trails may occur.

Shutdown warning guidance

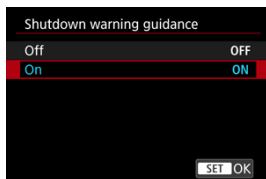

Shutdown warning guidance (about auto shutdown during movie recording due to high internal temperature under certain movie recording settings) can be displayed on startup. If you prefer not to display shutdown warning guidance, set [CAMERA]: **Shutdown warning guidance** to [Off].

HDMI display

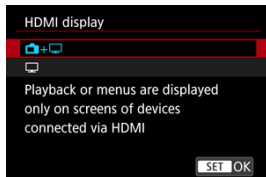

You can specify how movies are displayed as they are recorded via HDMI to an external device. Movie output itself corresponds to the : **Movie rec. size** setting. The default setting is .

- Enables movie display both on the camera screen and on the other device, via HDMI output. Camera operations such as image playback or menu display are shown on the other device via HDMI, not on the camera screen.
- Deactivates the camera screen during output via HDMI, so that the screen is blank. Shooting information, AF points, and other information is included in HDMI output and shown on any monitors connected to the external recording device, but you can stop output of this information by pressing the < INFO > button. Before recording movies externally, confirm that no information is being sent by the camera by making sure no shooting information, AF points, and so on is displayed on external monitors or other devices. Settings such as time codes may not be recorded correctly in external movie recording with : **Standby: Low res.** set to **[On]**.

? For longer HDMI output

To continue HDMI output for longer than 30 min., select , then set **[Auto power off]** in : **Power saving** to **[Disable]** . HDMI output will continue after the camera screen turns off when the time set in **[Screen off]** elapses.

 **Caution**

- HDMI output without information prevents display of warnings about the card space, battery level, or high internal temperature (🔒) via HDMI.
- During HDMI output, display of the next image may take some time if you switch between movies of different recording qualities or frame rates.
- Avoid operating the camera when recording movies to external devices, which may cause information to be displayed in the HDMI video output.
- Brightness and color of movies recorded with the camera may look different from that of HDMI video output recorded by external devices, depending on the viewing environment.

 **Note**

- By pressing the <INFO> button, you can change the information displayed.
- Time codes can be added to HDMI video output (🔒).
- Audio is also output via HDMI, except when **[Sound recording]** is set to **[Disable]**.

HDMI RAW output☆

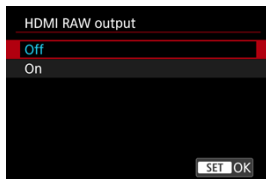

Set to **[On]** for RAW movie output at resolutions up to 8K from the HDMI terminal to compatible devices.

As recording begins, movies are also recorded to card **[2]** (if it is in the camera) in XF-AVC format.

You can restrict recording to external recording devices when card **[2]** is not inserted by setting **[Rec Command]** to **[On]** **(☑)**.

Set the movie recording quality in **[📷: Movie rec. size]** **(☑)**.

Caution

- Movies will not be displayed correctly unless the connected device is compatible with the camera's HDMI RAW output.
- [HDMI RAW output] is not available in [A+] mode.
- When HDMI RAW output is set, [CP function] in [CAM: Custom Picture] is locked to [On].
- Image display on external recording devices conforms to the device settings and differs from display on the camera.
- Movies recorded to card [2] conform to the image settings configured on the camera.
- Some restrictions apply to the following features when the camera is set to HDMI RAW output.
 - [ISO speed settings] on the [CAM] tab
 - [Record func+card/folder sel.] on the [CAM] tab
- The following features are not available when the camera is set to HDMI RAW output.
 - High Frame Rate movies
 - [H]HDR shooting (PQ)
 - Auto Lighting Optimizer
 - Highlight Tone Priority
 - Picture Style
 - Clarity
 - Pre-recording setting
 - Movie digital IS
 - HDMI display
 - HDMI resolution
 - Canon Log HDMI Output Range
 - Magnified image display

Note

- You can include time code in output to devices compatible with RAW movies by setting [Time code] in the [CAM: Time code] [HDMI] setting to [On]. With [Rec Command] set to [On], you can also control starting and stopping of movie recording on devices compatible with RAW movies by starting and stopping movie recording on the camera (CAM).

General Movie Recording Precautions

[✔ Guidance Display Before Recording](#)

[✔ Warning Indicator Display in Movie Recording](#)

Guidance Display Before Recording

Shutdown warning guidance may be displayed when the camera starts up, after settings are adjusted, or in other situations (✔).



The guidance warns that the camera may become hot internally if movies are recorded under the current settings, and that if you continue recording, the camera may turn off automatically.

If you will record over an extended period, consider changing the setting indicated by the guidance (movie recording size), so that you can record without the camera displaying guidance.

If you prefer to record without changing the settings, note any warning indicators displayed as you record.

Warning Indicator Display in Movie Recording

A 10-level indicator (1) is displayed during movie recording in case of excessive internal camera temperature.

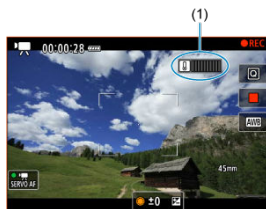

As the internal temperature rises, the level on the indicator extends to the right. How fast the level increases will depend on shooting conditions. Levels 1–7 are marked in white, but once the temperature reaches level 8, the color changes.



[REC] flashes in red if you continue recording after the indicator reaches level 9, marked in orange. A flashing icon indicates that the camera will soon turn off automatically.



A message is displayed if you continue to record while the icon is flashing, and the camera automatically turns off.







● Subsequent recording

To keep recording under the same settings, leave the camera off and let it cool down a while. Note that the camera may overheat again after you resume recording.

Precautions for movie recording

- Do not point the camera toward an intense light source, such as the sun or an intense artificial light source. Doing so may damage the image sensor or the camera's internal components.
- If you record something that has fine detail, moire or false colors may result.
- If [AWB] or [AWBW] is set and the ISO speed or aperture value changes during movie recording, the white balance may also change.
- If you record a movie under fluorescent or LED lighting, the movie image may flicker.
- If you perform AF with a USM lens during movie recording in low light, horizontal banding noise may be recorded in the movie. The same type of noise may occur if you focus manually with certain lenses equipped with an electronic focusing ring.
- Recording a few test movies is recommended if you intend to perform zooming during movie recording. Zooming as you record movies may cause exposure changes or lens sounds to be recorded, an uneven audio level, inaccurate lens aberration correction, or loss of focus.
- Large aperture values may delay or prevent accurate focusing.
- Performing AF during movie recording may cause the following kinds of issues: significant temporary loss of focus, recording of changes in movie brightness, temporary stopping of movie recording, or recording of mechanical lens sounds.
- Avoid covering the built-in microphones with your fingers or other objects.
- Connecting or disconnecting an HDMI cable during movie recording will end recording.
- If necessary, also see [General Still Photo Shooting Precautions](#).
- The camera may become hot in movie recording while connected via Wi-Fi. Use a tripod or take other measures to avoid handheld recording.
- Image quality may be lower when recording movies under a combination of conditions such as high ISO speeds, high temperatures, low shutter speeds, and low light.
- Recording movies over an extended period may cause the camera's internal temperature to rise and affect image quality. Turn off the camera when possible if you are not recording movies.

and display

-  may be displayed in hot environments or when factors such recording movies or displaying images on the screen over extended periods increase the camera's internal temperature. If this condition continues, a red  icon will be displayed. Note that the time until a red  appears after the  icon varies depending on shooting conditions.
- The  icon with red indicates that movie recording will soon be terminated automatically. Note that the time until movie recording stops automatically when the red  icon is displayed varies depending on shooting conditions.
- Red  display indicates that movie recording will soon stop automatically, so turn the camera off or take other measures, and wait until it cools down. Moreover, when you are not shooting or recording, always turn off the camera.
- After movie recording automatically stops, you will be unable to record movies or shoot still photos until the camera has cooled down.

Recording and image quality

- If the attached lens has an Image Stabilizer and you set the Image Stabilizer switch to **< ON >**, the Image Stabilizer will operate at all times even if you do not press the shutter button halfway. This will consume battery power, and it may reduce the total movie recording time. When the Image Stabilizer is not necessary, such as when using a tripod, it is recommended that you set the Image Stabilizer switch to **< OFF >**.
- If the brightness changes as you record a movie with auto exposure, the movie may appear to stop momentarily. In this case, record movies with manual exposure.
- If there is a very bright light source in the image, the bright area may appear black on the screen. Movies are recorded almost exactly as they appear on the screen.
- Image noise or irregular colors may occur when recording at high ISO speeds, high temperatures, slow shutter speeds, or under low light.
- Video and audio quality of recorded movies may be worse on other devices, and playback may not be possible, even if the devices support XF-HEVC/XF-AVC formats.
- If you use a card with a slow writing speed, an indicator may appear on the right of the screen during movie recording. The indicator shows how much data has not yet been written to the card (remaining capacity of the internal buffer memory), and it increases more quickly the slower the card is. If the indicator (2) becomes full, movie recording will stop automatically.



(2)

- If the card has a fast writing speed, the indicator will not appear or the level (if displayed) will not increase much. First, record a few test movies to see if the card can write fast enough.
- If the indicator shows that the card is full, and movie recording stops automatically, the sound near the end of the movie may not be recorded properly.
- If the card's writing speed is slow (due to fragmentation) and the indicator appears, formatting the card may make the writing speed faster.
- Banding or noise may be noticeable in dark image areas, depending on [📷: Custom Picture], [📷: 📷: HDR shooting (PQ)], [📷: Highlight tone priority], or [📷: HDMI RAW output] settings, due to the effect of settings that determine the dynamic range, gamma curve, and similar details. Record a few test movies and check the results in advance.
- Image quality may improve if you change the ISO speed or the [📷: High ISO speed NR] or [Shadow comp.] settings, or, in post-production, perform color grading.

Audio restrictions

- The following restrictions apply in [AF] mode.
 - Sound will not be recorded for approx. the last two frames.
 - When you play back movies in Windows, movie images and sound may become slightly out of synchronization.



Note

Notes for movie recording

- Each time you record a movie, a new movie file is created on the card.
- Field of view (coverage) is approx. 100%.
- Focusing is also possible by pressing the < AF-ON > button.
- To enable starting/stopping movie recording by pressing the shutter button completely, set [Fully-press] for [Shutter btn function for movies] to [Start/stop mov rec] (☑).
- Focus preset during movie recording is available when using (super) telephoto lenses equipped with this function released in and after the second half of 2011.
- For details on using built-in or external microphones, see [Sound Recording](#).

AF/Drive

This chapter describes autofocus operation and drive modes and introduces menu settings on the AF [**AF**] tab.

☆ to the right of titles indicates functions only available in [**Fv**], [**P**], [**Tv**], [**Av**], [**M**], or [**BULB**] mode.

Note

- < **AF** > stands for autofocus. < **MF** > stands for manual focus.

- [Tab Menus: AF \(Still Photos\)](#)
- [Tab Menus: AF \(Movie Recording\)](#)
- [AF Operation](#) ☆
- [Movie Servo AF](#)
- [Selecting the AF Area](#)
- [Manual Focus](#)
- [Registering People to Prioritize](#) ☆
- [Servo AF Characteristics](#) ☆
- [Customizing AF Functions](#)
- [Focus Preset](#)
- [Selecting the Drive Mode](#)
- [Using the Self-Timer](#)
- [Remote Control Shooting](#)

Tab Menus: AF (Still Photos)

● AF operation/area

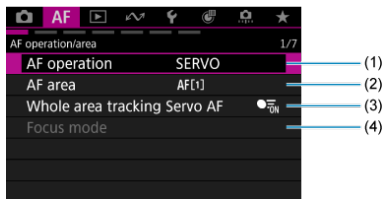

- (1) [AF operation](#) ☆
- (2) [AF area](#) ☆
- (3) [Whole area tracking Servo AF](#) ☆
- (4) [Focus mode](#)

Note

- When lenses without a focus mode switch are used, **[Focus mode]** is displayed on the **[AF1]** tab.

● Subject detection

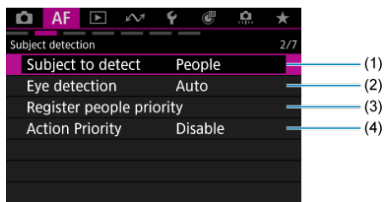

- (1) [Subject to detect](#) ☆
- (2) [Eye detection](#)
- (3) [Register people priority](#) ☆
- (4) [Action Priority](#) ☆

● Servo AF character.

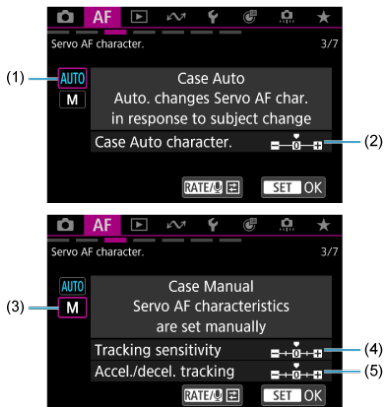

- (1) [Case Auto](#) ☆
- (2) [Case Auto character.](#) ☆
- (3) [Case Manual](#) ☆
- (4) [Tracking sensitivity](#) ☆
- (5) [Accel./decel. tracking](#) ☆

● Customize AF operation

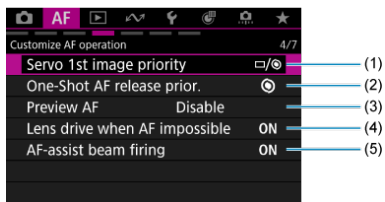

- (1) [Servo 1st image priority](#) ☆
- (2) [One-Shot AF release prior.](#) ☆
- (3) [Preview AF](#)
- (4) [Lens drive when AF impossible](#) ☆
- (5) [AF-assist beam firing](#)

● Customized controls

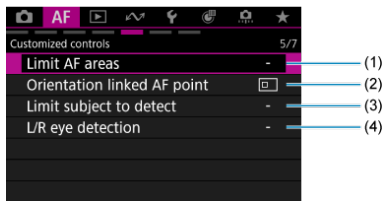

- (1) [Limit AF areas](#) ☆
- (2) [Orientation linked AF point](#) ☆
- (3) [Limit subject to detect](#) ☆
- (4) [L/R eye detection](#) ☆

● MF related

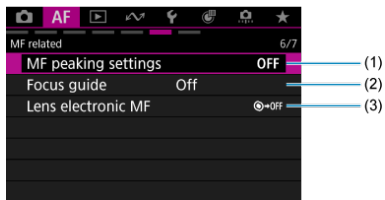

- (1) [MF peaking settings](#) ☆
- (2) [Focus guide](#)
- (3) [Lens electronic MF](#) ☆

● Various settings/Various settings

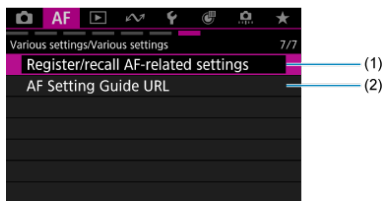

(1) [Register/recall AF-related settings](#) ☆

(2) [AF Setting Guide URL](#) ☆

Tab Menus: AF (Movie Recording)

● AF operation/area

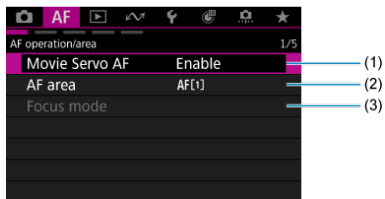

- (1) [Movie Servo AF](#)
- (2) [AF area](#) ☆
- (3) [Focus mode](#)

Note

- When lenses without a focus mode switch are used, [**Focus mode**] is displayed on the [**AF1**] tab.

● Subject detection

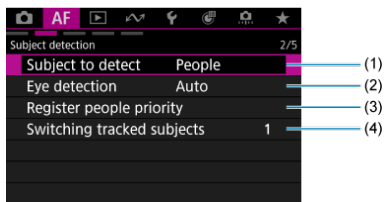

- (1) [Subject to detect](#) ☆
- (2) [Eye detection](#)
- (3) [Register people priority](#) ☆
- (4) [Switching tracked subjects](#) ☆

● **Servo AF character.**

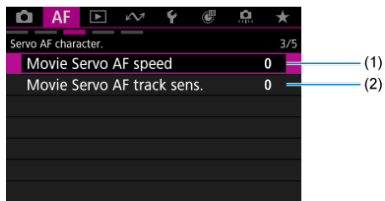

- (1) [Movie Servo AF speed](#) ☆
- (2) [Movie Servo AF track sens.](#) ☆

● **Customize AF operation/Customized controls**

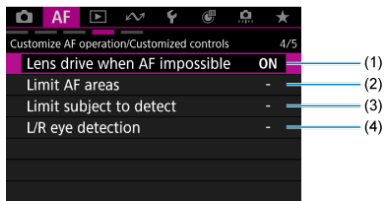

- (1) [Lens drive when AF impossible](#) ☆
- (2) [Limit AF areas](#) ☆
- (3) [Limit subject to detect](#) ☆
- (4) [L/R eye detection](#) ☆

● MF related

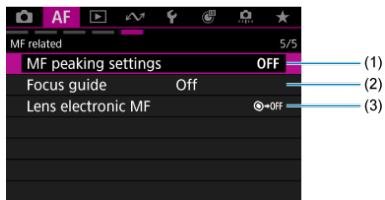

(1) [MF peaking settings](#) ☆

(2) [Focus guide](#)

(3) [Lens electronic MF](#) ☆

- ☑ [One-Shot AF for Still Subjects](#)
- ☑ [Servo AF for Moving Subjects](#)
- ☑ [AI Focus AF for Automatic AF Mode Switching](#)

You can select the AF operation characteristics to suit the shooting conditions or subject.

1. Set the focus mode to AF.

- **For RF lenses with a focus mode switch**
Set the lens's focus mode switch to <AF>.

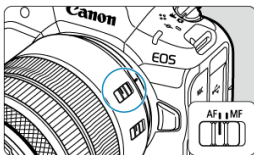

- **For RF lenses without a focus mode switch**
Set [**AF**: Focus mode] to [AF].

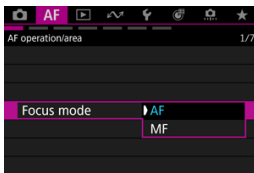

2. Select [**AF**: AF operation] (☑).

3. Select an option.

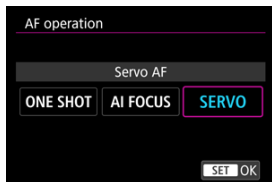

Note

- If focus is not achieved, the AF point will turn orange. With One-Shot AF, shooting is not possible even by pressing the shutter button completely. Recompose the shot and try to focus again. Or, see [Shooting Conditions That Make Focusing Difficult](#).
- With Servo AF, the camera shoots even when subjects are not in focus.

One-Shot AF for Still Subjects

This AF operation is suited for still subjects. When you press the shutter button halfway, the camera will focus only once.

- When focus is achieved, the AF point will turn green and the beeper will sound.
- The focus remains locked while you hold down the shutter button halfway, allowing you to recompose the image before taking the picture.
- For details on the continuous shooting speed for continuous shooting, see [Selecting the Drive Mode](#).

Note

- If [**B**: Beep] is set to [Disable], the beeper will not sound when focus is achieved.
- See [Lens electronic MF](#) when using a lens that supports electronic manual focusing.

Shooting with the focus locked

When shooting with the focus locked, you can focus with One-Shot AF before recomposing the shot and shooting.

1. Aim the AF point over a subject to focus on, then press the shutter button halfway.



2. After the subject is in focus, keep the shutter button pressed halfway and recompose the shot.



3. Press the shutter button completely to take the picture.

Servo AF for Moving Subjects

This AF operation is suited for moving subjects. While you hold down the shutter button halfway, the camera will keep focusing on the subject continuously.

- When focus is achieved, the AF point will turn blue. The beeper will not sound even when focus is achieved.
- The exposure is set at the moment the picture is taken.
- For details on the continuous shooting speed for continuous shooting, see [Selecting the Drive Mode](#).
- In **[A+]** mode, by default, the camera automatically switches to Servo AF in response to subject movement.

Caution

- Accurate focusing may not be possible at high aperture values or depending on the lens, the distance to the subject, and how fast the subject is moving.
- Zooming during continuous shooting may throw off the focus. Zoom first, then recompose and shoot.
- Consider shooting with One-Shot AF if Servo AF operation is unsteady for still subjects.

AI Focus AF for Automatic AF Mode Switching

The AF mode is automatically switched from [**One-Shot AF**] to [**Servo AF**] based on subject status while you are pressing the shutter button halfway or shooting continuously.

Movie Servo AF

[Subject Detection AF](#)

With this function enabled, the camera keeps focusing on the subject during movie recording.

1. Set the still photo shooting/movie recording switch to .

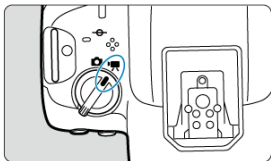

2. Select **[AF: Movie Servo AF]** .
3. Select **[Movie Servo AF]**.

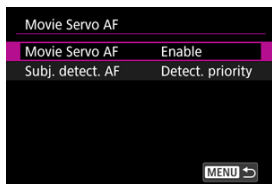

4. Select an option.

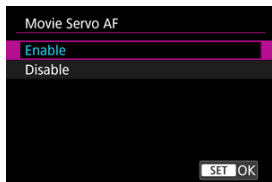

● Enable

- The camera focuses on the subject continuously even when you are not pressing the shutter button halfway.
- To keep the focus at a specific position, or if you prefer not to record mechanical sounds from the lens, you can temporarily stop Movie Servo AF by tapping [**Movie Servo AF paused**] (1) in the lower left of the screen.



(1)

- Movie Servo AF will resume if you return to movie recording after operations such as pressing the < MENU > or < ▶ > button or changing the AF area.

● Disable

While you hold down the shutter button halfway, the camera will keep focusing on the subject continuously. Pressing the < AF-ON > button focuses only once.

 **Caution**

Precautions when set to [Movie Servo AF: Enable]

- **Shooting conditions that make focusing difficult**
 - A fast-moving subject approaching or moving away from the camera.
 - A subject moving at a close distance to the camera.
 - When shooting with a higher aperture value.
 - Also see [Shooting Conditions That Make Focusing Difficult](#).
- Since the lens is driven continuously and the battery power is consumed, the possible movie recording time (🕒) will be shortened.
- The camera's built-in microphone may also record mechanical sounds of the lens or sounds of camera/lens operations if AF operations are performed or the camera or lens is operated during movie recording. In this case, using an external microphone may reduce these sounds. If the sounds are still distracting with an external microphone, it may be more effective to remove the external microphone from the camera and position it away from the camera and lens.
- Movie Servo AF pauses during magnified view.
- During movie recording, if a subject approaches or moves away or if the camera is moved vertically or horizontally (panning), the recorded image may momentarily expand or contract (change in image magnification).

Subject Detection AF

You can specify whether to use Movie Servo AF if the subject set in [**AF: Subject to detect**] (🔗) is not detected.

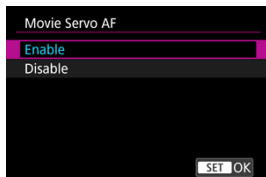

- **Detect. priority**

Movie Servo AF is used for automatically selected subjects within the area set in [**AF: AF area**] (🔗).

Subjects set in [**AF: Subject to detect**] are prioritized for automatic selection.

- **Detect. only**

Movie Servo AF is only used for subjects set in [**AF: Subject to detect**]. Movie Servo AF stops if no subject is detected.

Selecting the AF Area

- [AF Area](#)
- [Selecting the AF Area](#)☆
- [Whole Area Tracking Servo AF](#)☆
- [Subject to Detect](#)☆
- [Eye Detection](#)
- [Action Priority](#)☆
- [Tracking with a Button](#)
- [Manually Setting AF Points or Zone AF Frames](#)
- [Adjusting the Zone AF Frame Size](#)
- [Registering AF Points \(Home Position\)](#)
- [Magnified View](#)
- [AF Shooting Tips](#)
- [Shooting Conditions That Make Focusing Difficult](#)
- [AF Range](#)

AF Area



This section describes AF area operation with [**AF: Whole area tracking Servo AF**] set to [**Off**].

- Select the AF area by pressing the <M-Fn> button.
- You can switch [**AF: Whole area tracking Servo AF**] [**On**] or [**Off**] by pressing the <INFO> button.
- Servo AF for [□], [□], [□], or [□] tracks subjects with [**AF: Whole area tracking Servo AF**] set to [**Off**] and [**AF: Subject to detect**] set to [**None**].

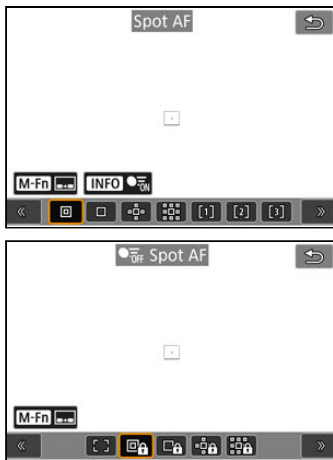
[□]: Spot AF / [□]:  Spot AF



The camera focuses in a narrower area than 1-point AF.

: 1-point AF / :  OFF 1-point AF

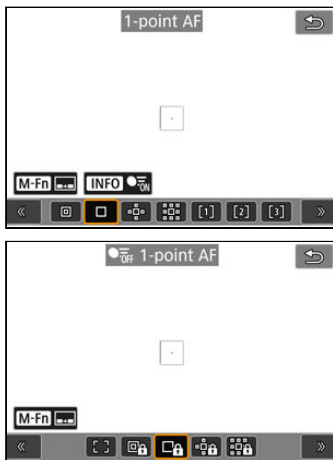

The camera focuses using a single AF point [].

☰☰: Expand AF area: ☰☰ / ☰☰: ☰☰ OFF Expand AF area: ☰☰

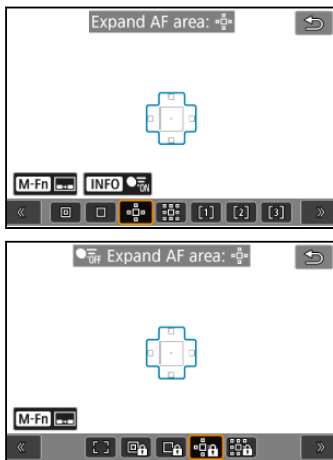





Focuses using one AF point (☰) and the AF area outlined here in blue. Effective for moving subjects, which are difficult to track with 1-point AF.

Focusing on your preferred subject is easier than with Flexible Zone AF.

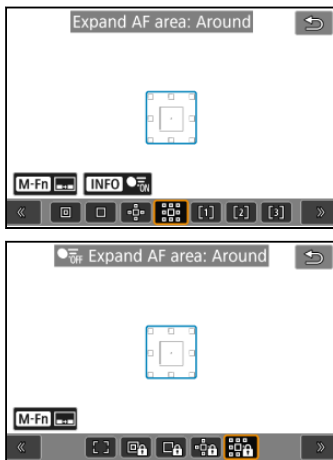
When Servo AF is used, first you will focus using an AF point (☰).

 Expand AF area: Around /  OFF  Expand AF area: Around



Focuses using one AF point  and the surrounding AF area outlined here in blue, which makes it easier to focus on moving subjects than with Expand AF area: . When Servo AF is used, first you will focus using an AF point .

[1]: Flexible Zone AF 1 (default)

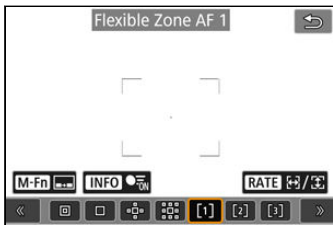

With Flexible Zone AF 1, you can freely set the size of the Zone AF frame [] (). Uses auto selection AF in Zone AF frames to cover a larger area than Expand AF area, which makes focusing easier than with 1-point AF/Expand AF area and effective for moving subjects.

By default, a square Zone AF frame is set.

Focusing areas are determined not only based on the nearest subject but also based on a variety of other conditions such as faces (of people or animals), vehicles, subject motion, and subject distance.

Pressing the shutter button halfway displays [] over AF points in focus.

[2]: Flexible Zone AF 2

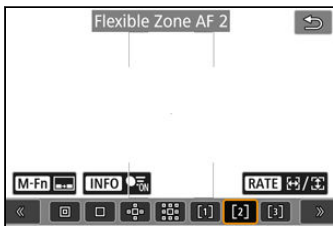

With Flexible Zone AF 2, you can freely set the size of the Zone AF frame [] (). Uses auto selection AF in Zone AF frames to cover a larger area than Expand AF area, which makes focusing easier than with 1-point AF/Expand AF area and effective for moving subjects.

By default, a vertical rectangular Zone AF frame is set.

Focusing areas are determined not only based on the nearest subject but also based on a variety of other conditions such as faces (of people or animals), vehicles, subject motion, and subject distance.

Pressing the shutter button halfway displays [] over AF points in focus.

[3]: Flexible Zone AF 3

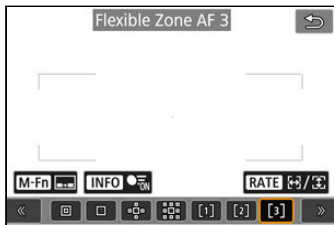

With Flexible Zone AF 3, you can freely set the size of the Zone AF frame [] (). Uses auto selection AF in Zone AF frames to cover a larger area than Expand AF area, which makes focusing easier than with 1-point AF/Expand AF area and effective for moving subjects.

By default, a horizontal rectangular Zone AF frame is set.

Focusing areas are determined not only based on the nearest subject but also based on a variety of other conditions such as faces (of people or animals), vehicles, subject motion, and subject distance.

Pressing the shutter button halfway displays [] over AF points in focus.

[]: Whole area AF

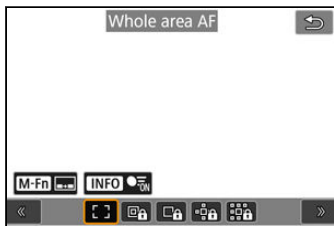

Uses auto selection AF in a whole-area AF frame to cover a larger area than Flexible Zone AF, which makes focusing easier than with 1-point AF/Expand AF area/Flexible Zone AF and effective for moving subjects.

Focusing areas are determined not only based on the nearest subject but also based on a variety of other conditions such as faces (of people or animals), vehicles, subject motion, and subject distance.

Pressing the shutter button halfway displays [] over AF points in focus.

You can select the AF area to suit the shooting conditions or subject.
If you prefer to focus manually, see [Manual Focus](#).

1. Select [**AF**: AF area] (,).

2. Select the AF area.

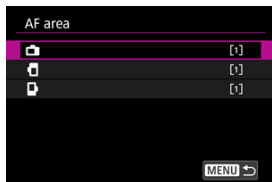
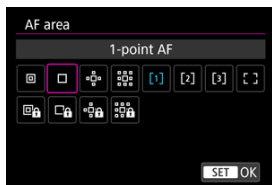

- The screen above is displayed when [**AF**: Orientation linked AF point] () is set to [**Separate AF pts: Area+pt**]. Set separate AF areas after choosing vertical and horizontal orientations.

Note

- To set the AF area, you can also press the < > button and then the < M-Fn > button.
- The following descriptions apply to the camera with AF operation set to [**Servo AF**] (). Once a subject is in focus with [**One-Shot AF**] (), the AF point turns green.

You can set whether to switch to whole-area subject tracking during Servo AF (while the shutter button is pressed halfway with **[AF: AF operation]** set to **[Servo AF]**).

1. Select **[AF: Whole area tracking Servo AF]** (🔗).
2. Select an option.

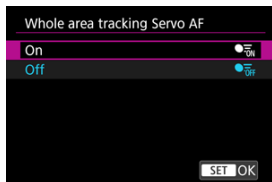

- **On**
The AF area switches to whole-area AF to track subjects across the entire screen area while the shutter button is pressed halfway.
- **Off**
Subjects are tracked only within AF points when the shutter button is pressed halfway or completely.

You can specify conditions for automatic selection of the main subject to track.

Selecting an option other than **[None]** will display a tracking frame [] for the main subject detected. The tracking frame will move to track subjects that start moving.

You can shoot with the subject's eyes in focus by setting **[AF: Eye detection]** to an option other than **[Disable]** ().

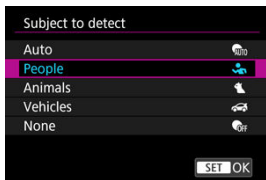

● Auto

Automatic selection of the main subject to track from any people, animals, or vehicles in the scene.

● People

Detects people and prioritizes detection results for people as the main subjects to track. Detection targets human faces, heads, or bodies, and tracking frames are shown over any face or head detected.

When human faces, heads, or bodies cannot be detected, the camera may track other parts of their body.

● Animals

Detects animals (dogs, cats, birds, or horses) and people, with animal detection results given priority to determine main subjects to track.

For animals, the camera attempts to detect faces or bodies, and a tracking frame is shown over any face detected.

When an animal's face or entire body cannot be detected, the camera may track part of their body.

● Vehicles

Detects vehicles (sports cars and motorcycles, aircraft, and trains) and people, with vehicle detection results given priority to determine main subjects to track.

For vehicles, the camera attempts to detect key details or the entire vehicle (or for trains, the front part), and a tracking frame is shown over any of these details detected.

When key details or the entire vehicle cannot be detected, the camera may track other parts of the vehicle.

Press the < INFO > button to enable or disable Spot detection for key details of vehicles.

- **None**

The camera determines the main subject automatically from how you compose shots, without detecting subjects.

Tracking frames are not displayed.

 **Caution**

- The following kinds of subjects may not be detected.
 - Extremely small or large
 - Too bright or dark
 - Partially hidden
 - Difficult to distinguish from the background
 - Obscured by rain, snow, or dust clouds
- People's posture or the color or shape of what they are wearing may prevent detection. Tracking frames may also appear for subjects other than people.
- The camera may not detect dogs, cats, birds, or horses, depending on the breed, color, shape, or posture. Tracking frames may also appear for similar-looking animals or non-animal subjects.
- The camera may not detect two- or four-wheeled vehicles, aircraft, or trains, depending on the type, color, shape, or orientation. Tracking frames may also appear for similar-looking vehicles or subjects that are not vehicles.

 **Note**

- When pressing the shutter button halfway for subject selection, you can choose the following subjects. In scenes without relevant subjects, the camera tracks other objects regardless of the [**AF: Subject to detect**] setting.
 - **Auto**
People, animals, vehicles
 - **People**
People
 - **Animals**
Animals, people
 - **Vehicles**
Vehicles, people
- In [**AF: Limit subject to detect**], you can limit the available detection setting options to your preferred options.
- If it seems difficult for the camera to detect your preferred subject when you are shooting people, animals, or vehicles with [Auto], it may be easier if you switch to the setting option specifically for that subject.
- To restrict AF to your specified AF area, set [**AF: Whole area tracking Servo AF**] to [Off] and [**AF: Subject to detect**] to [None].

Manually selecting a subject for focus

1. Check the tracking frame.





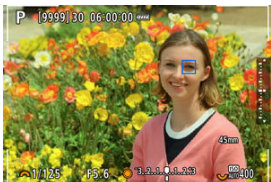
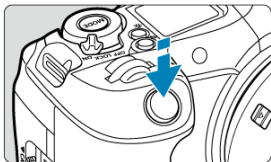

- Aim the camera at the subject. An AF point (or Zone AF frame) appears on the screen if you have set [**AF**: **AF area**] to an option other than [**Whole area AF**]. In this case, aim the AF point over the subject.
- A tracking frame [] appears over any subjects detected.
- Tracking frames [] away from AF points are displayed in gray, except in some cases.
- Once the tracked subject is near an AF point, even if it is outside the AF point, the tracking frame turns white (distinguishing it as an active frame), which enables selection as the main subject.
- Gray display of tracking frames [] does not apply in movie recording.

2. Focus and shoot/record.



- A tracking frame is displayed (in green for One-Shot AF or blue for Servo AF) when you press the shutter button halfway, and the camera beeps (only for One-Shot AF). An orange tracking frame indicates that the camera could not focus on subjects.

Note

- Selecting a subject by touch with **[AF: AF area]** set to **[Whole area AF]** changes the tracking frame to  and locks on to that subject for tracking across the entire screen.
- To release locked tracking, tap  OFF.
- Pressing the shutter button halfway when the AF point does not overlap the tracking frame  will focus using the AF point.
- The active  may cover part of the subject instead of the entire subject.
- The size of tracking frames varies depending on the subject.
- Even if you have manually selected an AF area, you can switch the AF area to **[Whole area AF]** and start AF with subject detection by pressing the button assigned to **[AF on detected subject]** in : **Customize buttons for shooting**.

 **Caution**

- In still photo shooting, tapping the screen to focus will focus with **[One-Shot AF]**, regardless of the AF operation setting.
- If the subject's face is significantly out of focus, face detection will not be possible. Adjust the focus manually () so that the face can be detected, then perform AF.
- AF may not detect subjects or people's faces at the edges of the screen. Recompose the shot to center the subject or bring the subject closer to the center.

Eye Detection

You can shoot with the eyes of people or animals in focus.

1. Select [**AF: Eye detection**] (👁️, 👁️).
2. Select an option.

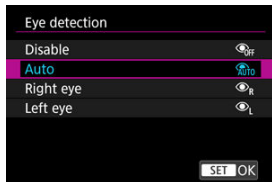

- **Disable**
Eye detection is not performed.
- **Auto**
The eye for AF operation is selected automatically after eye detection.
- **Right eye/Left eye**
Gives priority to the selected eye for AF, after eye detection. If the eye on the side with priority is not detected, the other eye is used for AF.

3. Aim the camera at the subject.

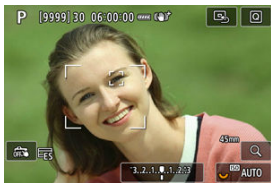

- A tracking frame is displayed around their eye.
- To choose an eye to focus on when **[AF: AF area]** is set to **[Whole area AF]**, either tap the screen or use **< * >**. As you use **< * >**, the tracking frame changes again to **[*]**.
- You can also tap the screen to choose an eye, when **[AF: AF area]** is set to **[Whole area AF]** or during tracking in progress.
- If your selected eye is not detected, an eye to focus on is selected automatically.

4. Take the picture.

! Caution

- Depending on the subject and shooting conditions, subject eyes may not be detected correctly, or a subject's left or right eye may not be prioritized correctly.
- Eyes are not detected when **[AF: Subject to detect]** is set to **[None]**.

📄 Note

- In **[AF: L/R eye detection]**, you can limit the available detection setting options to your preferred options.

Soccer, volleyball, or basketball players you are shooting can be treated as priority subjects for detection and AF tracking, based on typical movements (actions) in each sport.

⚠ Caution

- Unintended tracking may occur if this feature is used for other sports or general photography.

📄 Note

- Available under the following conditions.
 - Still photo shooting
 - **[AF: Subject to detect]: [People]**
 - **[📷: Shutter mode]: [Electronic **

1. Select **[AF: Action Priority]** (.
2. Configure **[Action Priority]**.

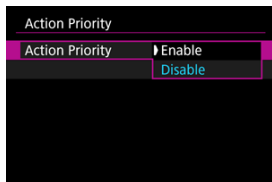

- Select **[Enable]**, then press <  >.

3. Select [Sport events].

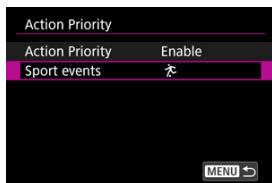

4. Select an option.

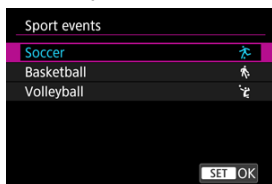



- Select a sport, then press < (SET) >.

Caution

- The following kinds of subjects may not be recognized as priority subjects based on their movement.
 - Small subjects
 - Too bright or dark
 - Partially hidden or outside the angle of view
 - Facing away from the camera
 - Difficult to distinguish from the background
 - Obscured by rain, snow, or dust clouds
 - Wearing uniforms that make it difficult to determine their posture
 - Crowded together, in front of/behind each other
 - In scenes where the ball is not visible or only partly visible
 - Greatly out of focus
 - Under flickering light
- The camera may switch subjects to track players moving similarly to the actions targeted by Action Priority (such as feinting a kick in soccer).
- When several subjects are moving in typical ways at once, Action Priority may cause the camera to switch subjects repeatedly.
- Action Priority may cause the camera to switch subjects repeatedly when several players are near the ball.
- The camera may switch to other subjects near a ball, even if they are not moving in typical ways.

Note

- For details on actions that can be recognized, refer to the AF Setting Guide. 
- Operation is as follows with [**AF: Action Priority**] set to [**Enable**].
 - Tracking switches to subjects moving in typical ways once they are recognized, even if a different subject was being tracked. However, Action Priority does not switch subjects if you start tracking with touch or button operations.
 - Even with [**AF: Register people priority**] set to [**Enable**], the camera prioritizes switching based on Action Priority.
- You can assign [**Enable**] or [**Off**] in [**AF: Action Priority**] to any button in [: **Customize buttons for shooting**] .
- With [**AF: Whole area tracking Servo AF**] set to [**Off**], the camera only switches subjects within the AF area.

Tracking with a Button

You can press a button assigned to **[Start/stop whole area AF tracking]** in **[Customize buttons for shooting]** to track subjects with a tracking frame [Lb]. This example is based on assigning the **< AF-ON >** button (Ⓜ).

1. Check the AF point.





(1)

- The AF point (1) will appear.
- With Expand AF area: $\frac{\square}{\square}$ or Expand AF area: Around, adjacent AF points are also displayed.
- With Flexible Zone AF, the specified Zone AF frame is displayed.

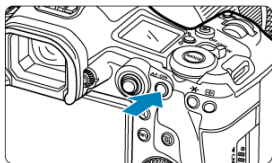
2. Press the < AF-ON > button.



- The AF point changes to a tracking frame [], which locks on to that subject for tracking and follows the subject within the screen if it moves. To cancel tracking, press the < AF-ON > button again.
- The tracking frame changes to [] when multiple subjects can be detected, and you can use <  > to choose a subject to focus on.
- Once tracking begins, the subject is tracked across the entire screen, regardless of the specified AF area.
- The position of AF areas and points when tracking stops after you press the shutter button halfway or completely corresponds to the position of the tracking frame during tracking. The position of AF areas and points when tracking stops during shooting standby corresponds to the position before tracking.

3. Take the picture.

Manually Setting AF Points or Zone AF Frames

You can manually set the AF point or Zone AF frame. Here, Flexible Zone AF 1 screens are used as an example.

1. Check the AF point.







(1)

- The AF point (1) will appear.
- With Expand AF area:  or Expand AF area: Around, adjacent AF points are also displayed.
- With Flexible Zone AF, the specified Zone AF frame is displayed.

2. Move the AF point.



- Use  to move the AF point into position for focusing (but note that with some lenses, it may not move to the edge of the screen).
- You can also focus by tapping a position on the screen.
- To center the AF point or Zone AF frame, press  straight in or tap .
- You can resize Zone AF frames used for Flexible Zone AF .

3. Focus and take the picture.

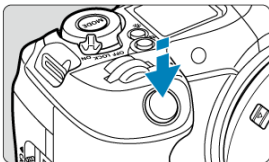

- Aim the AF point over the subject and press the shutter button halfway.



- When focus is achieved, the AF point turns blue.
- If focus is not achieved, the AF point will turn orange.

⚠ Caution

- The camera will keep moving the AF point [□] to track subjects when set to Flexible Zone AF and Servo AF, but under some shooting conditions (such as when subjects are small), it may not be possible to track the subject.
- Focusing may be difficult when using a peripheral AF point. In this case, select an AF point in the center.
- Tapping the screen to focus will focus with [One-Shot AF], regardless of the AF operation setting.

📱 Note

- You can set AF areas and AF points when [AF: Orientation linked AF point] is set to [Separate AF pts: Area+pt] (🔗).

Adjusting the Zone AF Frame Size

You can resize the Zone AF frame displayed for Flexible Zone AF 1–3.

1. Press the **< [] >** button during shooting screen display.
2. Press the **< RATE >** button.



3. Adjust the Zone AF frame size.



- Use the **< [] >** or **< [] >** dial to adjust the Zone AF frame size, then press **< [] >**.
- To restore the default setting, press the **< INFO >** button.

Registering AF Points (Home Position)

You can register the position of a frequently used AF point. To switch from the current AF point to your registered AF point, you can use a button you assign to recalling the home position on advanced setting screens for **[Direct AF point selection]**, **[Metering and AF start]**, **[Switch to registered AF point]**, or **[Register/recall shooting func]** in **[Customize buttons for shooting]** (🔗).

1. Select your preferred AF area.





- Press the < [1] > button to select an AF area.
- Move the AF point or Zone AF frame to the position to register.

2. Register the AF point or Zone AF frame.

- Hold down the < [1] > button and press the < ⌂ > button, or press and hold the < ⌂ > button, so that the camera beeps and registers the AF point.
- The registered AF point blinks in gray.
- Registration when the camera is set to Whole area AF will register the entire AF area as the home position.



Note

- To clear registered AF points, hold down the <  > button and press the < **MODE** > button, or press and hold the < **MODE** > button.
- You can also clear registered AF points by clearing all camera settings.
- You can register separate home positions for each camera orientation when the orientation-linked AF point setting () is set to [**Separate AF pts: Area+pt**] or [**Separate AF pts: Pt only**].
- Although it has no effect if you attempt to register a home position while a subject is being tracked with a tracking frame, you can clear registered positions at this time.

Magnified View

To check the focus, you can magnify display by approx. 6× or 15× by pressing the <Q> button (or tapping [Q]).

- Magnification is centered on the tracking frame when the tracking frame is white (as an active frame) after subject detection.
Magnification is centered on the AF point (in the center of the screen) when subjects are detected and the tracking frame is gray, or when subjects cannot be detected.
- Autofocusing is performed in magnified view if you press the shutter button halfway.
- When set to Servo AF or AI Focus AF, pressing the shutter button halfway in magnified view reverts to the normal view for focusing.

Caution

- If focusing is difficult in the magnified view, return to the normal view and perform AF.
- If you perform AF in the normal view and then use the magnified view, accurate focus may not be achieved.
- AF speed differs between the normal view and magnified view.
- Preview AF and Movie Servo AF are not available in magnified view.
- With the magnified view, achieving focus becomes more difficult due to camera shake. Using a tripod is recommended.

AF Shooting Tips

- Even when focus is achieved, pressing the shutter button halfway will focus again.
- Image brightness may change before and after autofocusing.
- Depending on the subject and shooting conditions, it may take longer to focus, or the continuous shooting speed may decrease.
- If the light source changes as you shoot, the screen may flicker, and focusing may be difficult. In this case, restart the camera and resume shooting with AF under the light source you will use.
- If focusing is not possible with AF, focus manually (☑).
- For subjects at the edge of the screen that are slightly out of focus, try centering the subject (or AF point, or Zone AF frame) to bring them into focus, then recompose the shot before shooting.
- With certain lenses, it may take more time to achieve focus with autofocus, or accurate focusing may not be achieved.

Shooting Conditions That Make Focusing Difficult

- Subjects with low contrast, such as a blue sky or flat surfaces in solid colors, or other cases when highlight or shadow details are clipped.
- Subjects in low light.
- Stripes and other patterns where there is contrast only in the horizontal direction.
- Subjects with repetitive patterns (Example: Skyscraper windows, computer keyboards, etc.).
- Fine lines and subject outlines.
- Under light sources with constantly changing brightness, colors, or patterns.
- Night scenes or points of light.
- The image flickers under fluorescent or LED lighting.
- Extremely small subjects.
- Subjects at the edge of the screen.
- Strongly backlit or reflective subjects (Example: Car with a highly reflective surfaces, etc.).
- Near and distant subjects covered by an AF point (Example: Animal in a cage, etc.).
- Subjects that keep moving within the AF point and will not stay still due to camera shake or subject blur.
- Performing AF when the subject is very far out of focus.
- Soft focus effect is applied with a soft focus lens.
- A special effect filter is used.
- Noise (dots of light, banding, etc.) appears on the screen during AF.

AF Range

The available autofocus range varies depending on the lens used and settings such as aspect ratio, movie recording size, and Movie digital IS.

Manual Focus

[☑ Setting MF Peaking \(Outline Emphasis\) ☆](#)

[☑ Focus Guide](#)

You can magnify display to check the focus when you are focusing manually.

1. Set the focus mode to MF.

- **For RF lenses with a focus mode switch**
Set the lens's focus mode switch to <MF>.

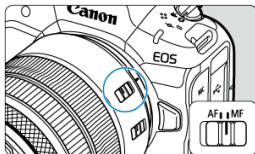

- **For RF lenses without a focus mode switch**
Set [**AF**: Focus mode] to [MF].

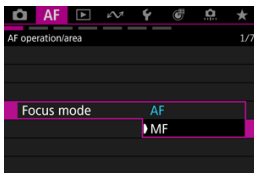

2. Focus manually.

- Turn the lens focusing ring to set the approximate focus.

3. Magnify the image.



- Each press of the < Q > button changes the magnification ratio, as follows.

→ x6 → x15 → x1 →

4. Move the magnified area.



- Use < * > to move the magnified area into position for focusing.
- To center the magnified area, press < * > straight in.

5. Adjust the focus position.

- While looking at the magnified image, turn the lens focusing ring to focus.
- After focusing, press the < Q > button to return to the normal view.

Note

- In magnified view, the exposure is locked.
- Even when focusing manually, you can use Touch Shutter to shoot.

Edges of subjects in focus can be displayed in color to make focusing easier. You can set the outline color and adjust the sensitivity (level) of edge detection.

1. Select [**AF**: MF peaking settings] (🔍, 🔍).

2. Select [**Peaking**].

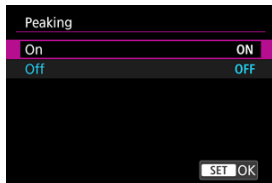

- Select [**On**].

3. Set [**Level**] and [**Color**].

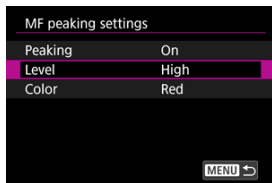

- Set as necessary.

! Caution

- In magnified view, peaking display is not shown.
- During HDMI output, peaking display is not shown on equipment connected via HDMI. Note that peaking display is shown on the camera screen when [📷: HDMI display] is set to [📷+📺].
- MF peaking may be hard to discern at high ISO speeds, especially when ISO expansion is set. If necessary, lower the ISO speed or set [**Peaking**] to [**Off**].



Note

- Peaking display shown on the screen is not recorded in images.
- MF peaking may be hard to discern under the following settings. Set [: :] **HDR/C.Log View Assist.** as needed.
 - With [: **Custom Picture**] gamma set to [Canon Log 2], [Canon Log 3], or [PQ]
 - With [:] **HDR shooting (PQ)**] set to [HDR PQ]

Setting **[AF: Focus guide]** to **[On]** provides a guide frame that shows which direction to adjust focus and the extent of adjustment needed. You can also use eye control to display the focus guide at your preferred position. For details, see [Using Eye Control for AF](#).

1. Select **[AF: Focus guide]** (👁️, 👁️).
2. Select **[On]**.

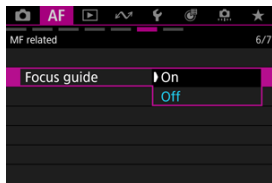

- The guide frame is displayed on the face of any person detected as the main subject.
- To display the guide frame on the face of the person detected as the main subject, set **[AF: Subject to detect]** to an option other than **[None]**. You can also display the guide frame near the eyes of the person detected as the main subject by setting **[AF: Eye detection]** to an option other than **[Disable]**.
- After pressing the < [👁️] > button, you can use < * > to move the guide frame in the direction you press (except in **[AF+]** mode).
- To set the guide frame after moving it with < * >, press < (SET) >.
- You can also move and set the guide frame by tapping the screen.
- To center the guide frame, tap **[👁️]** or press < * > straight in.

The guide frame indicates the current position in focus and adjustment amount as follows.

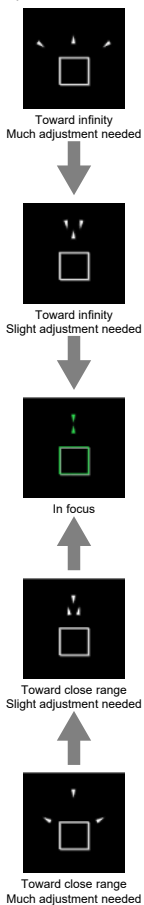

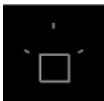

Adjustment information
not detected

Caution

- Under difficult shooting conditions for AF (AF-ON), the guide frame may not be displayed correctly.
- Higher aperture values are more likely to prevent correct guide frame display.
- No AF points are displayed while the guide frame is displayed.
- The guide frame is not displayed in these situations.
 - When the focus mode is set to AF (AF-ON)
 - When display is magnified
- The guide frame is not displayed correctly during shifting or tilting of TS-E lenses.

Note

- The camera's auto power off counter does not count time spent adjusting the focus with a lens's electronic focusing ring.

- [Registering Faces](#)
- [Changing or Removing the Priority of Registered People](#)
- [Enabling Detection of Registered People's Faces](#)
- [Clearing All Registered People](#)
- [Saving and Loading Registered Data](#)

You can register people on the camera to have the camera attempt to detect their faces and prioritize focusing, brightness, and color tone for them when you shoot. To register a face, you can take a picture of someone, or you can use an image on the card.

Caution

- The camera stores face images and related information registered using this feature. Delete all registered information before disposing of the camera or transferring ownership.
- When using this feature, be aware of the need to protect personal information and comply with privacy regulations, as by asking people for their consent before registering their information. Canon cannot be held liable for any personal information issues arising from use of this feature.

Registering people by taking their picture

1. Select [**AF**: Register people priority] (☒, ☒).
2. Select [**Photograph people and register**].

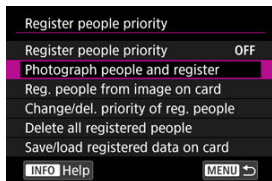

3. Aim the frame over the face of a person to register, then take their picture.

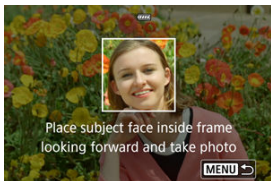

- Shoot under ample light with the subject facing you.
- Ask subjects to pose with a natural facial expression before you shoot.
- For best results, ask subjects to take off any hats, masks, sunglasses, or other coverings before you take their picture.
- It may improve detection accuracy to register faces immediately before you will shoot.
- Under these shooting conditions, detection may be less accurate, and it may not be possible to register faces.
 - Faces are too small, relative to the frame
 - Faces are partially shaded
 - Faces are partially hidden
 - Faces are displayed on a computer or smartphone screen

4. Select [OK].

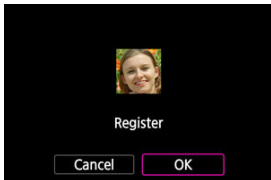

- The image displayed may look different from how you composed the shot in step 3, but this will not affect detection accuracy.

Registering people from images on the card

JPEG or HEIF images can be used. Process any RAW images you will use into JPEGs or HEIFs before saving them to the card.

Caution

- With the following images, detection may be less accurate, and it may not be possible to register faces.
 - Faces are partially hidden
 - Faces are partially shaded
 - Faces are displayed on a computer or smartphone screen

Note

- For best results, make sure that faces in the images meet these guidelines.
 - Well lit and facing you
 - Not wearing any hats, masks, sunglasses, or other coverings
 - Natural facial expression
 - Faces are not too small or large relative to the screen

1. Select [Reg. people from image on card].

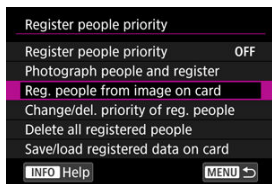

2. Switch to playback.



- Press < SET >.

3. Select a face.

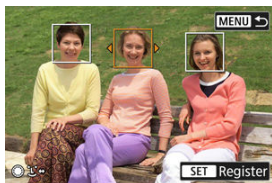

- For pictures that show more than one person, you can use the < [dial icon] > < [dial icon] > dials or < [dial icon] > to move the orange frame over the face to register.
- Press < SET >.

4. Select [OK].

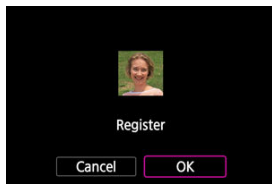

- After the following screen appears, you can register another person's face.

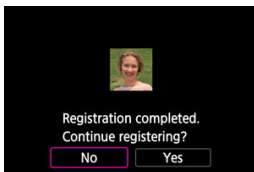

Display when registered faces are detected

A white frame with [👤] appears on any registered faces that are detected on the shooting screen. Note that [👤] is not displayed when One-Shot AF or Servo AF is used.

⚠ Caution

- Detection may be less accurate under these conditions.
 - Subjects are not directly facing you
 - Faces are too light or dark
 - Faces are too small or large relative to the screen
 - Subjects have a much different facial expression from the one in registered images
 - Subjects are moving too much
 - Faces are covered by a hat, mask, sunglasses, or other objects
 - Subject faces look much different from how they look in registered images
- Unregistered people may be mistakenly detected as registered people whom they resemble.
- If faces of registered people are not detected, or if detection is not accurate, try clearing the registered information and registering it again.



Note

- When [**AF: Subject to detect**] is set to an option other than [**People**], priority is given to the subject specified in that setting.

Changing or Removing the Priority of Registered People

You can change detection priority by rearranging registered people. You can also remove registered people.



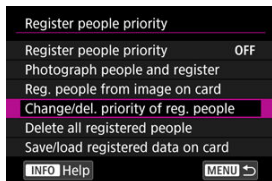

Changing detection priority

1. Select [Change/del. priority of reg. people].

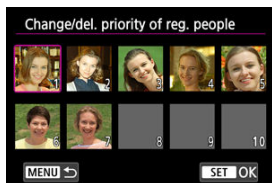

2. Select the face of a registered person.



- Select with the <  > <  > dials or <  >, then press <  >.

3. Change the priority.

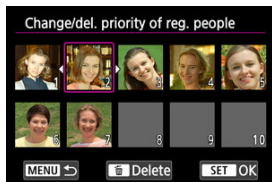

- Move with the < ⌚ > < ⌚ > dials or < * >, then press < SET >.
- When finished changing priority, press the < MENU > button.

Removing registered people

1. Select the face of a registered person.



- Select with the < ⌚ > < ⌚ > dials or < * >, then press < SET >.

2. Press the < 🗑️ > button.

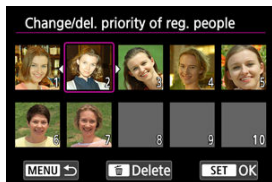

3. Select [OK].

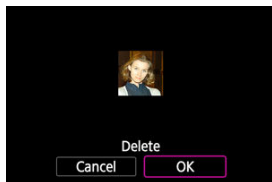

- Press the < MENU > button to exit.

1. Select [Register people priority].

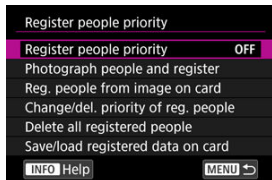

2. Select [Enable].

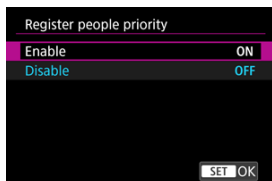

Clearing All Registered People

Delete all registered information before disposing of the camera or transferring ownership.

1. Select [Delete all registered people].

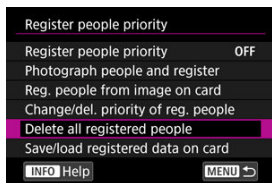

2. Press < (SET) >.

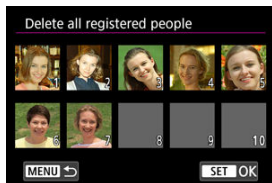

3. Select [OK].



- Press <  >.

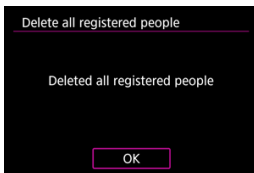

Note

- Performing [**Factory reset**] in [: **Reset camera**] also clears the information for all registered people.

Saving and Loading Registered Data

Registered face data can be saved to a card. Registered data on a card can be used with other EOS R5 Mark II or EOS R1 cameras. You can also use registered data from other EOS R5 Mark II or EOS R1 cameras.

1. Select [Save/load registered data on card].

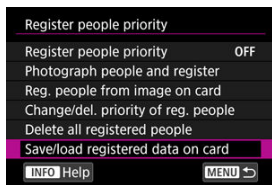

2. Select [Save registration data on card].

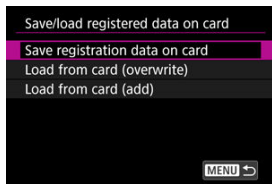

- Select [**Save registration data on card**] to save the camera's registered data to the card.
- To rename the registered data file before saving it, press the < **INFO** > button on the following screen.



- To load registered data from the card and overwrite existing data on the camera, select [**Load from card (overwrite)**]. Any existing registered data on the camera is deleted.
- To add registered data from the card to the camera, select [**Load from card (add)**]. No existing registered data on the camera is deleted.
 - Registered data is loaded starting from the person with the highest priority.
 - Once the camera is full of registered data, no more data is loaded.

☑ [Case Auto](#)

☑ [Case Manual](#)



Shooting with optimal Servo AF for your subject or shooting situation is easy.

Case Auto

You can set Servo AF tracking parameters (subject tracking sensitivity and acceleration/ deceleration tracking) for the subject and shooting situation.

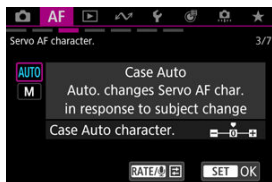
1. Select **[AF: Case Auto]**.



- Turn the <  > dial to select **[AUTO]**, then press <  >.
- The case is set to auto and **[AUTO]** is displayed in blue.



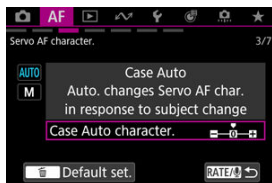

2. Adjust [Case Auto character.].

- Press the < **RATE** /  > button. The selected parameter is outlined in purple.

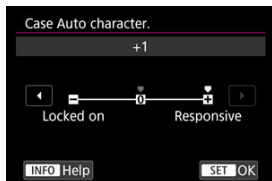

- Press <  > to select [Case Auto character.].



- To select an adjustment value, use the <  > or <  > dial.
- Default settings are indicated by a light gray  icon.
- Press <  > when finished.

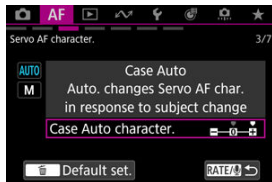

- Press the < **RATE** /  > button to return to the screen in step 1.

Case Auto tracking parameters

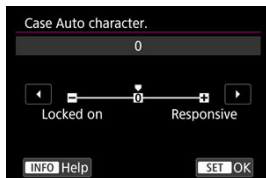



It may be easier to focus if you modify the default Case Auto setting.

- **0**
Standard setting. Generally recommended, as an option that is useful in many situations.
- **Locked on: -1**
Keeps the tracked subject in focus as much as possible, even if objects are momentarily in front of it, or if it strays from AF points after moving suddenly.
- **Responsive: +1**
Makes it easier for the camera to switch tracked subjects if you want to capture several subjects in succession, for example.

You can set Servo AF tracking parameters as needed for shooting conditions.

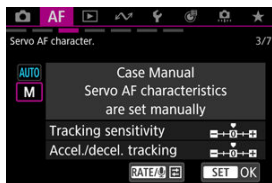
1. Select **[AF: Case Manual]**.





- Turn the <  > dial to select **[M]**, then press <  >.
- The case is set to manual and **[M]** is displayed in blue.



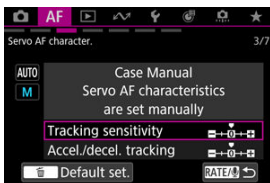

2. Adjust [Case Manual] tracking parameters.

- Press the < **RATE** /  > button. The selected parameter is outlined in purple.

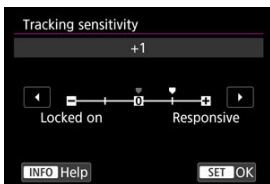

- Use the <  > or <  > dial to select a setting to adjust, then press <  >.



- To select an adjustment value, use the <  > or <  > dial.
- Default settings are indicated by a light gray  icon.
- Press <  > when finished.

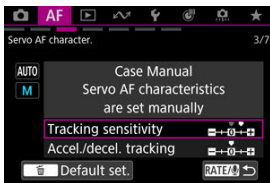

- Press the < **RATE** /  > button to return to the screen in step 1.

Tracking sensitivity

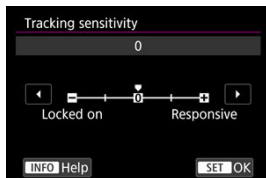

Setting for Servo AF subject-tracking sensitivity in response to non-subjects moving across AF points or subjects straying from AF points.

- **0**

Standard setting. Suitable for moving subjects in general.

- **Locked on: -2 / -1**

The camera will try to continue focusing on the subject even if non-subjects move across AF points or if the subject strays from the AF points. The -2 setting makes the camera keep tracking the target subject longer than the -1 setting.

However, if the camera focuses on a wrong subject, it may take slightly longer to switch and focus on the target subject.

- **Responsive: +2 / +1**

The camera can focus consecutively on subjects at different distances that are covered by the AF points. Also effective when you want to always focus on the closest subject.

The +2 setting is more responsive than the +1 setting when focusing on the next subject.

However, the camera will be more prone to focus on an unintended subject.

Acceleration/deceleration tracking

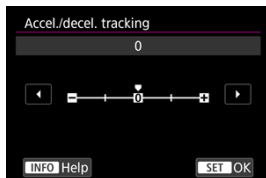

Setting for subject-tracking sensitivity in response to sudden, significant changes in speed, as when subjects suddenly start or stop moving.

- **0**
Suited for subjects that move at a steady speed (minor changes in moving speed).
- **-2 / -1**
Suited for subjects that move at a steady speed (minor changes in moving speed). Effective when a setting of 0 makes focus unstable, due to slight subject movement or an obstruction in front of the subject.
- **+2 / +1**
Effective for subjects having sudden movements, sudden acceleration/deceleration, or sudden stops. Even if the moving subject's speed suddenly changes significantly, the camera continues to focus on the target subject. For example, the camera is less likely to focus behind a subject that suddenly starts approaching you, or in front of an approaching subject that suddenly stops moving. Setting +2 can track dramatic changes in the moving subject's speed better than with +1.
However, since the camera will be sensitive to even slight movements of the subject, focusing may become unstable for short periods.

Customizing AF Functions

- [\[Customize AF operation\]](#)
- [\[Customized controls\]](#) ☆
- [\[MF related\]](#) ☆
- [\[Various settings/Various settings\]](#) ☆
- [\[Subject detection\] \(in movie recording\)](#) ☆
- [\[Servo AF character.\] \(in movie recording\)](#) ☆

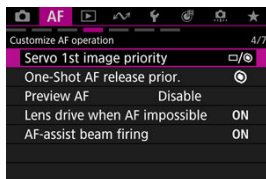

You can configure AF functions in detail to suit your shooting style or subject.

Servo 1st image priority☆

You can set AF operating characteristics and shutter-release timing for the first shot with Servo AF.

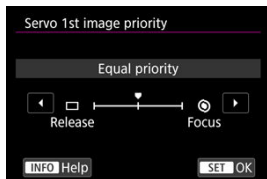

- **□/⊙: Equal priority**
Equal priority is given to focusing and shutter-release timing.
- **□: Release**
Pressing the shutter button takes the picture immediately even if focus has not been achieved. Useful when you want to give priority to capturing the decisive moment rather than achieving focus.
- **⊙: Focus**
Pressing the shutter button does not take the picture until focus is achieved. Useful when you want to achieve focus before capturing the image.

Note

- The second and subsequent shots in continuous shooting prioritize the release timing.

One-Shot AF release priority ☆

You can specify whether to prioritize focus or release timing for One-Shot AF (except when shooting with Touch Shutter).

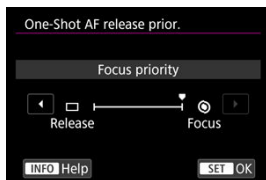

- **🎯: Focus**

The picture will not be taken until focus is achieved. Useful when you want to achieve focus before capturing the image.

- **□: Release**

Prioritizes shutter release over focus. Useful when capturing the decisive moment is most important.

Note that the camera shoots whether or not the subject is in focus.

Preview AF

Keeps subjects generally in focus before you start shooting. When set to **[Enable]**, the camera is ready to focus immediately after you press the shutter button halfway.

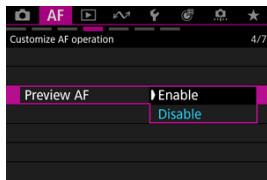

⚠ Caution

- Fewer shots are available when set to **[Enable]**, because the lens is driven continuously and battery power is consumed.

Lens operation when AF is not available☆

You can specify lens operation that applies when autofocusing on a subject is not possible.

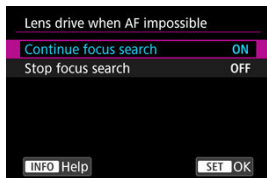

- **ON: Continue focus search**

If focus cannot be achieved with autofocus, the lens is driven to search for the precise focus.

- **OFF: Stop focus search**

If autofocus starts and the focus is far off or if focus cannot be achieved, the lens drive will not be performed. This prevents the lens from becoming grossly out of focus due to the focus search drive.

⚠ Caution

- **[Stop focus search]** is recommended for super telephoto lenses or other lenses that are driven over a large focus area, to avoid significant delay from focus search drive if the lens becomes greatly out of focus.

AF-assist beam firing

You can enable or disable AF-assist beam firing of the camera or a Speedlite for EOS cameras.

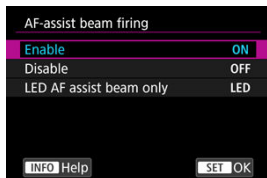

- **ON: Enable**
Enables firing of the AF-assist beam, when needed.
- **OFF: Disable**
Disables firing of the AF-assist beam. Set if you prefer not to fire the AF-assist beam.
- **LED: LED AF assist beam only**
Enables LED AF-assist beam firing by Speedlites equipped with this feature, when these flash units are attached. If your Speedlite is not LED-equipped, the camera's AF-assist beam is fired instead.

⚠ Caution

- Speedlite AF-assist beam firing is disabled when the Speedlite's [**AF: AF-assist beam firing**] Custom Function is set to [**Disable**].

Limit AF areas

You can limit the AF areas available to the areas that you normally use. Select available AF areas and press < **SET** > to add a checkmark [✓]. Select [**OK**] to register the setting. For details on AF areas, see [AF Area](#).

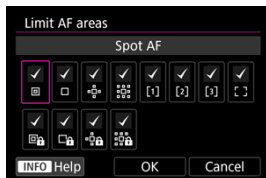

! Caution

- The [✓] mark cannot be cleared from all items at the same time.

📄 Note

- An asterisk to the right of [**AF: Limit AF areas**] indicates that the default setting has been modified.

Orientation-linked AF points

You can set separate types of AF areas or positions of AF points for vertical and horizontal shooting.

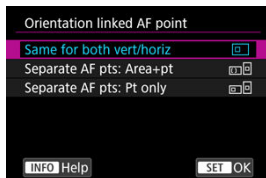

- : **Same for both vert/horiz**

The same AF points or Zone AF frames in the same AF areas are used in both vertical and horizontal shooting.

- : **Separate AF pts: Area+pt**

Separate types of AF areas or separate AF points or Zone AF frames can be set for each camera orientation ((1) Horizontal, (2) Vertical with the camera grip up, (3) Vertical with the camera grip down ).

Useful when switching to other types of AF areas or positions of AF points or Zone AF frames automatically based on camera orientation.

AF areas and AF points or Zone AF frames you assign to each of the three camera orientations are retained.

- : **Separate AF pts: Pt only**

Separate AF points or Zone AF frames can be set for each camera orientation ((1) Horizontal, (2) Vertical with the camera grip up, (3) Vertical with the camera grip down). Useful when switching to other positions of AF points or Zone AF frames automatically based on camera orientation.

Positions of AF points or Zone AF frames you assign to each of the three camera orientations are retained.

Caution

- The default setting of [**Same for both vert/horiz**] is restored if you select [**Basic settings**] in [**Reset camera**] . Settings for orientations (1)–(3) are cleared, and the camera is set to use the center Zone AF frame in Flexible Zone AF 1.
- The setting may be cleared if you switch lenses.

Limit subject to detect

You can limit the available setting options in [**AF: Subject to detect**] to your preferred options. Select an option to exclude and press < **SET** > to clear [✓]. Select [**OK**] to register the setting.

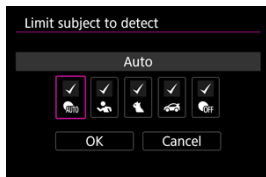

! Caution

- The [✓] mark cannot be cleared from all items at the same time.

📄 Note

- An asterisk to the right of [**AF: Limit subject to detect**] indicates that the default setting has been modified.

Left/right eye detection

You can limit the available setting options in [**AF: Eye detection**] to your preferred options. Select an option to exclude and press <ⓈET> to clear [✓]. Select [**OK**] to register the setting.

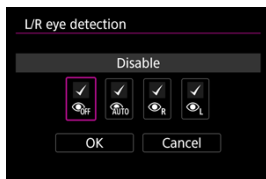

⚠ Caution

- The [✓] mark cannot be cleared from all items at the same time.

📄 Note

- An asterisk to the right of [**AF: L/R eye detection**] indicates that the default setting has been modified.

Lens electronic MF

For attached lenses that support electronic manual focusing, you can specify the operation of manual focus adjustment.



- **OFF: Disable**
Manual focus adjustment is disabled when the lens's focus mode switch is set to < AF >.
- **OFF: Disable after One-Shot**
After One-Shot AF, manual focusing adjustment is disabled.
- **ON: One-Shot→enabled**
You can manually adjust the focus after the One-Shot AF if you keep holding down the shutter button halfway.
- **ON: One-Shot→enabled (magnify)**
You can manually adjust the focus after the One-Shot AF if you keep holding down the shutter button halfway. You can magnify the area in focus and adjust the focus manually by turning the lens focusing ring.
- **ON: Enable (actual size)**
Manual focus adjustment is always available when the camera is on with certain lenses*¹ attached.
With other lenses, operation is the same as [One-Shot→enabled].
- **ON: Enable (One-Shot→magnify)**
Manual focus adjustment is always available when the camera is on with certain lenses*¹ attached.
Turning the lens focusing ring after One-Shot AF magnifies the area in focus.
With other lenses, operation is the same as [One-Shot→enabled].

* 1: For details on lenses compatible with this feature, check the Canon website ([🌐](#)).

 **Caution**

- With [**One-Shot**→**enabled (magnify)**], display may not be magnified even if you turn the lens focusing ring while pressing the shutter button halfway immediately after shooting. If so, you can magnify display by releasing the shutter button, waiting for [Q] display, then pressing the shutter button halfway as you turn the lens focusing ring.

 **Note**

- For details on your lens's manual focus specifications, refer to the Lens Instruction Manual.

Register/recall AF-related settings

You can save current AF settings and apply them all at once.

Caution

- Current camera settings are listed on the screen in step 4, which is used to register settings. The items listed on this screen cannot be changed.
- The following **[AF]** tab items are not available for this feature.
 - One-Shot AF release priority
 - Preview AF
 - AF-assist beam firing
 - MF peaking settings
 - Focus guide

Register

1. Select **[AF: Register/recall AF-related settings]** (🔗).
2. Select **[Register settings]**.

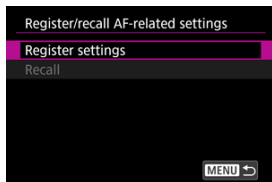

3. Select a name for the settings.

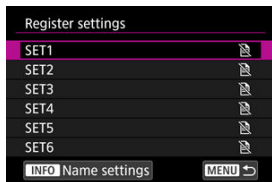

- [] is displayed by names for which AF settings have not been registered yet.
- To rename the settings, press the < INFO > button.

4. Select the AF settings to register.

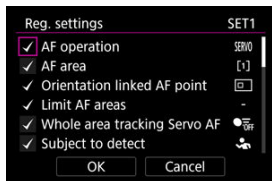

- All selected AF settings will be registered. To clear or reselect settings, turn the < [] > dial to select the setting, then press < [] >.
- When you are finished choosing settings, select [OK].

Recall

1. Select [**AF**: Register/recall AF-related settings] (🔒).
2. Select [Recall].

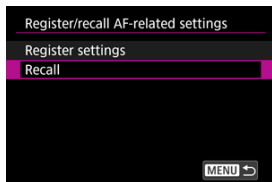

3. Select a name for the settings.

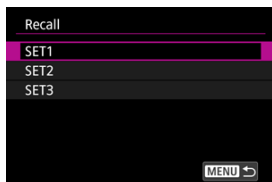

- Turn the <🌀> dial to select a name, then press <🔒> to confirm your selection.

4. Review the registered details and select [OK].

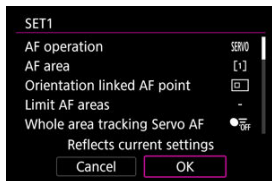

- You can use <⚙️> to scroll the screen when reviewing registered details.

AF Setting Guide URL

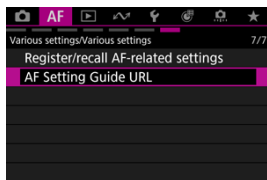

Select [**AF**: AF Setting Guide URL] (📄) to display the QR code. Scan the QR code with your smartphone to access the AF Setting Guide.

Switching tracked subjects

You can set how easily the camera switches tracked subjects.

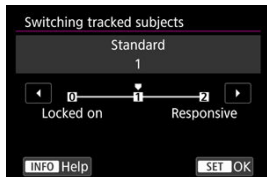

- **Standard**

After determining the main subject from how your shot is composed, the camera tracks subjects or switches to others accordingly.

- **Locked on**

Switches tracked subjects later than with **[Standard]**.

- **Responsive**

Switches tracked subjects sooner than with **[Standard]**.

⚠ Caution

- Subjects selected by touch operations are tracked to the extent possible, regardless of the **[AF: Switching tracked subjects]** setting.

Movie Servo AF speed

You can set the AF speed for Movie Servo AF. This function is enabled with **[Movie Servo AF]** in **[AF: Movie Servo AF]** set to **[Enable]** when you are using lenses compatible with slow focus transition during movie recording.*

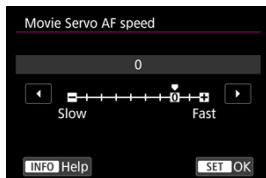

You can adjust the AF speed (focus transition speed) from the standard speed (0) to slow (one of seven levels) or fast (one of two levels) to obtain the desired effect for the movie creation.

* Lenses supporting slow focus transition during movie recording

USM and STM lenses released in and after 2009 are compatible. For details, refer to the Canon website ([link](#)).

Caution

- With certain lenses, even if you adjust the AF speed, the speed may not change.

Note

- Operation when inactive is equivalent to when **[AF speed]** is set to **[Standard (0)]**.
- An AF speed value to the right of **[AF: Movie Servo AF speed]** indicates that the default setting has been modified.

Movie Servo AF tracking sensitivity

You can adjust the tracking sensitivity (to one of seven levels), which affects responsiveness if the subject strays from the AF point during Movie Servo AF, as when interfering objects move across AF points or when you pan.

This function is available when [Movie Servo AF] in [AF: Movie Servo AF] is set to [Enable].

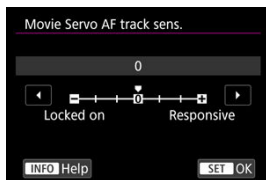

- **Locked on: -3/-2/-1**

With this setting, the camera is less likely to track a different subject if the subject strays from the AF point. The closer the setting is to the minus (-) symbol, the less the camera is inclined to track a different subject. It is effective when you want to prevent the AF points from rapidly tracking something that is not the intended subject during panning or when an obstacle cuts across the AF points.

- **Responsive: +1/+2/+3**

This makes the camera more responsive when tracking a subject that covers the AF point. The closer the setting is to the plus (+) symbol, the more responsive the camera is. It is effective when you want to keep tracking a moving subject as its distance from the camera changes or to rapidly focus on another subject.

 **Note**

- Operation when inactive is equivalent to when set to [0].

Focus Preset

You can set your preferred focus positions in advance on the camera when using RF or RF-S lenses. Saved focus preset positions can be applied by pressing a button during standby.

Registering a focus position on the camera

Focus at the focusing distance to register as a preset, then press the button assigned to **[Register focus preset]**.

Recalling preset focus positions

Press the button assigned to **[Recall focus preset]**.

Caution

- Before using focus presetting, you must assign **[Register focus preset]** and **[Recall focus preset]** to buttons of your choice in : **Customize buttons for shooting**.

Note

- Focus presetting is available in AF and MF focus mode.
- Registered focus positions are cleared when you switch lenses or change camera batteries.

Selecting the Drive Mode

[Switching Continuous Shooting Modes](#)

Single and continuous drive modes are provided. You can select the drive mode suiting the scene or subject.

1. Press the <M-Fn> button (6).

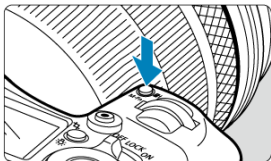

- With an image displayed on the screen, press the <M-Fn> button.

2. Select the drive mode item.



- Press the <M-Fn> button to select the drive mode item.

3. Select the drive mode.

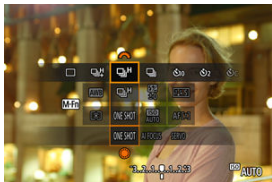

- Turn the <  > dial to make a selection.

- : **Single shooting**

When you hold down the shutter button completely, only one shot will be taken.

- : **High-speed continuous shooting +**

When you hold down the shutter button completely, you can shoot continuously as described below while you keep holding it down, based on the [: **Shutter mode**] setting.

- [**Mechanical**]: max. approx. 12 shots/sec.
- [**Elec. 1st-curtain**]: max. approx. 12 shots/sec.
- [**Electronic $\overline{\text{E}}\text{S}$**]: max. approx. 30 shots/sec.

- : **High-speed continuous shooting**

When you hold down the shutter button completely, you can shoot continuously as described below while you keep holding it down, based on the [: **Shutter mode**] setting.

- [**Mechanical**]: max. approx. 6 shots/sec.
- [**Elec. 1st-curtain**]: max. approx. 8.2 shots/sec.
- [**Electronic $\overline{\text{E}}\text{S}$**]: max. approx. 15 shots/sec.

- : **Low-speed continuous shooting**



When you hold down the shutter button completely, you can shoot continuously as described below while you keep holding it down, based on the [: **Shutter mode**] setting.

- [**Mechanical**]: max. approx. 3 shots/sec.
- [**Elec. 1st-curtain**]: max. approx. 3 shots/sec.
- [**Electronic $\overline{\text{E}}\text{S}$**]: max. approx. 5 shots/sec.

- : **Self-timer: 10 sec.** / : **Self-timer: 2 sec.** / : **Self-timer: Continuous shooting**



For details on []/[]/[], see [Using the Self-Timer](#).

Caution



-  enables approx. 30 shots/sec. continuous shooting speed when set to **[Electronic ** under these conditions.

- Shutter speed: 1/250 sec. or faster
- Flicker reduction: None





Note that the continuous shooting speed may be slower than 30 shots/sec. if any of the following occurs, or after certain operations in continuous shooting.

- Switching to **[P]** or **[Tv]** shooting mode, or applying settings that cause the aperture value to change in **[Fv]** mode
 - Zooming is performed
 - Manual focusing is performed
 - Servo AF changes the position in focus
 - A power source other than Battery Pack LP-E6P or DC Coupler DR-E6P is used
- Various factors may lower the continuous shooting speed, such as battery level, temperature, shutter speed, aperture value, subject conditions, brightness, AF operation, type of lens, use of flash, and shooting settings.
 - Visit the Canon website for details on lenses supporting the maximum continuous shooting speed ().
 - Continuous shooting speed with Servo AF may be slower depending on subject conditions or the lens used.
 - The continuous shooting speed will be slower when shooting under flickering light.
 - When internal memory becomes full during continuous shooting, the continuous shooting speed may drop off because shooting will be temporarily disabled ().
 - Continuous shooting speed may be slower and image display in the viewfinder or on the screen may stop under some shooting conditions.

Note

- Continuous shooting speed indicated for each drive mode is the speed under default camera settings. When using the electronic shutter, you can set the continuous shooting speed for each drive mode in [:  **Continuous shooting speed**] ().

Switching Continuous Shooting Modes

In electronic shutter mode, you can temporarily change the continuous shooting mode by pressing the button assigned to **[Switch  cont. shooting modes]** in **[: Customize buttons for shooting]**. This example is based on assigning **[]** to the **< AF-ON >** button ().

1. Assign **[]** to the **< AF-ON >** button.





- Select **[Switch  cont. shooting modes]**, then press the **< INFO >** button.



- Select the continuous shooting mode to assign to the button, then press **<  >**.

2. During standby, press the **< AF-ON >** button.

- In **[H]** or **[]** drive mode, you can switch to **[]** continuous shooting for as long as you press the button.

Using the Self-Timer

Use the self-timer when you want to be in the picture such as a commemorative photograph.

1. Press the **<M-Fn>** button (Ⓜ6).

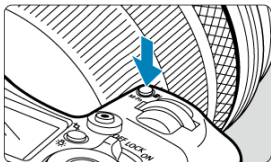

- With an image displayed on the screen, press the **<M-Fn>** button.

2. Select the drive mode item.



- Press the **<M-Fn>** button to select the drive mode item.

3. Select the self-timer.



- Turn the  dial to select the self-timer.

: Shoot in 10 sec.

: Shoot in 2 sec.

: Shoot continuously in 10 sec. for the specified number of shots*

* Set the number of shots taken continuously (2–10), either in [ Drive mode] or on the Quick Control screen.

4. Take the picture.

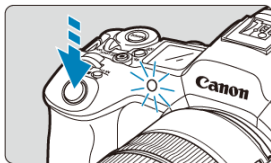

- Focus on the subject, then press the shutter button completely.
- To check operation, look at the self-timer lamp, listen for beeps, or watch the countdown in seconds on the screen.
- Self-timer lamp blinking accelerates and the camera beeps quickly approx. 2 sec. before the picture is taken.



Note

- [⌚] is used to start shooting without touching the camera (to avoid camera shake) when it is mounted on a tripod for shots such as still lifes or long exposures, for example.
- After taking self-timer shots, playing back the image (⏮) to check focus and exposure is recommended.
- When using the self-timer to shoot yourself, use focus lock (🔒) on an object at the same distance as where you will stand.
- To cancel the self-timer after it starts, either tap the screen or press < (⏪) >.
- Auto power off time may be extended when the camera is set for remote control shooting.

Remote Control Shooting

 [Wireless Remote Control BR-E1](#)

 [Remote Switch RS-80N3 / Timer Remote Controller TC-80N3](#)

For remote control shooting, you can use an optional Wireless Remote Control BR-E1 (Bluetooth) or an optional Remote Switch RS-80N3 or Timer Remote Controller TC-80N3 (both wired).

Wireless Remote Control BR-E1

You can shoot remotely up to approx. 5 meters/16.4 feet from the camera. First, pair the camera and BR-E1 () .

For operating instructions, refer to the BR-E1 instruction manual.



Note

- Auto power off time may be extended when the camera is set for remote control shooting.
- BR-E1 can also be used for movie recording.

Remote Switch RS-80N3 / Timer Remote Controller TC-80N3

Once connected to the camera, the switch enables you to shoot remotely over a wired connection.

For operating instructions, refer to the accessory instruction manual.

1. **Open the terminal cover.**
2. **Connect the plug to the remote control terminal.**

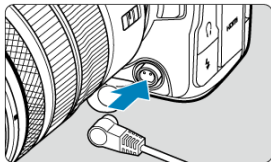

Playback

This chapter covers topics related to playback—playing back captured still photos and movies—and introduces menu settings on the playback [▶] tab.

Caution

- Normal display or configuration on this camera may not be possible for images captured on other cameras, or images from this camera that have been edited or renamed on a computer.
- Images that cannot be used with playback functions may be displayed.

- [Tab Menus: Playback](#)
- [Image Playback](#)
- [Magnified Image Display](#)
- [Index Display \(Multiple-Image Display\)](#)
- [Voice Memo Recording and Playback](#)
- [Movie Playback](#)
- [4K/8K Movie Frame Grab](#)
- [Playback on a TV Set](#)
- [Protecting Images](#)
- [Erasing Images](#)
- [Rotating Still Photos](#)
- [Changing Movie Orientation Information](#)
- [Rating Images](#)
- [Copying Still Photos](#)
- [Print Ordering \(DPOF\)](#)
- [RAW Image Processing](#)
- [In-Camera Upscaling](#)
- [Resizing JPEG/HEIF Images](#)
- [Cropping JPEG/HEIF Images](#)
- [Converting HEIF to JPEG](#)
- [Slide Show](#)
- [VR Preview](#)
- [Setting Image Search Conditions](#)
- [Resuming from Previous Playback](#)
- [Blur/Out-of-Focus Image Detection](#)
- [Customizing Playback Information Display](#)
- [Displaying the Highlight Alert](#)
- [AF Point Display](#)

- [Playback Grid](#)
- [Movie Play Count](#)

Tab Menus: Playback

● File operation

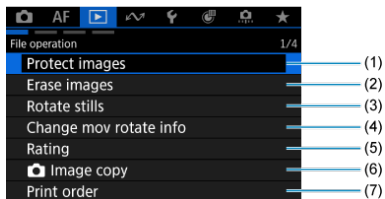

- (1) [Protect images](#)
- (2) [Erase images](#)
- (3) [Rotate stills](#)
- (4) [Change mov rotate info](#)
- (5) [Rating](#)
- (6) [Image copy](#)
- (7) [Print order](#)

● Image processing

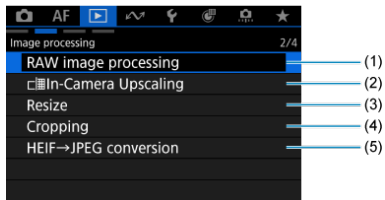

- (1) [RAW image processing](#)
- (2) [In-Camera Upscaling](#)
- (3) [Resize](#)
- (4) [Cropping](#)
- (5) [HEIF→JPEG conversion](#)

Caution

- [▶]: RAW image processing] and [▶]: HEIF→JPEG conversion] are not displayed in [A+] or [A+] mode.

● Playback method

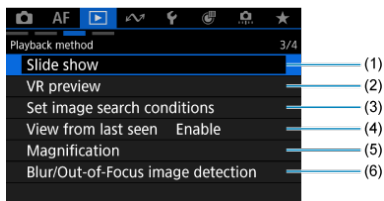

- (1) [Slide show](#)
- (2) [VR preview](#)
- (3) [Set image search conditions](#)
- (4) [View from last seen](#)
- (5) [Magnification](#)
- (6) [Blur/Out-of-Focus image detection](#)

● Various settings

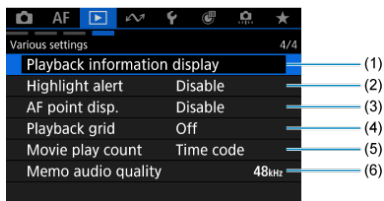

- (1) [Playback information display](#)
- (2) [Highlight alert](#)
- (3) [AF point disp.](#)
- (4) [Playback grid](#)
- (5) [Movie play count](#)
- (6) [Memo audio quality](#)

Image Playback

[Single-Image Display](#)

[Shooting Information Display](#)

[Touch Playback](#)

Single-Image Display

1. Switch to playback.



- Press the <  > button.
- The last image captured or played back is displayed.

2. Browse images.

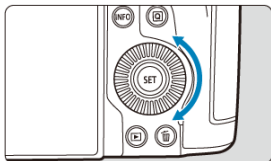

- Turn the <  > dial to browse images. Movies and still photos are displayed one after another regardless of which was captured first.
- Press the < **MODE** > button to play the most recent movie, or to display the still photo numbered with the highest file number and stored in the folder with the highest folder number.

- Each time you press the < INFO > button, the display will change.

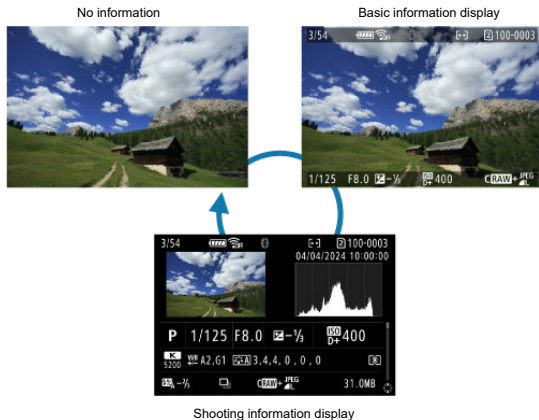

3. Exit image playback.

- Press the < ▶ > button to exit image playback and return to shooting standby.

Note

- Lines indicating the image area are shown on RAW images captured with [📷: 📷 **Cropping/aspect ratio**] set to [1:1 (aspect ratio)], [4:3 (aspect ratio)], or [16:9 (aspect ratio)] (🔗).
- If the search conditions are set with [▶: **Set image search conditions**] (🔗), only the filtered images will be displayed.
- When played back, images captured with [📷: **Add cropping information**] set to an option other than [Disable] (🔗) are displayed with lines indicating the image area.

Shooting Information Display

With the shooting information screen displayed (📄), you can press < ⌘ > up or down to view other information. You can also customize the information displayed, in [▶]: **Playback information display** (📄).

Touch Playback

The camera features a touch-screen panel that you can touch to control playback. Supported touch operations are like those used with smartphones and similar devices. First, press the <  > button to prepare for touch playback.

Browse images

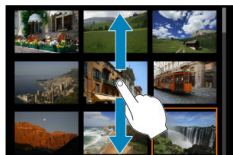

Jump display



Index display

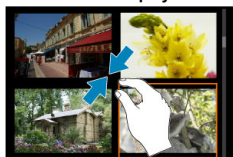

Magnified view



Note

- You can also magnify display by double-tapping with one finger.

Magnified Image Display

- ☑ [Setting the Initial Magnification Ratio](#)
- ☑ [Setting the Initial Magnification Position](#)
- ☑ [Magnification for Subsequent Images](#)

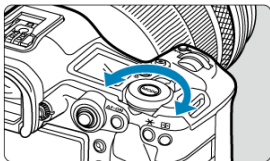

You can magnify display of your captured images.

1. Magnify the image.



- Turn the dial clockwise.



- The magnified view will appear. The position of the magnified area (1) is displayed in the lower right of the screen, along with [].
- To magnify images, turn the dial clockwise.
- To reduce magnification, turn the dial counterclockwise. For index display (

2. Scroll the image.

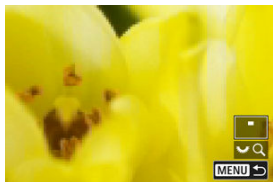
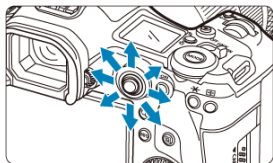

- Use < * > to scroll around the magnified image.
- Press the < Q > or < MENU > button to exit magnified view.

Note

- To switch to other images while maintaining magnified view, turn the <  > dial.
- Magnification is not available for movies.
- You can also magnify images by pressing < * > straight in, which has the same effect as the < Q > button.

Setting the Initial Magnification Ratio

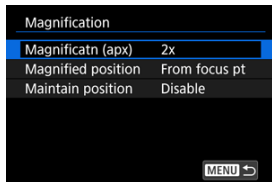

You can set the initial magnification ratio.

1. Select [: Magnification] ()
2. Select [Magnificatn (apx)].

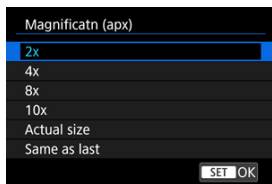

3. Select an option.



- **2x, 4x, 8x, 10x**
Magnified view starts at the selected magnification ratio.
- **Actual size**
Displays images essentially full-size, based on their pixels.
- **Same as last**
Magnified view resumes from the same ratio as the last time you exited magnified view with the <  > or <  > button.

Setting the Initial Magnification Position

You can set the initial magnification position.

1. Select [▶: Magnification] (🔗).
2. Select [Magnified position].

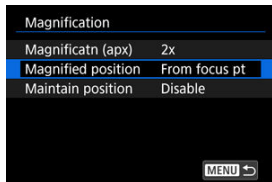

3. Select an option.

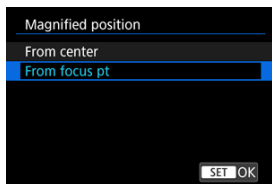

- **From center**
Magnified view starts from the center of the screen.
- **From focus pt**
Magnified view starts from the AF point in focus. If the photo is taken with manual focus, the magnified view starts from the center of the screen.

Magnification for Subsequent Images

You can specify whether to maintain the same position for magnified view or to use the position set in **[Magnified position]** when displaying subsequent images.

1. Select **[▶: Magnification] (Ⓜ)**.

2. Select **[Maintain position]**.

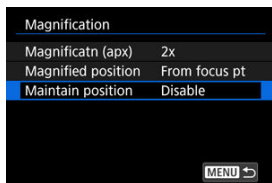

3. Select an option.

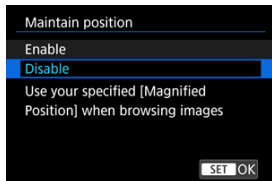

- **Enable**
The current magnified position is maintained when displaying subsequent images in magnified view.
- **Disable**
The position set in **[Magnified position]** is used when displaying subsequent images in magnified view.

Index Display (Multiple-Image Display)

1. Press the <Q> button.



- During image playback, press the <Q> button.
- [👁️Q] will be displayed in the lower right of the screen.

2. Switch to the index display.

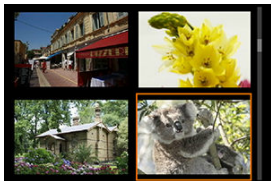
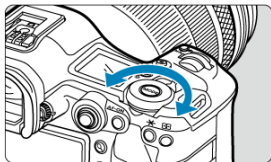

- Turn the <👁️> dial counterclockwise.
- The 4-image index display will appear. The selected image is highlighted with an orange frame.
- Turning the <👁️> dial further counterclockwise will switch the display from 9 to 36 to 100 images. Turning the dial clockwise cycles through 100, 36, 9, 4, and single-image display.

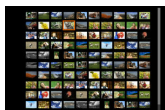
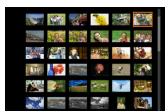
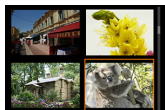

3. Browse images.



- Use < * > or the < ⌚ > dial to move the orange frame for image selection.
- Press < SET > in the index display to display the selected image in the single-image display.

Voice Memo Recording and Playback

 [Recording Voice Memos](#)

 [Memo Audio Quality](#)

 [Playing Voice Memos](#)

You can add (record) voice memos to your shots. Voice memos are recorded as WAV audio files with the same file number as the image. They can be played back by the camera or a computer.

Recording Voice Memos

1. Switch to playback.
2. Select an image to add a voice memo to.
 - Turn the <  > dial to select an image to add a voice memo to.

3. Record a voice memo.

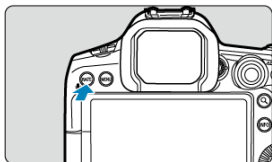

- Hold down the < **RATE** > button for approx. 2 sec.

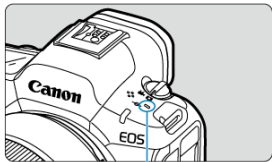

(1)

- Keep holding down the button after [**Recording memo...**] appears, and speak into the microphone (1). Each recording can be up to approx. 30 sec.
- To end the voice memo, release the button.



- A [] icon is displayed at the top of the screen.

 **Caution**

- Voice memos cannot be added to movies.
- Voice memos cannot be recorded with an external microphone.
- Voice memos cannot be added to images during transfer to an FTP server.

 **Note**

- Audio quality of voice memo recording can be changed in []: **Memo audio quality**].
- To record voice memos longer than 30 sec., repeat step 3.
- You can record a single voice memo during image review (immediately after shooting) by following step 3.

Memo Audio Quality

You can set the audio quality for recording voice memos.

1. Select [**▶**: Memo audio quality] (**ⓧ**).
2. Select an option.

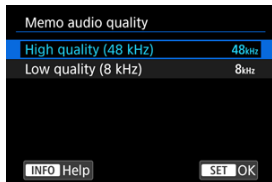

- **High quality (48 kHz)**
Enables voice memo recording at the same level of audio quality as movies.
- **Low quality (8 kHz)**
Enables smaller voice memo file sizes than with [**High quality (48 kHz)**].

! Caution

- Additional voice memo recording for images with existing voice memos is performed at the same level of audio quality as the first recording, regardless of this setting.

Playing Voice Memos

This example is based on assigning voice memo playback to the < **RATE** > button (🔍).

1. Assign [▶/🎤] to the < **RATE** > button.

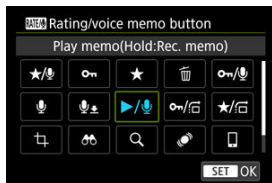

- Select [**Play memo(Hold:Rec. memo)**], then press < 🔍 >.

2. Select an image for voice memo playback.



- Press the < ▶ > button to switch to image playback.
- Turn the < 🔍 > dial to select an image labeled with a [🔍] icon at the top of the screen.

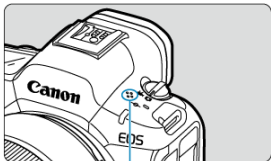
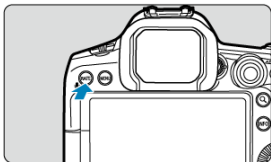

3. Play back the voice memo.



(2)

- Press the < **RATE** > button to play back the voice memo through the speaker (2).
- You can adjust the sound volume by turning the <  > dial.
- To stop playback, press the < **RATE** > button.

Note

- Multiple voice memos added to an image are played back consecutively.
- Erasing images () also erases any voice memos added to the images.
- A voice memo added to an image can be erased without erasing the image ()

Movie Playback

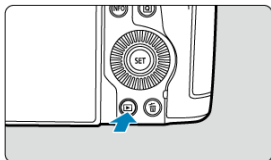

1. Switch to playback.

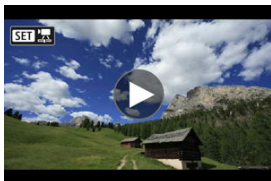

- Press the <  > button.

2. Select a movie.



- Turn the <  > dial to select a movie to play.
- In single-image display, the [**SET** ] icon displayed in the upper left of the screen indicates a movie.



- In index display, perforations at the left edge of a thumbnail indicate a movie. Movies cannot be played back from index display, so press <  > to switch to single-image display.

3. In the single-image display, press <  >.



4. Play the movie.

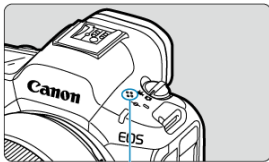

- Press <  > or tap .



(1)

- The movie will start playing back. Sound is played through the speaker (1).
- You can pause playback and display the movie playback panel by pressing <  >. Press it again to resume playback.
- Turn the <  > dial to adjust the volume (even during playback).

Movie playback panel



Item	Playback Operations
Skip backward	< * > Skips backward approx. 1 sec. each time you press < * > left. Holding < * > to the left rewinds the movie.
Previous frame	Displays the previous frame each time you turn the < ⌚ > dial left.
Play	Pressing < Ⓢ > toggles between playback and stop.
Next frame	Displays the next frame each time you turn the < ⌚ > dial right.
Skip forward	< * > Skips forward approx. 1 sec. each time you press < * > right. Holding < * > to the right fast-forwards the movie.
	Playback position
hh:mm:ss	Playback time (hours:minutes:seconds, when [Movie play count] is set to [Rec time])
hh:mm:ss.ff (DF) hh:mm:ss:ff (NDF)	Time code (hours:minutes:seconds:frames, when [Movie play count] is set to [Time code])
Volume	Turn the < ⌚ > dial to adjust the speaker volume (🔊). You can also adjust the volume by pressing < * > vertically.
	Press the < Q > button to go to the next screen (🔍).
	Press the < MENU > button to return to single-image display.



Controls not on the previous screen are as follows.

Item	Playback Operations
Slow motion	Adjust the slow motion speed by turning the < > dial. The slow motion speed is indicated in the upper right of the screen.
Frame Grab	Available when you play 4K or 8K movies. Enables you to extract the current frame and save it as a JPEG or HEIF still image ().
MENU	Press the < MENU > button to return to the previous screen.

Caution



- Adjust the volume using television controls when the camera is connected to a television for movie playback () , because volume cannot be adjusted by pressing < > up or down.
- Movie playback may stop if the card's read speed is too slow or movie files have corrupted frames.

4K/8K Movie Frame Grab

From 4K or 8K movies, you can select individual frames to save as JPEG or HEIF still images. This is referred to as “frame grabbing.”

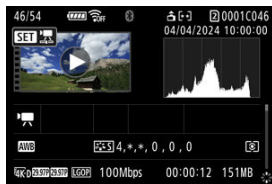
1. Select a 4K or 8K movie.



- Turn the <  > dial to select a movie in 4K or 8K quality.
- In index display, press <  > to switch to single-image display.

2. In the single-image display, press < >.

- The movie playback panel will appear.

3. Select a frame to grab.



- Use the movie playback panel to select the frame to grab as a still image.
- For movie playback panel instructions, see [Movie playback panel](#).

4. Press the < Q > button.

5. Select [Still Image].



6. Save.

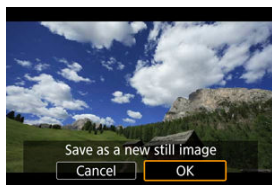

- Select [OK] to save the current frame as a JPEG still image.
- HEIF images are saved if you grab frames from movies recorded with [Camera: HDR shooting (PQ)] set to [HDR PQ].
- Check the destination folder and image file number.

7. Select the image to display.

- Select [View original movie] or [View extracted still image].

 **Caution**

- Frame grabbing is not possible from the following 4K movies, or from 8K movies.
 - RAW movies
 - Movies recorded with [: **Custom Picture**] set
 - Movies recorded with other cameras
- Frame grabbing is not possible while the camera is connected to a computer.

Playback on a TV Set

By connecting the camera to a television with a commercially available HDMI cable, you can play back the captured still photos and movies on the television.

If the image does not appear on the TV screen, confirm that [**F**: System frequency] is correctly set to [59.94Hz:NTSC] or [50.00Hz:PAL] (depending on the video system of your television).

1. Connect the HDMI cable to the camera.

- Use the cable protector (🔒) and insert the HDMI cable in the camera's < **HDMI OUT** > terminal.

2. Connect the HDMI cable to the television.

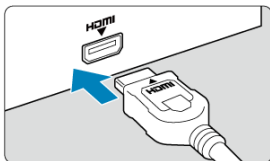

- Connect the HDMI cable to the television's HDMI IN port.

3. Turn on the television and switch the television's video input to select the connected port.

4. Set the camera's power switch to < ON >.

5. Press the <  > button.

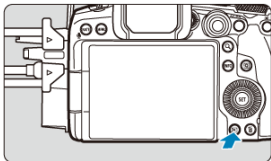



- Images are now displayed on the television, with nothing displayed on the camera screen.
- The images will automatically be displayed at the optimum resolution matching the connected television.

 **Caution**

- Adjust movie sound volume with the television. The sound volume cannot be adjusted with the camera.
- Before connecting or disconnecting the cable between the camera and television, turn off the camera and television.
- Depending on the television, part of the image displayed may be cut off.
- Do not connect any other device's output to the camera's < **HDMI OUT** > terminal. Doing so may cause a malfunction.
- Certain televisions may not display the images due to incompatibility.
- It may take some time before images are displayed if the card contains movies recorded with different settings, even if you change the [: **HDMI resolution**] setting.
- Touch-screen operations are not supported while the camera is connected to a television.

 **Note**

- It may take some time before images are displayed. To avoid delay, set [: **HDMI resolution**] to an option other than [**Auto**] (). Note that if the card contains movies recorded with different settings, it may take some time before images are displayed.

Protecting Images

[✔ Protecting Individual Images via the Menu](#)

[✔ Specifying the Range of Images to Protect](#)

[✔ Protecting All Images in a Folder or on a Card](#)

You can protect important images from being accidentally erased.

! Caution

- If you format the card (🗑️), the protected images will also be erased.

📄 Note

- Once an image is protected, it cannot be erased by the camera's erase function. To erase a protected image, you must first cancel the protection.
- If you erase all the images (🗑️), only the protected images will remain. This is convenient when you want to erase all unneeded images at once.
- Voice memos can be added to protected images. For images with existing voice memos, additional voice memo recording is also possible.

Protecting Individual Images via the Menu

1. Select [📷: Protect images] (🔒).
2. Select [Select images].

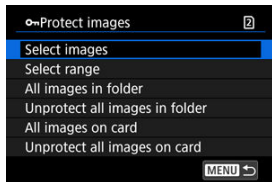





3. Select the image to protect.

- Turn the <  > dial to select an image to protect.

4. Protect the image.



- Press <  > to protect the selected image, after which it will be labeled with a  icon (1) at the top of the screen.
- To cancel protection and clear the  icon, press <  > again.
- To protect another image, repeat steps 3 and 4.

Specifying the Range of Images to Protect

While looking at the images in the index display, you can specify the first and last images for a range to protect all the specified images at once.

1. Select [Select range].

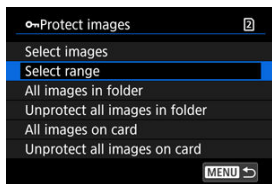

- Select [Select range] in []: Protect images].

2. Specify the range of images.

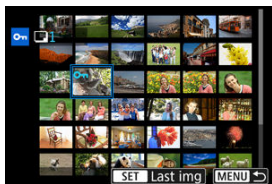

- Select the first image (start point).
- Next, select the last image (end point). The images in the specified range will be protected and the [] icon will appear.
- To select another image to protect, repeat step 2.

Protecting All Images in a Folder or on a Card

You can protect all the images in a folder or on a card at once.

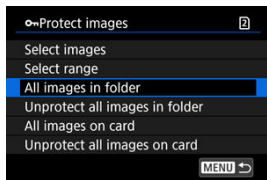

- When you select **[All images in folder]** or **[All images on card]** in **[]: Protect images**, all the images in the folder or on the card will be protected.
- To cancel protection, select **[Unprotect all images in folder]** or **[Unprotect all images on card]**.
- If the search conditions are set with **[]: Set image search conditions** (🔍), the display will change to **[All found images]** and **[Unprotect all found]**.

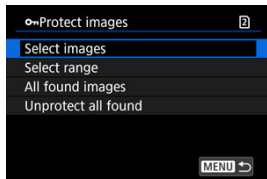

- If you select **[All found images]**, all the images filtered by the search conditions will be protected.
- If you select **[Unprotect all found]**, the protection of all the filtered images will be canceled.

Note

- Protecting or unprotecting images by selecting **[All images on card]** or **[Unprotect all images on card]** applies to the card selected in **[📁: Record func+card/folder sel.]** (in either **[📷 Record/play]/[📷 Record/play]** or **[📷 Play]/[📷 Play]**).

Erasing Images



- [Erasing Images Individually](#)
- [Selecting \(\[✓\]\) Multiple Images to Erase Together](#)
- [Specifying the Range of Images to Erase](#)
- [Erasing All Images in a Folder or on a Card](#)

You can either select and erase unnecessary images individually or erase them in one batch. Protected images (🔒) will not be erased.

⚠ Caution

- Once an image is erased, it cannot be recovered. Make sure you no longer need the image before erasing it. To prevent important images from being erased accidentally, protect them.

Erasing Images Individually

1. Press the <  > button.
2. Select the image to be erased.
 - Turn the <  > dial to select the image to erase.
3. Press the <  > button.



4. Erase the images.

JPEG/HEIF/RAW images or movies

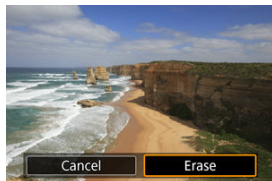

- Select **[Erase]**.

RAW+JPEG/RAW+HEIF images



- Select an option.
- For images with voice memos, you can also erase just the voice memo during image playback by selecting **[Erase voice memo]**.
- Series of images captured in **[Q4]**, **[Q5H]**, or **[Q5]** drive mode are erased when you select **[Erase scene including image]** during playback.

Selecting ([✓]) Multiple Images to Erase Together

By adding checkmarks to the images to be erased, you can erase all those images at once.

1. Select [▶]: Erase images] (☑).
2. Select [Select and erase images].

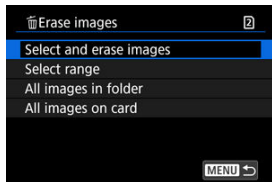

3. Select an image.



- Turn the <⦿> dial to select an image to erase, then press <Ⓢ>.
- To select another image to be erased, repeat step 3.

4. Press the <[Q]> button.

5. Erase the images.

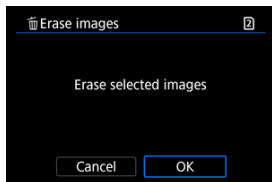

- Select **[OK]**.

Specifying the Range of Images to Erase

While looking at the images in the index display, you can specify the first and last images for a range to erase all the specified images at once.

1. Select [Select range].

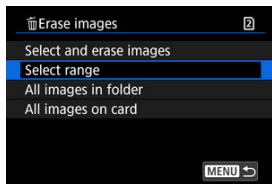

- Select [Select range] in [▶]: Erase images].

2. Specify the range of images.



- Select the first image (start point).
- Next, select the last image (end point). A checkmark [✓] will be appended to all the images within the range between first and last images.
- To select another image to be erased, repeat step 2.

3. Press the <Q> button.

4. Erase the images.

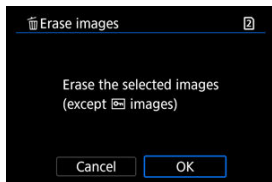

- Select **[OK]**.

Erasing All Images in a Folder or on a Card

You can erase all the images in a folder or on a card at once.

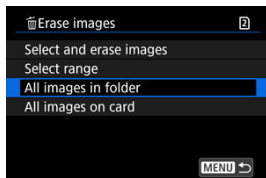

- When you select **[All images in folder]** or **[All images on card]** in **[MENU]: Erase images**, all the images in the folder or on the card will be erased.
- If the search conditions are set with **[MENU]: Set image search conditions** (🔍), the display will change to **[All found images]**.

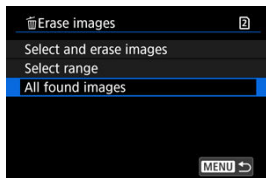

- If you select **[All found images]**, all the images filtered by the search conditions will be erased.

Note

- To erase all the images including protected images, format the card (🔗).
- Erasing images by selecting **[All images on card]** applies to the card selected in **[FUNC: Record func+card/folder sel.]** (in either **[CAMERA Record/play]/[RECORDING Record/play]** or **[CAMERA Play]/[RECORDING Play]**).

Rotating Still Photos

You can use this feature to rotate the displayed image to the desired orientation.

1. Select []: Rotate stills] ().

2. Select an image to rotate.

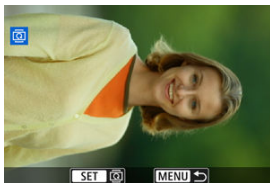

- Turn the < > dial to select the image.



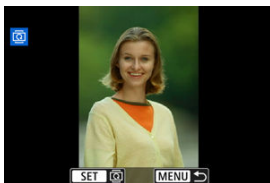

3. Rotate the image.



- Each time you press < SET >, the image will rotate clockwise as follows: 90°→270°→0°.
- To rotate another image, repeat steps 2 and 3.



Note

- If you set [**⚙**: **Auto rotate**] to [**On**  ] () before taking pictures, you need not rotate the image with this function.
- If the rotated image is not displayed in the rotated orientation during image playback, set [**⚙**: **Auto rotate**] to [**On**  ].
- Movies cannot be rotated.

Changing Movie Orientation Information

You can manually edit movie playback orientation information (which determines which side is up).

1. Select [▶]: Change mov rotate info] (🔍).
2. Select a movie.

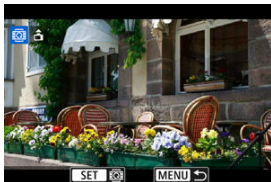

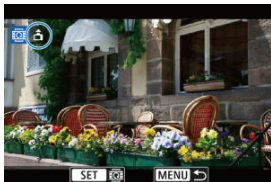

- Turn the <⊙> dial to select a movie with orientation information to change.

3. Change the orientation information.



- As you watch the camera and ▲ icon in the upper left of the screen, press <SET> to specify which side is up. Each press of <SET> edits the movie rotation information as follows: [📷] → [📷] → [📷].

 **Caution**

- Movies are played horizontally on the camera and via HDMI video output, regardless of the [: **Add**  **rotate info**] setting ().
- Movie orientation information of movies recorded with other cameras cannot be edited with this camera.

Rating Images

[Rating Individual Images with the < RATE > Button](#)

[Rating Individual Images via the Menu](#)

[Rating by Specifying the Range](#)



[Rating All Images in a Folder or on a Card](#)

You can rate images on a scale of 1–5 ([*] / [**] / [**] / [***] / [****]). This function is called rating.

* Rating images can help you organize them.

Rating Individual Images with the < RATE > Button

1. Select the image to be rated.

- Press the <  > button to switch to image playback.
- Turn the <  > dial to select the image to rate.

2. Rate the image.



- Press the < **RATE** > button to rate the image.
- To rate another image, repeat steps 1 and 2.

Rating Individual Images via the Menu

1. Select [▶]: Rating) (☑).
2. Select [Select images].

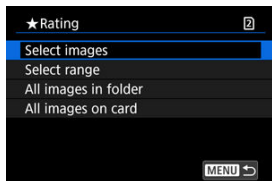



3. Select the image to be rated.



- Turn the <⦿> dial to select the image to be rated.

4. Rate the image.



- Press <  >, and a blue highlight frame will appear as shown in the screen shown above.
- Turn the <  > dial to select a rating mark, then press <  >.
- When you append a rating mark to the image, the number beside the set rating will increase by one.
- To rate another image, repeat steps 3 and 4.

Rating by Specifying the Range

While looking at the images in the index display, you can specify the first and last images for a range to rate all the specified images at once.

1. Select [Select range].

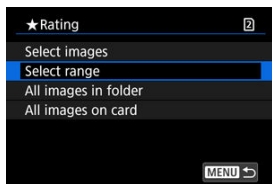

- Select [Select range] in []: Rating.

2. Specify the range of images.



- Select the first image (start point).
- Next, select the last image (end point). A checkmark [✓] will be appended to all the images within the range between first and last images.
- To select other images, repeat step 2.

3. Press the < [Q] > button.

4. Rate the image.



- Turn the <  > dial to select a rating mark, then select **[OK]**. All the images in the specified range will be rated (same rating) at once.

Rating All Images in a Folder or on a Card

You can rate all the images in a folder or on a card at once.

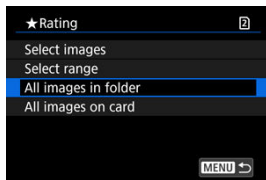

- Under **[▶]: Rating**, when you select **[All images in folder]** or **[All images on card]**, all the images in the folder or on the card will be rated.



- Turn the **< [Sun] >** dial to select a rating, then select **[OK]**.
- When you are not rating images or canceling the rating, select **[OFF]**.
- If the search conditions are set with **[▶]: Set image search conditions** **[☑]**, the display will change to **[All found images]**.

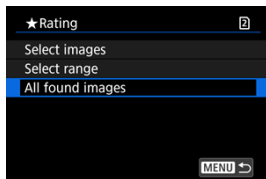

- If you select **[All found images]**, all the images filtered by the search conditions will be rated as specified.



Note

- Values next to ratings are displayed as [###] if more than 1,000 images have that rating.
- With [▶]: **Set image search conditions**] and [🔍: **Image jump w/** 🌅], you can display only the images given a specific rating.

Copying Still Photos



 [Copying Individual Images](#)

 [Copying a Range of Images](#)





 [Copying All Images in a Folder or on a Card](#)

You can copy the images on one card to the other card to save duplicates.
All images in a folder or on a card can also be copied at the same time.

Caution

- Movies recorded by this camera cannot be copied.
 - For extensive copying, consider using a household power outlet accessory (sold separately).
 - If the target folder or card already has an image with the same file number, **[Skip image and continue]**, **[Replace existing image]**, and **[Cancel copy]** are displayed. Select a copying method, then press <  >.
 - **[Skip image and continue]**: Any images with the same file number are skipped and not copied.
 - **[Replace existing image]**: Any images with the same file number (including protected images) are overwritten.
- Overwriting images that had print order information () will require you to set the print order information again.
- Print order and image transfer information is not included in copies of images.
 - Shooting is not possible during the copying process. Select **[Cancel]** before shooting.

Note

- Images are copied from the card selected in [ **Record func+card/folder sel.**] (in either [ **Record/play**]/[ **Record/play**] or [ **Play**]/[ **Play**]).
- Copies of images have the same file name as the original image.
- With **[Sel.Image]**, images in multiple folders cannot be copied at the same time. Select images to copy from one folder at a time.
- Any voice memos added to images are also copied.

Copying Individual Images

1. Select [▶]: [📷 Image copy] (🔗).
2. Select [Sel.Image].

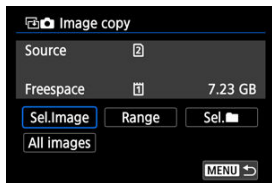

- Check the source and target card numbers and the free space on the target card.
- Select [Sel.Image], then press <ⓈET>.

3. Select the folder.

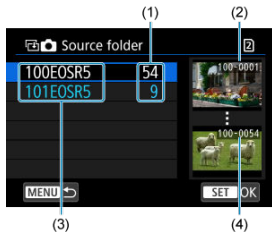



- (1) Number of images in folder
- (2) Lowest file number
- (3) Folder name
- (4) Highest file number

- Select the source folder, then press <ⓈET>.
- When selecting the folder, refer to the images displayed at right of the screen.

4. Select an image to copy.



(1) Total images selected

- Turn the <  > dial to select an image to copy, then press <  >.
- To select another image to copy, repeat step 4.

5. Press the <  > button.

6. Select [OK].

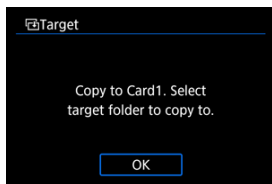

- Check the target card, then select [OK].

7. Select the target folder.

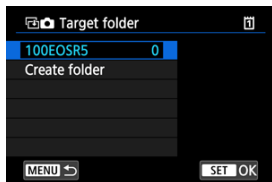

- Select the folder to copy the image to, then press < (SET) >.
- To create a new folder, select **[Create folder]**.

8. Select [OK].

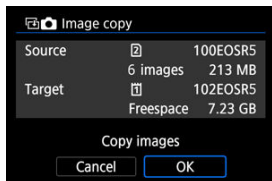

- Check the information about the source and target card, then select **[OK]**.

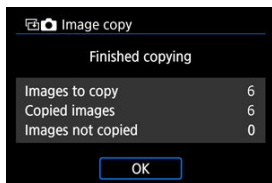

- Results are displayed after copying is finished. Select **[OK]** to return to the screen in step 2.

Copying a Range of Images

You can copy all specified images at once by selecting the first and last images in a range as you look at images in the index display.

1. Select [Range].

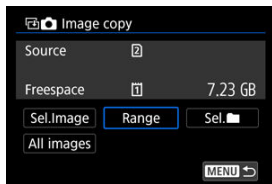

2. Select the folder.

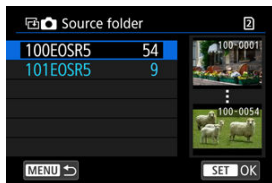

- Select the source folder, then press < (SET) >.
- When selecting the folder, refer to the images displayed at right of the screen.

3. Specify the range of images.



- Select the first image (start point).
- Next, select the last image (end point). A checkmark [✓] will be appended to all the images within the range between first and last images.
- To select another image to copy, repeat step 3.

4. Press the <Q> button.

- Images in the specified range are now copied.

Copying All Images in a Folder or on a Card

You can copy all the images in a folder or on a card at once.

Selecting [Sel. ] or [All images] in []:  Image copy] copies all the images it contains.

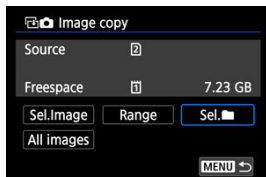

Print Ordering (DPOF)



 [Setting Print Options](#)

 [Selecting Images for Printing](#)

DPOF (Digital Print Order Format) enables you to print images recorded on the card according to your printing instructions such as the image selection, quantity to print, etc. You can print multiple images in one batch or create a print order for a photofinisher.

You can set the print settings such as print type, date imprinting, file number imprinting, etc. The print settings will be applied to all the images specified for printing. (They cannot be set individually for each image.)

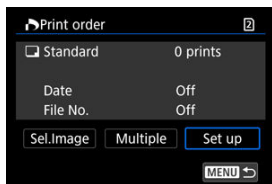

Setting Print Options

1. Select [: Print order] ().
2. Select [Set up].



3. Set the options as desired.

- Set **[Print type]**, **[Date]**, and **[File No.]** options.

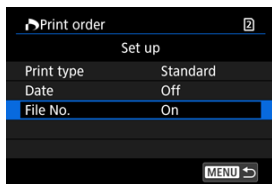

Print type	 Standard	Prints one image on one sheet.
	 Index	Multiple thumbnail images are printed on one sheet.
	 Both	Prints both the standard and index prints.
Date	On	[On] imprints the recorded date of the captured image.
	Off	
File No.	On	[On] imprints the file number.
	Off	

4. Exit the setting.



- Press the < **MENU** > button.
- Next, select **[Sel.Image]** or **[Multiple]** to specify the images to be printed.

 **Caution**

- If you print an image with a large image size using the **[Index]** or **[Both]** setting () , the index print may not be printed with certain printers. In this case, resize the image () , then print the index print.
- Even if **[Date]** and **[File No.]** are set to **[On]**, the date or file number may not be imprinted, depending on the print type setting and printer.
- With **[Index]** prints, the **[Date]** and **[File No.]** cannot both be set to **[On]** at the same time.
- When printing with DPOF, use the card for which print order specifications are set. You cannot print in the specified print order if you extract just the images from the card for printing.
- Certain DPOF-compliant printers and photofinishers may not be able to print the images as you specified. When using a printer, refer to the printer's instruction manual. When requesting service from a photofinisher, ask in advance.
- Do not use this camera to configure print settings for images with DPOF settings set up on another camera. All the print orders may be overwritten inadvertently. Also, the print order may not be possible, depending on the image type.

Selecting Images for Printing

Selecting images

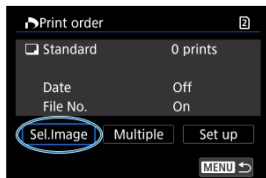

Select and specify the images individually.

Press the < MENU > button to save the print order to the card.

● Standard/Both

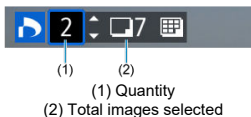

Press < SET > to print a copy of the displayed image. By turning the < dial >, you can set a print quantity of up to 99 copies.

● Index

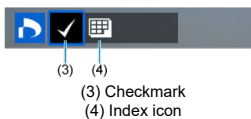

Press < SET > to add a checkmark [✓] to the box. The image will be included in the index print.

Selecting multiple images

- **Select range**

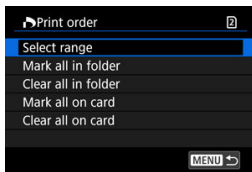

Select **[Select range]** in **[Multiple]**. Selecting the first and last images of the range marks all the images in the range with a checkmark [✓], and one copy of each image will be specified for printing.

- **All images in a folder**

Select **[Mark all in folder]** and select the folder. A print order for one copy of all the images in the folder will be specified.

If you select **[Clear all in folder]** and select the folder, the print order for all the images in the folder will be canceled.

- **All images on a card**

If you select **[Mark all on card]**, one copy of all the images on the card will be specified for printing.

If you select **[Clear all on card]**, the print order will be cleared for all the images on the card.

If the search conditions are set with **[▶]: Set image search conditions** (🔍) and you select **[Multiple]**, the display will change to **[Mark all found images]** and **[Clear all found images]**.

- **All found images**

If you select **[Mark all found images]**, one copy of all the images filtered by the search conditions will be specified for printing.

If you select **[Clear all found images]**, all the print order of the filtered images will be cleared.

⚠ Caution

- RAW/HEIF images and movies cannot be specified for printing. Note that RAW/HEIF images and movies will not be specified for printing even if you specify all images with **[Multiple]**.

RAW Image Processing



- [Magnified View](#)
- [Processing Images with Specified Aspect Ratios](#)
- [RAW Image Processing Options](#)

You can process **RAW** or **CRAW** images with the camera to create JPEG or HEIF images. RAW images are not affected, so different conditions can be applied to create JPEG or HEIF images.

You can also use Digital Photo Professional (EOS software) to process RAW images.

Caution

- Processing into HEIF is not available for **RAW** or **CRAW** images captured with expanded ISO speed (L or H).

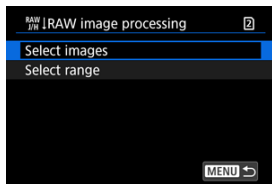

1. Select [: RAW image processing] ().
2. Select an option.



- You can select multiple images to process at once.

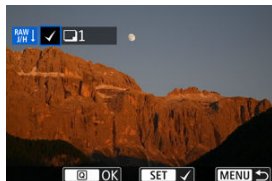

Select images



- Turn the <  > dial to select images to process, then press <  >.
- Press the <  > button.

Select range



- Select the first image (start point).
- Next, select the last image (end point). A checkmark [] will be appended to all the images within the range between first and last images.
- To process other images, repeat this step.
- Press the <  > button.

3. Set the desired processing conditions.

Use shot settings

- Images are processed using image settings at the time of capture.
- Images captured with [CAMERA]: [HDR shooting (PQ)] set to [HDR PQ] are processed to create HEIFs, and images captured with this function set to [Disable] are processed to create JPEGs.

Set up processing → JPEG/Set up processing → HEIF



- Use < > to select an item.
- Turn the < > or < > dial to switch the setting.
- Press < > to access the function setting screen.
- To return to the image settings at the time of shooting, press the < > button.

Comparison screen

- You can switch between the [After change] and [Shot settings] screens by pressing the < INFO > button and turning the < > dial.
- Items in orange on the [After change] screen have been modified since the time of capture.
- Press the < MENU > button to return to the processing conditions screen.

4. Save.

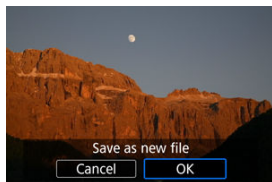

- When using [Set up processing→JPEG] or [Set up processing→HEIF], select [⌘S] (Save).
- Read the message and select [OK].
- If there are other images for processing, select [Yes].

5. Select the image to display.

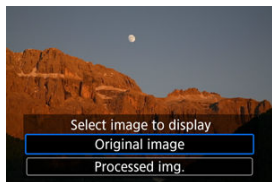

- Select [Original image] or [Processed img.].
- Your selected image is displayed.



Magnified View

You can magnify images displayed for **[Set up processing→JPEG]** or **[Set up processing→HEIF]** by pressing the <Q> button. The magnification ratio varies depending on the **[Image quality]** setting. With <⌘>, you can scroll around the magnified image. To cancel the magnified view, press the <Q> button again.

⚠ Caution

- Results of processing under the following settings are only applied in magnified view. Results are not applied in normal display.
 - **[Digital Lens Optimizer]** set to **[High]**
 - **[Neural network Noise Reduction]** set to **[Enable]**

Processing Images with Specified Aspect Ratios

JPEG or HEIF images at the specified aspect ratio are created when you process RAW images shot with [: Cropping/aspect ratio] () set to [1:1 (aspect ratio)], [4:3 (aspect ratio)], or [16:9 (aspect ratio)].

RAW Image Processing Options

- ±0: **Brightness adjustment**

You can adjust the image brightness up to ±1 stop in 1/3-stop increments.

- : **White balance** (🔗)

You can select the white balance. Selecting enables you to select **[Auto: Ambience priority]** or **[Auto: White priority]**. If you select , you can set the color temperature.

- : **Picture Style** (🔗)

You can select the Picture Style. You can adjust the sharpness, contrast, and other parameters.

* , , , and are not available when **[Set up processing→HEIF]** is set.

- ±0: **Clarity** (🔗)

You can adjust clarity in a range of -4 to +4.

* Not available when **[Set up processing→HEIF]** is set.

- : **Auto Lighting Optimizer** (🔗)

You can set the Auto Lighting Optimizer.

- : **Adj face lighting**

With automatic, optimal adjustment of lighting on faces, you can effectively correct images captured with oblique lighting or illuminated by flash.

* Adjustment of face lighting is not available when **[Set up processing→HEIF]** is set.

Caution

When adjustment of face lighting is set

- Suitable adjustment may not be possible in some shooting situations unless faces can be detected in detail and are not too dark.
- Noise may increase.
- Adjustment may be less effective at high ISO speeds.

- **NR_H**: High ISO speed NR (🔍)

You can set the noise reduction processing for high ISO speeds. If the effect is difficult to discern, magnify the image (🔍).

- **NR_{OFF}**: Neural network Noise Reduction

You can obtain clearer images with less noise through noise reduction processing that applies deep learning.

⚠ Caution

- Processing with Neural network Noise Reduction may take some time.

- **L**: Image quality (🔍)

You can set the image quality when creating a JPEG or HEIF image.

- **sRGB**: Color space (🔍)

You can select either sRGB or Adobe RGB. Since the camera screen is not compatible with Adobe RGB, the difference in the image will hardly be perceptible when either color space is set.

* **[HDR PQ]** is displayed when **[Set up processing→HEIF]** is set but is not an option for selection.

- **||D**: Lens aberr correction

- OFF: Peripheral illum corr (🔍)

A phenomenon that makes the image corners look darker due to the lens characteristics can be corrected. If **[Enable]** is set, the corrected image will be displayed. If the effect is difficult to discern, magnify the image (🔍) and check the four corners. Less correction is applied than for maximum correction with Digital Photo Professional (EOS software, 🔍). If the effects of correction are not apparent, use Digital Photo Professional to apply the peripheral illumination correction.

- OFF: Distortion correction (🔍)

Image distortion due to lens characteristics can be corrected. If **[Enable]** is set, the corrected image will be displayed. The image periphery will be trimmed in the corrected image.

Since the image resolution may look slightly lower, adjust the sharpness with the Picture Style's sharpness parameter setting as necessary.

 OFF: **Digital Lens Optimizer** 

Correct lens aberration, diffraction, and low-pass filter-induced loss of resolution by applying optical design values. To check the effect of setting this option to **[High]** or **[Standard]**, use magnified view . Without magnification, the effect when Digital Lens Optimizer is set to **[High]** is not applied. Selecting **[High]** or **[Standard]** processes images as if both chromatic aberration and diffraction were set to **[Enable]**, although these options are not displayed.

 OFF: **Chromatic aberr corr** 

Chromatic aberrations (color fringing along the subject's outline) due to the lens characteristics can be corrected. If **[Enable]** is set, the corrected image will be displayed. If the effect is difficult to discern, magnify the image .

 OFF: **Diffraction correction** 

The diffraction by the lens aperture degrading the image sharpness can be corrected. If **[Enable]** is set, the corrected image will be displayed. If the effect is difficult to discern, magnify the image .

 **Caution**

- Processing RAW images in the camera will not produce exactly the same results as processing RAW images with Digital Photo Professional (EOS software).
- If you perform **[Brightness adjustment]**, noise, banding, etc. may be intensified with the effects of adjustment.
- When **[Digital Lens Optimizer]** is set, noise may be intensified together with the effects of correction.
- When **[Digital Lens Optimizer]** is set, image edges may be emphasized, under some shooting conditions. Adjust sharpness of the Picture Style as needed.
- Processing with **[Digital Lens Optimizer]** set to **[High]** may take some time.

 **Note**

- Effects of lens aberration correction vary by lens and shooting conditions. Also, the effect may be difficult to discern depending on the lens used, shooting conditions, etc.
- RAW movies cannot be processed. Process them with Digital Photo Professional (EOS software).



In-Camera Upscaling

[Converting Individual Images](#)

[Specifying the Range of Images to Convert](#)

This deep-learning processing can double the vertical and horizontal pixel counts and quadruple the total pixel count of your JPEG or HEIF images. Upscaling is available for images captured as JPEGs or HEIFs with an image size of **L**.

Caution

- Image processing may take some time.
- Shooting is not possible until processing is finished.
- These images cannot be upscaled.
 - Images captured with [:  **Cropping/aspect ratio**] set to an option other than [**Full-frame**]
 - RAW images
 - Images from cameras other than an EOS R5 Mark II
 - Images already upscaled
 - Images processed on a camera or in editing software (resized, cropped, or extracted)
- The effect may not look as expected for images from some shooting situations.

Note

- Upscaled images are labeled [].
- Upscaled images are saved in the same format (JPEG or HEIF) as the original image.

Converting Individual Images

1. Select [▶]: [In-Camera Upscaling] (Q).

2. Select [Select images].

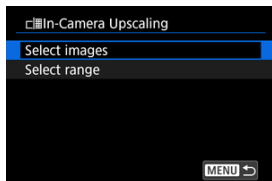

3. Select an image.

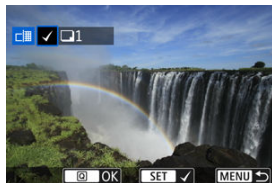

- Turn the <◉> dial to select an image to upscale, then press <SET>.
- To select another image to upscale, repeat step 3.
- Press the <Q> button to execute upscaling.

4. Save.

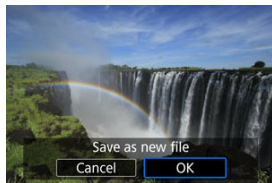

- Select **[OK]** to save the upscaled image.
- If there are other images for conversion, select **[Yes]**.

5. Select the image to display.



- Select **[Original image]** or **[Processed img.]**.
- Your selected image is displayed.

Specifying the Range of Images to Convert

1. Select [Select range].

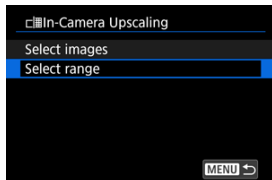

2. Specify the range of images.

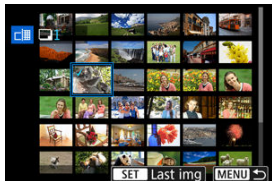

- Select the first image (start point).
- Next, select the last image (end point). A checkmark [✓] will be appended to all the images within the range between first and last images.
- To select other images, repeat step 2.

3. Press the <Q> button.

4. Save.

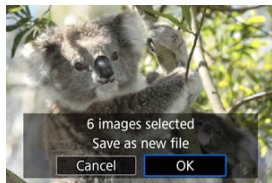

- Select [**OK**] to save the upscaled image.
- If there are other images for conversion, select [**Yes**].

5. Select the image to display.

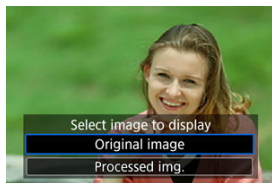

- Select [**Original image**] or [**Processed img.**].
- Your selected image is displayed.

Resizing JPEG/HEIF Images

You can resize a JPEG or HEIF image to reduce the pixel count and save it as a new image. Resizing is available for **L**, **M**, or **S1** JPEGs or HEIFs (in sizes except **S2**), including those captured in RAW+JPEG and RAW+HEIF shooting. **S2** images and RAW images or movies cannot be resized.

1. Select []: Resize] ().

2. Select an image.

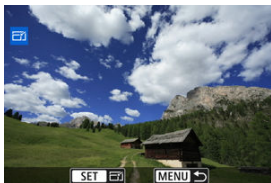

- Turn the < > dial to select the image to resize.

3. Select the desired image size.



(1)

- Press < SET > to display the image sizes.
- Select the desired image size (1).

4. Save.

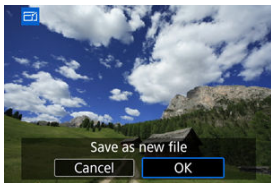

- Select [**OK**] to save the resized image.
- Check the destination folder and image file number, then select [**OK**].
- To resize another image, repeat steps 2 to 4.

Cropping JPEG/HEIF Images

You can crop a captured JPEG image and save it as another image. Cropping is available for JPEG or HEIF images. RAW images and frame-grab images from 4K or 8K movies cannot be cropped.

1. Select []: Cropping ().











2. Select an image.



- Turn the < > dial to select the image to crop.
- Press < SET > to display the cropping frame.



3. Set the cropping frame.



- The image area within the cropping frame will be cropped.
- **Resizing the cropping frame size**
Turn the <  > dial to resize the cropping frame size. The smaller the cropping frame, the more magnified the cropped image will look.
- **Correcting tilt**
You can correct image tilt by $\pm 10^\circ$. Turn the <  > dial to select , then press <  >. While checking tilt relative to the grid, turn the <  > dial (in 0.1° increments) or tap the left or right arrow (in 0.5° increments) in the upper left of the screen to correct tilt. After completing the tilt correction, press <  >.
- **Changing the cropping frame aspect ratio and orientation**
Turn the <  > dial and select . Each press of <  > changes the cropping frame aspect ratio and orientation.
- **Moving the cropping frame**
Use <  > to move the cropping frame vertically or horizontally.

4. Check the image area to be cropped.



- Turn the <  > dial to select , then press <  >. The image area to crop is displayed.

5. Save.

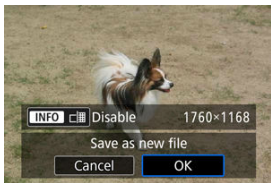

- Turn the $\langle \text{INFO} \rangle$ dial to select $[\text{INFO}]$, then press $\langle \text{SET} \rangle$.
- Select $[\text{OK}]$ to save the cropped image.
- To upscale images that will be cropped, so that they will be saved at a higher resolution, press the $\langle \text{INFO} \rangle$ button, then set $[\text{INFO}]$ to $[\text{Enable}]$ (ON) .
 - The current $[\text{INFO}]$ setting (enable/disable) is retained even after cropping, when you select other images. To change the setting, press the $\langle \text{INFO} \rangle$ button again.
 - The resulting image size after upscaling is shown to the right of $[\text{INFO}]$.
 - Image processing may take some time.
 - Shooting is not possible until processing is finished.
- Check the destination folder and image file number, then select $[\text{OK}]$.
- To crop another image, repeat steps 2 to 5.

Caution

- The position and size of the cropping frame may change depending on the angle set for tilt correction.
- Once a cropped image is saved, it cannot be cropped again or resized.
- AF point display information (ON) and Dust Delete Data (ON) will not be appended to the cropped images.
- Available aspect ratios vary depending on whether you use $[\text{INFO}]$: **Cropping** or $[\text{INFO}]$: **Add cropping information**.

Converting HEIF to JPEG

[Converting Individual Images](#)

[Specifying the Range of Images to Convert](#)

You can convert HEIF images captured in HDR shooting and save them as JPEG images.

⚠ Caution

- Some scenes may look different after conversion if the original and converted images are compared.
- Conversion is not available for upscaled or cropped images, or for frame-grab images from 4K or 8K movies.

📄 Note

- HEIF images that have been converted to JPEGs are labeled [JPEG↓].

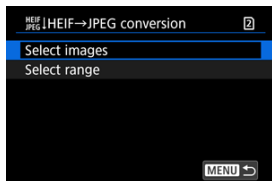

Converting Individual Images

1. Select [: HEIF→JPEG conversion] (🔗).
2. Select [Select images].

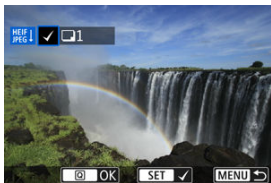

3. Select an image.



- Turn the <  > dial to select an HEIF image to convert to JPEG, then press <  >.
- To select another image to convert, repeat step 3.
- Press the <  > button to convert to JPEG.

4. Save.

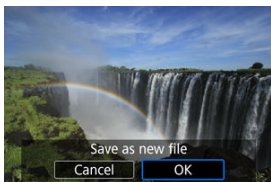

- Select [**OK**] to save the JPEG image.
- If there are other images for conversion, select [**Yes**].

5. Select the image to display.



- Select [**Original image**] or [**Processed img.**].
- Your selected image is displayed.

Specifying the Range of Images to Convert

1. Select [Select range].

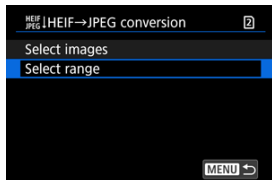

2. Specify the range of images.



- Select the first image (start point).
- Next, select the last image (end point). A checkmark [✓] will be appended to all the images within the range between first and last images.
- To select another image to convert, repeat step 2.

3. Press the < [Q] > button.

4. Save.

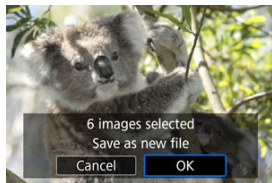

- Select **[OK]** to save the JPEG image.
- If there are other images for conversion, select **[Yes]**.

5. Select the image to display.

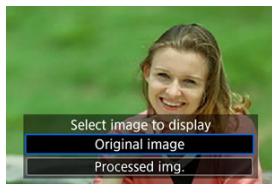

- Select **[Original image]** or **[Processed img.]**.
- Your selected image is displayed.

Slide Show

You can play back the images on the card as an automatic slide show.

1. Specify the images to be played back.

- To play back all the images on the card, go to step 2.
- To choose images for the slide show, filter the images with **[▶]: Set image search conditions** (🔗).

2. Select **[▶]: Slide show** (🔗).

3. Set the playback as desired.

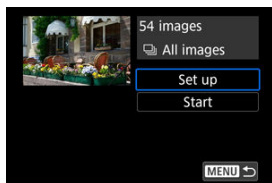

- Select [**Set up**].

Display time

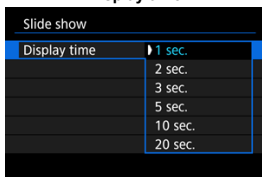

Repeat

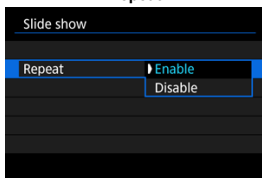

- Set the [**Display time**] and [**Repeat**] (repeated playback) settings for the still photos.
- After completing the settings, press the <MENU> button.

4. Start the slide show.

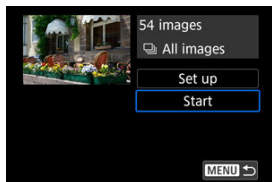



- Select [**Start**].
- After [**Loading image...**] is displayed, the slide show will start.
- All movies are played first, followed by all still photos.

5. Exit the slide show.

- To exit the slide show and return to the setting screen, press the < **MENU** > button.

Note



- To pause the slide show, press < **SET** >. During pause, [||] will be displayed in the upper left of the screen. Press < **SET** > again to resume the slide show.
- During the automatic playback of still photos, you can press the < **INFO** > button to switch the display format ().
- During movie playback, you can adjust the sound volume by turning the <  > dial.
- During auto playback or when playback is paused, you can turn the <  > dial to view another image.
- During auto playback, auto power off will not take effect.
- The display time may differ depending on the image.

VR Preview





You can check a simulated display on the camera screen of how VR content captured with lenses in the EOS VR System will appear on VR display devices.

Note

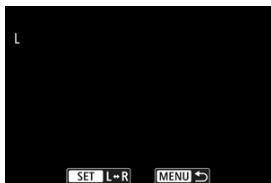









- For details on recording VR content, refer to the VR Recording Guide.

1. Select [: VR preview] ().
2. Choose a VR image.
3. Check the simulated VR display.



- To switch between left and right viewpoints of the VR content, press <  > straight in.
- To move the viewpoint, press <  > in other directions.
- To center the viewpoint again, press and hold the < **RATE** > button and press <  > straight in.
- To magnify/reduce images, turn the <  > dial.



Movie playback controls

Item	Playback Operations
 Skip backward	Skips backward approx. 1 sec. each time you press <  > left.
 Previous frame	Displays the previous frame each time you turn the <  > dial left while holding down the < RATE > button.
 Play	Pressing <  > toggles between playback and stop.
 Next frame	Displays the next frame each time you turn the <  > dial right while holding down the < RATE > button.
 Skip forward	Skips forward approx. 1 sec. each time you press <  > right.

Setting Image Search Conditions





[Clearing the Search Conditions](#)

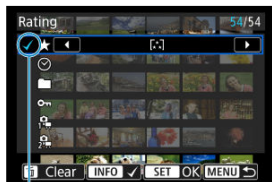





You can filter image display according to your search conditions. After setting the image search conditions, you can play back and display only the found images. You can also protect, rate, play a slide show, erase, and apply other operations to filtered images.

1. Select [: Set image search conditions] ().
2. Set the search conditions.



(1)

- Turn the < > dial to select an option.
- Turn the < > dial to set the option.
- A checkmark [] (1) is appended to the left of the option. (Specified as the search condition.)
- If you select the option and press the <INFO> button, the checkmark [] will be removed (which cancels the search condition).
- After completing the settings, press < >.

Option	Description
 Rating	Displays images with the selected (rating) condition.
 Date	Displays images taken on the selected shooting date.
 Folder	Displays images in the selected folder.
 Protect	Displays images with the selected (protect) condition.
 Type of file (1)	Displays images of the selected file type.
 Type of file (2)	

3. Apply the search conditions.

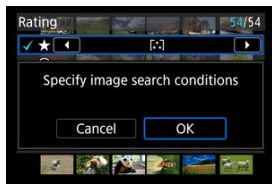

- Read the message displayed, then select [OK].
The search condition is applied.

4. Display the found images.



(2)

- Press the <  > button.
Only the images that match the set conditions (filtered) will be played back.
When the images are filtered for display, the screen will have an outer yellow frame (2).

Caution

- If no images match the search conditions, <  > cannot be pressed in step 2.
- For movies, searches apply to files in the XFVC or CRM folder.
Searching does not apply to movie files in the DCIM folder.



Note

- Search conditions may be cleared after operations involving camera power or card changes and editing, adding, or erasing images.
- Auto power off time may be extended while the [▶]: **Set image search conditions**] screen is displayed.

Clearing the Search Conditions

Access the screen in step 2, then press the <  > button to clear all the search conditions.

Resuming from Previous Playback

1. Select [▶]: View from last seen (✔).
2. Select an option.

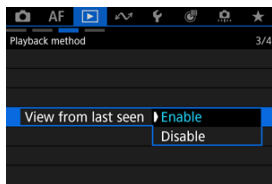

- **[Enable]**: Playback resumes from the last image displayed (unless you have just finished shooting).
- **[Disable]**: Playback resumes from your most recent shot whenever the camera is restarted.

Blur/Out-of-Focus Image Detection

[☑ Configuring Blur/Out-of-Focus Image Detection](#)

[☑ Playback Applying Blur/Out-of-Focus Image Detection](#)

This feature can automatically determine how blurry or out-of-focus images are, based mainly on faces in JPEG/HEIF images of people. By setting a level of blurriness or lack of focus, you can sort, protect, or rate all images at that level.

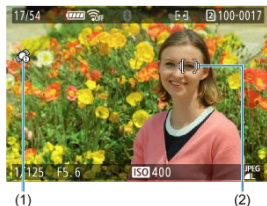

(1) : Much blurring/lack of focus, : Little blurring/lack of focus

(2) Frame indicating blur/out-of-focus detection

- When shooting, set the JPEG/HEIF image size to **L** or **M** if you will use this feature.
- You can check this image evaluation during playback on the basic information display or shooting information display screen.
- In index display, the (1) icon remains in the upper left of the playback screen regardless of the current image.

Caution

- Blur/out-of-focus detection is not performed for images captured under these conditions.
 - RAW images, or JPEG/HEIF images from RAW processing
 - Without using the electronic shutter
 - Using manual focus
 - **[AF: Subject to detect]: [None]**
 - Focus bracketing
 - Multiple exposures
 - Set to expanded ISO speed (H)
 - Using lenses compatible with the EOS VR System
 - **[📷: Dual shooting (still&movie)]** still photo shooting
- No icons or detection frames indicating the amount of blurring are shown in playback of images captured in RAW+JPEG or RAW+HEIF shooting, because RAW images are used for this playback. To check icons or detection frames indicating the amount of blurring when **[📷 Rec options]** in **[🔧: Record func +card/folder sel.]** is set to **[Rec. separately]**, select the card containing the JPEGs or HEIFs in **[📷 Play]**.
- Blur/out-of-focus detection results are not applied to images saved by using these functions.
 - Resizing
 - Cropping
 - In-camera upscaling
 - HEIF→JPEG conversion
- The following situations may prevent blur/out-of-focus detection or make the results inaccurate.
 - Faces are covered by objects such as helmets, sunglasses, or fashion accessories
 - Faces are partially hidden behind netting or water droplets
 - Subjects are not directly facing the camera
 - Faces are very small or large relative to the screen
 - Faces are at the edge of the screen
 - Faces are too dark or bright
 - Several faces are close to each other
 - A person shown is not recognized as the main subject
 - Shooting at high ISO speeds
 - Shooting people shown in photo prints or displayed on a screen
- Blur/out-of-focus detection may be applied to non-human subjects, people who are not the main subject, or body parts other than faces. This is more likely to happen after any significant changes in the main subject's posture.



Note

- In DPP, you can sort and filter images based on the camera's blur/out-of-focus detection results.

Configuring Blur/Out-of-Focus Image Detection

1. Select [▶]: Blur/Out-of-Focus image detection (🔗).
2. Set the blur/out-of-focus detection items.

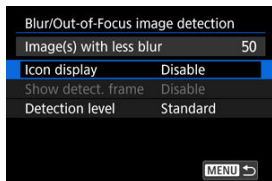

Icon display

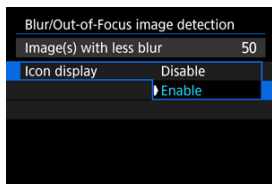

Show detect. frame

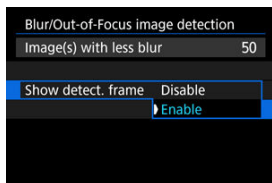

Detection level

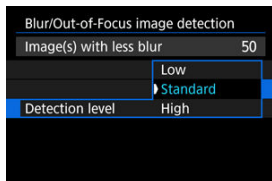

- Levels of blur/out-of-focus detection are based on these criteria.

Standard:

[👁️] (little blurring/lack of focus) is displayed for images that are fairly clear and in focus when viewed with the naked eye at actual size.

High:

[👁️] (little blurring/lack of focus) is displayed for images that are clearer and more in focus than [Standard].

Low:

[👁️] (little blurring/lack of focus) is also displayed for images that are less clear and in focus than [Standard], excluding images that are greatly blurred or out of focus.

- After completing the settings, press the <MENU> button.

⚠️ Caution

- Image evaluation by the camera may not match a subjective impression with the naked eye. This discrepancy may be greater when the level is set to [High]. Ultimately, images should be evaluated visually to decide.
- Consider changing the detection level if image evaluation by the camera does not match your impression of images.

Playback Applying Blur/Out-of-Focus Image Detection

You can configure playback so that turning the <  > dial displays images determined to be only a little blurry or out of focus.

Quick Control



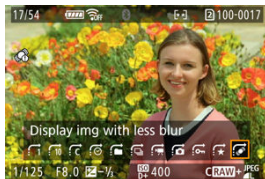

- Press the <  > button and set [Image jump w/ 

Using < > to set



- Press <  > horizontally to set to [Display img with less blur].



Note

- You can also use the <  > dial to configure image display in [: Image jump w/ 



Customizing Playback Information Display

[Histogram](#)

You can specify screens and accompanying information displayed during image playback.

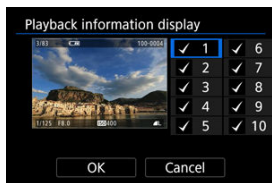
1. Select : Playback information display ().
2. Add a checkmark [✓] next to the number of screens to display.



- Select numbers with the  dial.
- Press  to clear a checkmark [✓]. Press it again to add a checkmark [✓].
- Repeat these steps to add a checkmark [✓] to the number of each screen to display, then select **[OK]**.
- Your selected information can be accessed by pressing the **<INFO>** button during playback, or by using  when shooting information is displayed.

Histogram

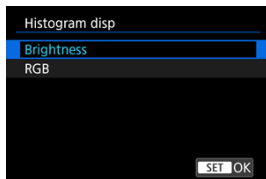

The histograms show signal levels across the tonal range. Brightness display (for checking the general exposure level and overall gradation) and RGB display (for checking saturation and gradation of red, green, and blue) are available. You can switch the histogram displayed by pressing the <INFO> button when [INFO] is displayed in the lower left of the [▶]: **Playback information display** screen.

- **[Brightness] display**

This histogram is a graph showing the distribution of the image's brightness level, with the horizontal axis indicating the brightness level (darker on the left and brighter on the right) and the vertical axis indicating the pixel count at each brightness level. The more pixels there are toward the left, the darker the image, and the more pixels there are toward the right, the brighter the image. If there are too many pixels on the left, detail in shadows will be lost, and if there are too many pixels on the right, detail in highlights will be lost. The gradation in-between will be reproduced. By checking the image and its brightness histogram, you can see the exposure level inclination and the overall gradation.

Sample histograms



Dark image



Normal brightness



Bright image

- **[RGB] display**

This histogram is a graph showing the distribution of each primary color's brightness level in the image (RGB or red, green, and blue), with the horizontal axis indicating the color's brightness level (darker on the left and brighter on the right) and the vertical axis indicating the pixel count at each color brightness level. The more pixels there are toward the left, the darker and less prominent the color, and the more pixels there are toward the right, the brighter and denser the color. If there are too many pixels on the left, the corresponding color information will be lacking, and if there are too many pixels on the right, the color will be too saturated, without gradation. By checking the image's RGB histogram, you can see the color's saturation and gradation conditions, as well as the white balance bias.

Displaying the Highlight Alert

You can specify blinking display of overexposed highlights on the playback screen. To obtain more detailed gradation in the blinking areas where you want the gradation to be faithfully reproduced, set the exposure compensation to a negative amount and shoot again for a better result.

1. Select [▶: Highlight alert] (ⓘ).
2. Select [Enable].

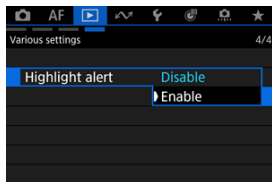

AF Point Display

You can display the AF points that were used to focus, which will be outlined in red on the playback screen.

1. Select [▶: AF point disp.] (🔒).
2. Select [Enable].

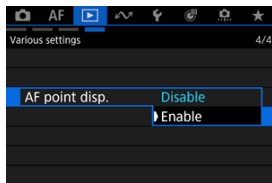

Playback Grid

You can display a grid over still photos shown in single-image display on the playback screen. This function is convenient for checking the image's vertical or horizontal tilt as well as composition.

1. Select [▶]: Playback grid (🔒).
2. Select an option.

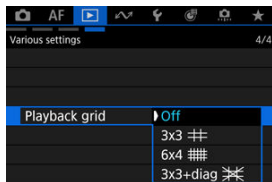

Movie Play Count

You can select how time is displayed on the movie playback screen.

1. Select [▶: Movie play count] (⊗).

2. Select an option.

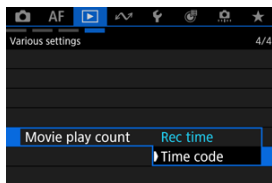

● **Rec time**

Displays the recording or playback time during movie playback.



● **Time code**

Displays the time code during movie playback.





Note

- Time codes are always recorded to movie files (except when High Frame Rate movies are set to **[Free run]**), regardless of the **[Movie rec count]** setting.
- The **[Movie play count]** setting in **[📷: Time code]** is linked to the **[▶️: Movie play count]**, so that these settings always match.
- The “frame” count is not displayed during movie recording or playback.

Communication Functions

This chapter describes how to connect the camera to a smartphone or computer, send images, and control the camera remotely.

Caution

Important

- Note that Canon cannot be held liable for any loss or damage caused by erroneous network settings when using the camera. In addition, Canon cannot be held liable for any other loss or damage caused by use of the camera.
Take security measures that you deem necessary when using a network, at your discretion. Canon cannot be held liable for any loss or damage caused by unauthorized access or other security breaches.

- [Tab Menus: Communication Functions](#)
- [Available Network Features](#)
- [Preparing to Use Communication Functions](#)
- [Network-Specific Preparation](#)
- [Transferring Images to an FTP Server](#)
- [Connecting to EOS Utility](#)
- [Uploading Images to image.canon](#)
- [Syncing Time Between Cameras](#)
- [Connecting to a Smartphone or Tablet](#)
- [Live Streaming](#)
- [Connecting to a Wireless Remote Control](#)
- [Using Camera Control API \(CCAPI\)](#)
- [GPS Device Settings](#)
- [Linked Shooting](#)
- [Basic Communication Settings](#)
- [Checking and Editing Network Settings](#)
- [Airplane Mode](#)
- [Bluetooth Settings](#)
- [Renaming the Camera](#)
- [Reference](#)
- [Error Details](#)
- [Responding to Error Messages](#)
- [Troubleshooting Guide](#)
- [Wireless Communication Precautions](#)
- [Security](#)

- [Checking Network Settings](#)
- [Wireless Communication Status](#)
- [Checking the MAC Address](#)
- [App Selection for USB Connections](#)
- [Save/Load Communication Settings on Card](#)
- [Resetting Communication Settings](#)

Tab Menus: Communication Functions

● Network settings

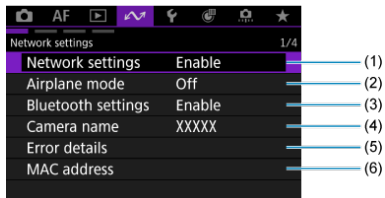

- (1) [Network settings](#)
- (2) [Airplane mode](#)
- (3) [Bluetooth settings](#)
- (4) [Camera name](#)
- (5) [Error details](#)
- (6) [MAC address](#)

● Network function

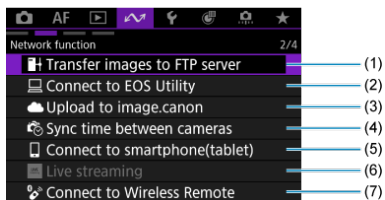

- (1) [Transfer images to FTP server](#)
- (2) [Connect to EOS Utility](#)
- (3) [Upload to image.canon](#)
- (4) [Sync time between cameras](#)
- (5) [Connect to smartphone\(tablet\)](#)
- (6) [Live streaming](#)
- (7) [Connect to Wireless Remote](#)

● Network function

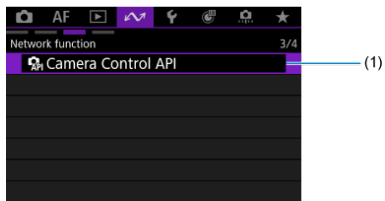

- (1) [Camera Control API](#)

● Various settings

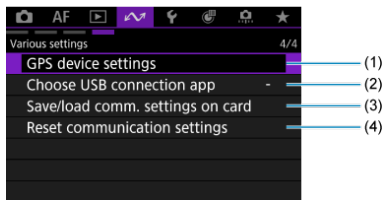

- (1) [GPS device settings](#)
(2) [Choose USB connection app](#)
(3) [Save/load comm. settings on card](#)
(4) [Reset communication settings](#)

⚠ Caution

- Some menu items cannot be configured while the camera is connected to computers or other devices via an interface cable.
- The Wi-Fi connection will be terminated if you set the camera's power to < OFF >, or open the card slot cover or battery compartment cover.
- Auto power off is not activated while connected to a network.

Available Network Features

[Features Available over a Network, and Connection Methods \(Other than Wireless Remote Control\)](#)

Transferring images to an FTP server

By connecting to an FTP server, you can send images on the camera to a computer. With FTP transfer, you can automatically transfer each image to the FTP server as you shoot or transfer a set of images together.

Connecting to EOS Utility

Using EOS Utility (EOS software), you can import images from the camera, control the camera, and perform other operations.

Uploading images to image.canon

Link the camera to image.canon to send images directly from the camera.

Syncing time between cameras

You can set the sender camera time on up to 10 receiver cameras.

Connecting to a smartphone or tablet

Using the Camera Connect app on smartphones or tablets (hereafter, collectively referred to as "smartphones"), you can browse images on the camera, shoot remotely, and perform other operations. After pairing the camera with a Bluetooth-compatible smartphone,* you only need to use the smartphone to connect via Wi-Fi.

You can also use Content Transfer Professional to transfer images from the camera to FTP servers over a mobile network connection.

* Smartphones supporting Bluetooth low energy technology.

Live streaming

You can live-stream images from the camera.

Connecting to a wireless remote control

This camera can also be connected to Wireless Remote Control BR-E1 (sold separately, ) via Bluetooth for remote control shooting.

Using Camera Control API (CCAPI)

Camera Control API is an HTTP-based application programming interface for controlling Canon cameras over a network. You can connect the camera to a smartphone (or tablet) or computer and control the camera from an application using CCAPI.

Linked shooting

Linked shooting is possible by shooting from a sender camera linked via wireless LAN to multiple receiver cameras.

Features Available over a Network, and Connection Methods (Other than Wireless Remote Control)

Available Features	Connection Method	
	Wired LAN	Wi-Fi
Transferring images to an FTP server	○	○
Connecting to EOS Utility	○	○
Uploading images to image.canon		○
Syncing time between cameras	○	○
Connecting to a smartphone or tablet		○
Live streaming		○
Camera Control API (CCAPI)	○	○
Linked shooting		○

Note

- Use of wired LAN with the camera requires Battery Grip BG-R20EP or Cooling Fan CF-R20EP (both sold separately).

Preparing to Use Communication Functions

Transferring images to an FTP server

A computer running one of the following OSes is required. The computer must also be set up in advance to function as an FTP server.

- **Windows 11**
- **Windows 10 (ver. 1607 or later)**

For instructions on setting up the computer to function as an FTP server, refer to documentation for your computer.

Connecting to EOS Utility

A computer with EOS Utility (EOS software) installed is required.

For EOS Utility installation instructions, see [Installing Computer Software](#).

Uploading images to image.canon

- A smartphone with a browser and internet connection is required.
- For instructions on how to use image.canon services and details on countries and regions where it is available, visit the image.canon site (<https://image.canon/>).
- Separate ISP connection and access point fees may apply.

Syncing time between cameras

Prepare one sender camera and up to 10 receiver cameras.

Connecting to a smartphone or tablet

Install the app on an Android smartphone or an iPhone (📱).

The app can be installed from Google Play or App Store.

Live streaming

Check the streaming requirements and terms of service in advance on the streaming site.

Linked shooting

The following cameras or combinations of cameras and accessories can be used in linked shooting.

- EOS R1
- EOS R5 Mark II
- EOS-1D X Mark III with Wireless File Transmitter WFT-E9B connected
- EOS R5 with Wireless File Transmitter WFT-R10B connected

Network-Specific Preparation

 [Wired LAN Connections](#)

 [Wi-Fi Connections](#)

Wired LAN Connections

- Use of wired LAN with the camera requires Battery Grip BG-R20EP or Cooling Fan CF-R20EP (both sold separately).
- Connect a LAN cable to the Ethernet RJ-45 terminals of the battery grip and the computer or access point.

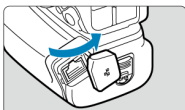

Battery Grip BG-R20EP

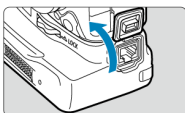

Cooling Fan CF-R20EP

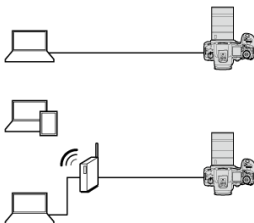

 **Caution**

- Use a highly shielded Category 6A or higher STP (Shielded Twisted Pair) Gigabit LAN cable.

Wi-Fi Connections

When using the camera in infrastructure mode, make sure the smartphone or computer you will use can connect to the access point.

Caution

Transferring movies

- Each movie file is large, and transferring large files over Wi-Fi may take some time. Referring to [Wireless Communication Precautions](#), arrange your network environment for stable communication between devices and the access point.

Transferring Images to an FTP Server

- [✔ Configuring FTP Server Connection Settings](#)
- [✔ Editing/Deleting Devices for Connections](#)
- [✔ Reconnecting Using Connection Information](#)
- [✔ Transferring Images Individually](#)
- [✔ Transferring Multiple Images at Once](#)
- [✔ Using the \[Image sel./transfer\] Screen](#)
- [✔ Adding a Caption Before Transfer](#)
- [✔ Auto Retry If Transfer Fails](#)
- [✔ Using the Power Saving Function](#)
- [✔ Protecting Images after Transfer](#)
- [✔ Viewing Transferred Images](#)
- [✔ Transferring Image with Content Transfer Professional](#)

By connecting to an FTP server, you can send images on the camera to a computer. With FTP transfer, you can automatically transfer each image to the FTP server as you shoot or transfer a set of images together.

Configuring FTP Server Connection Settings

For secure FTP transfer using a root certificate, import a root certificate (🔗).

1. Select [🔗]: **Transfer images to FTP server** (🔗).
2. Select [OK].

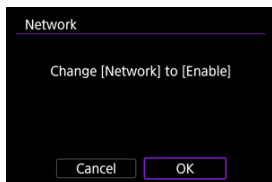

- This screen is not displayed if the network setting is already set to **[Enable]**.

3. Select [**Add a device to connect to**].

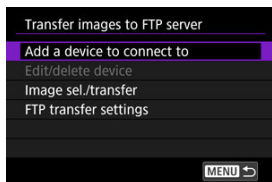

4. Select an option.

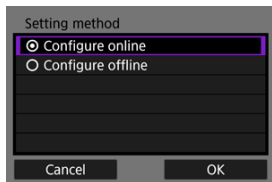

- Select [**OK**] to go to the next screen.
- Selecting [**Configure offline**] will keep the camera disconnected from the network after configuration.

5. Select [**New settings**].

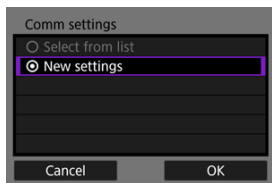

- Select [**OK**] to go to the next screen.
- By selecting [**Select from list**] when settings are already registered on the camera, you can apply the registered settings.

6. Select an option.

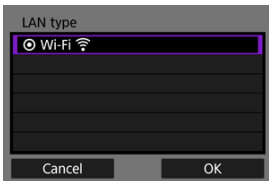

- Select **[OK]** to go to the next screen.
- For instructions on configuring communication functions, see [Basic Communication Settings](#).

7. Save the settings.

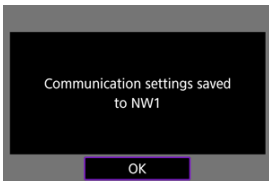

- Press **<SET>**.
- After you finish the communication settings, configure FTP transfer.

8. Select an option.

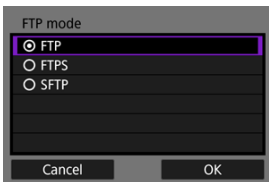

- For secure FTP transfer using a root certificate, select **[FTPS]**.
- For secure FTP transfer over an SSH connection, select **[SFTP]**.
- Select **[OK]** to go to the next screen.

9. Configure the FTP server settings.

FTP server

Address setting

Port number setting 00022

Address
192.168.1.20

Cancel OK

- Select [**Address setting**] or [**Port number setting**], then press < (SET) > to display the setting screen.
- Select [**OK**] to go to the next screen.

10. Configure the SSH login authentication settings.

SSH login settings

User name XXXXX

Password *****

Cancel OK

- Displayed if you selected [**SFTP**] as the FTP mode.
- Select [**User name**] or [**Password**], then press < (SET) > to display the setting screen.
- Select [**OK**] to go to the next screen.

11. Select an option.

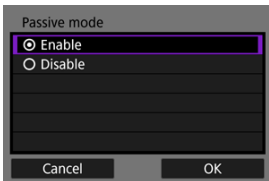

- Displayed if you selected **[FTP]** or **[FTPS]** as the FTP mode.
- Enable this setting in network environments protected by a firewall.
- Select **[OK]** to go to the next screen.
- If an Error 41 (Cannot connect to FTP server) is displayed while you are configuring the connection, setting **[Passive mode]** to **[Enable]** may resolve it.

12. Configure proxy server settings.

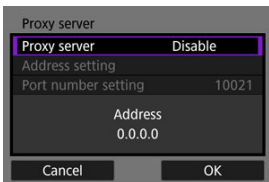

- Displayed if you selected **[FTP]** as the FTP mode.
- Select **[OK]** to go to the next screen.

13. Select an option.

Login method

Anonymous

Login password

Login name
anonymous

Cancel OK

- Displayed if you selected **[FTP]** or **[FTPS]** as the FTP mode.
- Select **[OK]** to go to the next screen.

Note

- If you have selected **[Login password]**, enter the name and password.

Login name

Enter the FTP server login name
(up to 32 characters)

anonymous

Cancel OK

Password

Enter the FTP server password
(up to 32 characters)

Cancel OK

14. Specify a target folder.

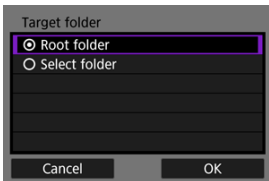

- Select [**Root folder**] to have images saved in the root folder, as specified in FTP server settings (🔗).
- Select [**Select folder**] to access the setting screen.
- Select [**OK**] to go to the next screen.



Note

- When the following message appears, select [**OK**] to trust the target server.

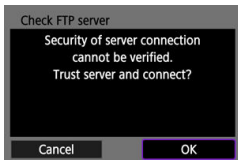

- If you have selected [**Select folder**], enter the name of the destination folder.

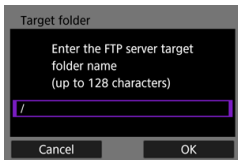

15. Press < **SET** >.

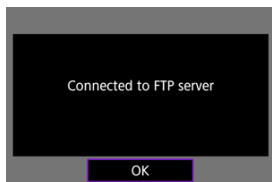

- The FTP settings are saved.
- This screen is not displayed if you selected [**Configure offline**] as the method of configuration.

Connection settings for FTP transfer are now complete.

 **Note**

- When images to transfer are selected, the following screen is displayed. Select [**OK**] to transfer the images ().



[+Communicating] screen

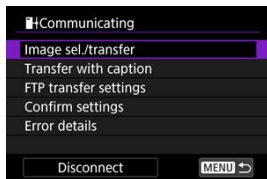

- **Image sel./transfer**
Images can be transferred to an FTP server (🔗).
- **Transfer with caption**
You can add a registered caption to individual images before transfer (🔗).
- **FTP transfer settings**
You can configure settings related to FTP transfer and power saving.
 - [Automatic transfer](#)
 - [Images to transfer](#)
 - [Transfer with SET](#)
 - [Set root certif](#)
 - [Power saving](#)
 - [Protect images](#)
- **Confirm settings**
You can check setting details.
- **Error details**
After any network connection errors, you can check the error details (🔗).
- **Disconnect**
Terminates the network connection.

Importing a root certificate for FTPS

If you specified [FTPS] FTP mode when configuring connection settings, the root certificate used by the FTP server must be imported to the camera.

- Only the root certificate with a file name of "ROOT.CER," "ROOT.CRT," or "ROOT.PEM" can be imported to the camera.
- Only one root certificate file can be imported to the camera. Insert a card containing the root certificate file in advance.
- The priority card selected for [📷 Record/play], [📺 Record/play], [📷 Play], or [📺 Play] in [🔧: Record func+card/folder sel.] is used to import a certificate.
- It may not be possible to trust servers you try to connect to in FTPS connections with a self-signed certificate.

1. Select [🔧: 📷 Transfer images to FTP server] (🔗).
2. Select [OK].

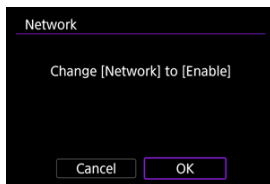

- This screen is not displayed if the network setting is already set to [Enable].

3. Select [FTP transfer settings].

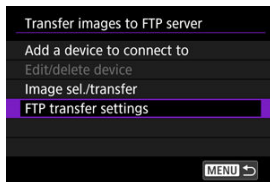

4. Select [Set root certif].

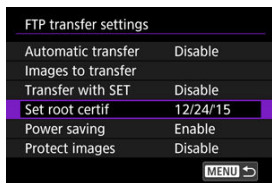

5. Select [Load root certif from card].

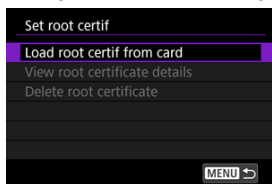

6. Select [OK].



- The root certificate is imported.
- Select [OK] on the confirmation screen to return to the [Set root certif] screen.

 Note

- To delete the root certificate imported to the camera, select [Delete root certificate] on the screen in step 5. To check who it was issued to and issued by, the period of validity, and other information, select [View root certificate details].

Editing/Deleting Devices for Connections

Before editing or deleting connection settings for other devices, end the Wi-Fi connection. This section covers items not described in [Configuring FTP Server Connection Settings](#).

1. Select []: **Transfer images to FTP server** ().

2. Select [**Edit/delete device**].

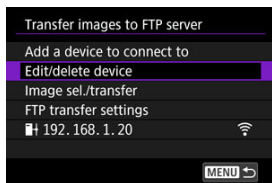

3. Select the device.

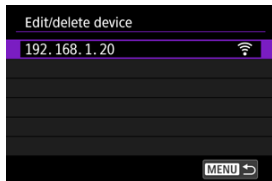

- Select the device for the connection, then press < >.

4. Select an option.

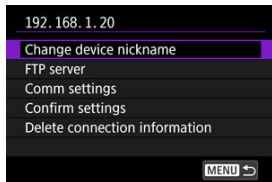

Changing device nicknames

You can change the nickname of devices the camera connects to.

FTP server

You can configure FTP server settings.

Directory structure

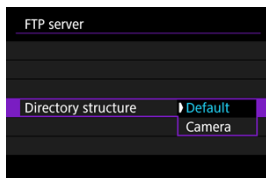

- **Default**

The server root folder is used for image storage. If you have created a subfolder in the root folder by changing the **[Target folder]** setting, images are saved in that folder.

- **Camera**

Automatically creates a folder structure matching that of the camera's (such as A/DCIM/100EOSR1) in the server's root folder for image storage. If you have created a subfolder in the root folder by changing the **[Target folder]** setting, a folder structure such as A/DCIM/100EOSR1 is automatically created in that folder for image storage.

Overwrite same file

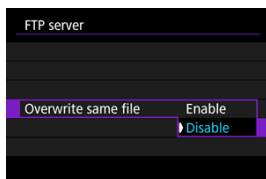

- **Disable**

If there is already a file with the same name in the target folder on the FTP server, the new file is saved with an extension consisting of an underscore and a number, as in IMG_0003_1.JPG.

- **Enable**

Any files with the same name in the target folder on the FTP server are overwritten by transferred images.

Note

- Even if **[Enable]** is selected when you resend images that could not be transferred initially, existing images may not be overwritten in some cases. If this happens, the new file is saved with an extension consisting of an underscore, a letter, and a numeral, as in IMG_0003_a1.JPG.

Trusting target servers

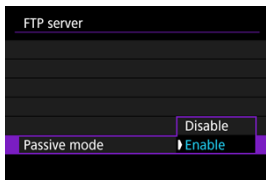

Set to **[Enable]** if you prefer to connect to FTP servers even when trust cannot be established based on the root certificate used. In this case, take suitable security measures.

Communication settings

You can change communication settings as needed ([🔗](#)).

Deleting connection information

You can delete the connection information.

Reconnecting Using Connection Information

The configured connection information can be used to connect again.

1. Select [MENU]: **Transfer images to FTP server** (☑).
2. Select the device.

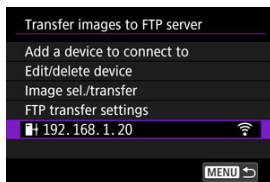

3. Select [OK].

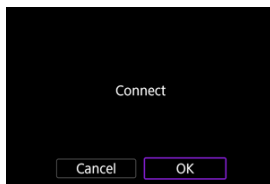



Transferring Images Individually

- [Automatic transfer after each shot](#)
- [Specifying sizes or types of images to transfer](#)
- [Transferring the current image](#)

Automatic transfer after each shot

Each image can be immediately transferred to the FTP server automatically after your shot. You can continue shooting still photos as usual while images are being transferred.

- Before shooting, make sure a card is in the camera. If you shoot without recording images, they cannot be transferred.
- Automatic transfer of movies during recording is not supported. After recording, transfer movies as described in [Transferring Multiple Images at Once](#) or [Adding a Caption Before Transfer](#).

1. Select [ Transfer images to FTP server] ()
2. Select [FTP transfer settings].

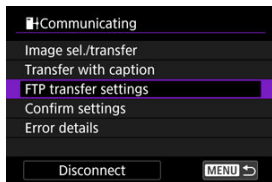

3. Select [Automatic transfer].

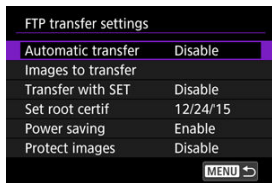

4. Select [Enable].

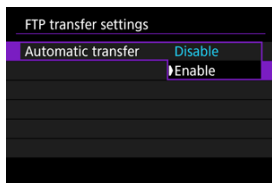

5. Take the picture.

- The captured image is transferred to the FTP server.

⚠ Caution

- Images cannot be erased during image transfer.

📄 Note

- Captured images are also stored on the card.
- Any images for which transfer fails or is interrupted will be transferred automatically when the connection is recovered (🔄). These images can also be transferred together manually at a later time (🔄).
- Repeated automatic transfer is not attempted if network settings (such as FTP server settings) are changed before automatic FTP transfer begins.

Specifying sizes or types of images to transfer

You can specify which images to transfer when recording images of different sizes to both cards, or when shooting RAW+JPEG or RAW+HEIF images.

1. Access the [FTP transfer settings] screen.

- Follow steps 1–2 in [Automatic transfer after each shot](#).

2. Select [Images to transfer].

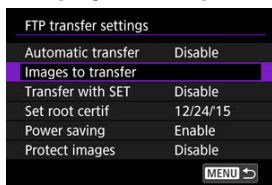

3. Select the size of images to transfer.

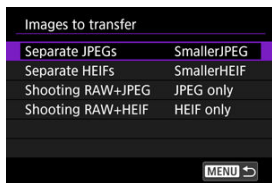

- **Separate JPEGs**
Choose [SmallerJPEG] or [Larger JPEG].
- **Separate HEIFs**
Choose [SmallerHEIF] or [Larger HEIF].

4. Select the type of images to transfer.

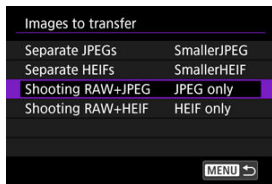

- **Shooting RAW+JPEG**
Choose from [JPEG only], [RAW only] or [RAW+JPEG].
- **Shooting RAW+HEIF**
Choose from [HEIF only], [RAW only] or [RAW+HEIF].

Note

- [Separate JPEGs] or [Separate HEIFs] determines the image size transferred if [Rec options] in [Record func+card/folder sel.] is selected with different image quality set for each card (🔗).
- When the camera is set to record RAW images to one card and JPEGs or HEIFs to the other, specify which images to transfer in the [Shooting RAW+JPEG] or [Shooting RAW+HEIF] setting. Similarly, specify your transfer preference when RAW+JPEG images or RAW+HEIF images are simultaneously recorded to a single card.
- Captured images are also stored on the card.
- When images of the same size are recorded to both cards simultaneously, images recorded to the card selected for [Record/play] or [Play] in [Record func+card/folder sel.] are given priority for transfer.

Transferring the current image

Enables you to transfer the image you are viewing simply by pressing < **SET** >. You can continue shooting still photos as usual while images are being transferred.

1. Access the [FTP transfer settings] screen.

- Follow steps 1–2 in [Automatic transfer after each shot](#).

2. Select [Transfer with SET].

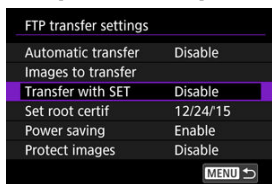

3. Select [Enable].

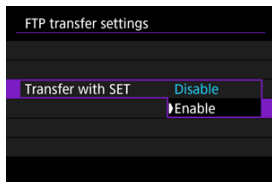

4. Select an image.

- On the camera, press the < **▶** > button.
- Select an image to transfer, then press < **SET** > to transfer the image.
- Movies cannot be transferred this way. Selecting a movie and pressing < **SET** > will display the movie playback panel.

Transferring Multiple Images at Once

After shooting, you can select multiple images and transfer them all at once, or you can transfer unsent images or images that could not be sent previously. You can continue shooting still photos as usual during transfer.

Caution

- Transfer is paused in the following cases.
 - Movie recording in progress
 - Pre-recording in progress
 - [📷: Standby: Low res.] is set to [Off]
- If you will transfer many images, consider using a household power outlet accessory (sold separately).

1. Select [📷: 📡 Transfer images to FTP server] (🔗).
2. Select [Image sel./transfer].

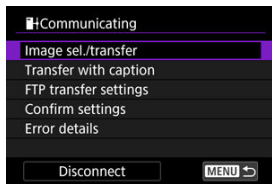

- The [📷: 📡 Image sel./transfer] screen is displayed.
- For details on the [📷: 📡 Image sel./transfer] screen, see [Using the \[📷: 📡 Image sel./transfer\] Screen](#).

Using the [Image sel./transfer] Screen

- [Selecting \(\[√\]\) multiple images to transfer](#)
- [Specifying a range of images to transfer](#)
- [Transferring all images in a folder](#)
- [Transferring all images on a card](#)

From the [Image sel./transfer] screen, you can select multiple images and transfer them all at once.

Selecting ([√]) multiple images to transfer





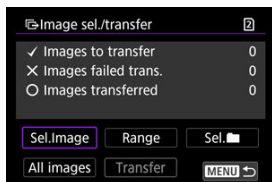

By adding checkmarks to your selected images, you can transfer all of them at once.

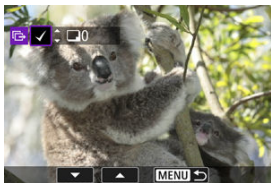
1. Select [Sel.Image].



2. Select the image to transfer.



- Use the  dial to select an image to transfer, then press  >.
- Use the  dial to add a checkmark [✓] in the upper left of the screen, then press  >.
- For three-image display, turn the  dial counterclockwise. To return to single-image display, turn the  dial clockwise.
- To select other images to transfer, repeat step 2.
- After image selection, press the < MENU > button.

3. Select [Transfer].



4. Select [OK].



- The selected images are transferred to the FTP server.

Specifying a range of images to transfer

You can transfer multiple images by specifying a range.

1. Select [Range].



2. Specify the range of images.



- Select the first image (start point).
- Next, select the last image (end point). A checkmark [✓] will be appended to all the images within the range between first and last images.
- To select other images, repeat step 2.
- After image selection, press the <MENU> button.

3. Select [Transfer].

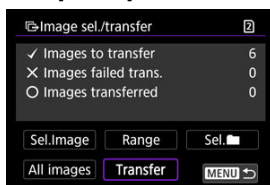

4. Select [OK].



- The selected images are transferred to the FTP server.

Transferring all images in a folder

You can transfer all the images in a folder at once.

1. Select [Sel. ].

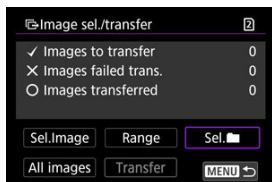

2. Select a selection method.

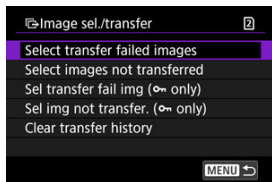

- **Select transfer failed images**
Selects all images in the selected folder for which transfer failed.
- **Select images not transferred**
Selects all unsent images in the selected folder.
- **Sel transfer fail img (🔒 only)**
Selects all protected images in the selected folder for which transfer failed.
- **Sel img not transfer. (🔒 only)**
Selects all unsent protected images in the selected folder.
- **Clear transfer history**
Clears the transfer history of images in the selected folder.



Note

- After clearing the transfer history, you can select [**Select images not transferred**] and transfer all images in the folder again.
- After clearing the transfer history, you can select [**Sel img not transfer. (🔒 only)**] and transfer all protected images in the folder again.

3. Select the folder.

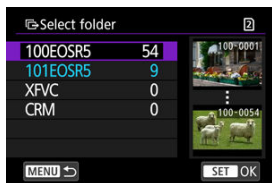

4. Select [OK].



- Selected images are registered in [Images to transfer].

5. Select [Transfer].



6. Select [OK].



- The selected images are transferred to the FTP server.

Transferring all images on a card

You can transfer all the images on a card at once.

1. Select [All images].



2. Select a selection method.

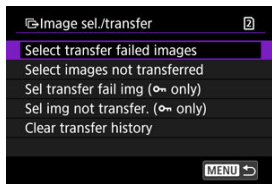

- **Select transfer failed images**
Selects all images on the card for which transfer failed.
- **Select images not transferred**
Selects all unsent images on the card.
- **Sel transfer fail img (o-n only)**
Selects all protected images on the card for which transfer failed.
- **Sel img not transfer. (o-n only)**
Selects all unsent protected images on the card.
- **Clear transfer history**
Clears the transfer history of images on the card.



Note

- After clearing the transfer history, you can select [**Select images not transferred**] and transfer all images recorded on the card again.
- After clearing the transfer history, you can select [**Sel img not transfer. (o-n only)**] and transfer all protected images recorded on the card again.

3. Select [OK].



- Selected images are registered in [Images to transfer].

4. Select [Transfer].



5. Select [OK].



- The selected images are transferred to the FTP server.

Adding a Caption Before Transfer

You can add a registered caption to each image before transfer. This is convenient if you want to inform the recipient of the printing quantity, for example. Captions are also added to images saved to the camera.

- You can check captions added to images by examining the Exif information, in the user comments.
- Captions can be created and registered with EOS Utility (🔗).

1. Select [🔗: 📡Transfer images to FTP server] (🔗).
2. Select [Transfer with caption].

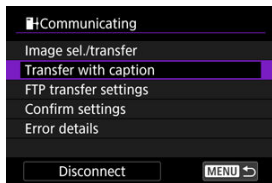

- The last image viewed is displayed.

3. Specify the caption.

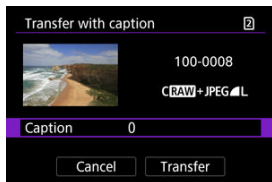

- Select [**Caption**], and on the screen displayed, select the content of the caption.



4. Select [Transfer].

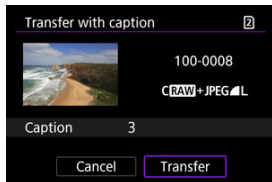



- The image is transferred with the caption. After transfer, display returns to the [**Image transfer**] screen.

⚠ Caution

- Other images cannot be selected from the [**Transfer with caption**] screen. To select another image for transfer with a caption, view that image before following these steps.

Auto Retry If Transfer Fails

If transfer fails, the Wi-Fi icon blinks temporarily. In this case, the following screen is displayed after you press the < MENU > button and select [:  Transfer images to FTP server].

To resolve the error displayed, see [Responding to Error Messages](#).





Once you have resolved the issue, the images that could not be sent initially will be transferred automatically. With this option activated, transfer is attempted again automatically after failure, whether automatic transfer is used or captured images are transferred via FTP. Note that if you cancel transfer or turn the camera off, auto retry is not attempted.

See [Transferring Multiple Images at Once](#) and transfer images as needed.

Using the Power Saving Function

When **[Enable]** is set and no image is transferred for a certain period, the camera will log off from the FTP server and end the Wi-Fi connection. The connection is re-established automatically when the camera is ready for image transfer again. If you prefer not to end the Wi-Fi connection, set to **[Disable]**.

1. Select []: **[Transfer images to FTP server]** ().
2. Select **[FTP transfer settings]**.

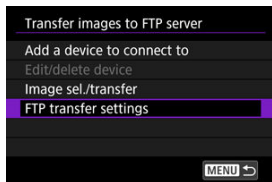

3. Select **[Power saving]**.

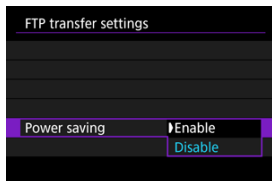

Protecting Images after Transfer

To automatically protect images transferred via FTP, set to [Enable] (🔒).

1. Select [MENU] → Transfer images to FTP server (🔒).
2. Select [FTP transfer settings].

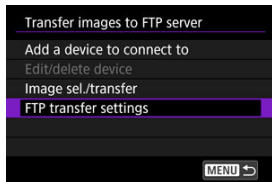

3. Select [Protect images].

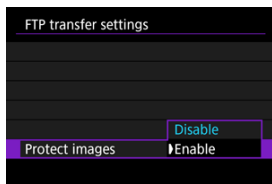

Viewing Transferred Images

Images transferred to the FTP server are stored in the following folder as specified in the FTP server settings.

Target folder of the FTP server

- Under the default settings of the FTP server, images are stored in [C drive] → [Inetpub] folder → [ftproot] folder, or in a subfolder of this folder.
- If the root folder of the transfer destination has been changed in the FTP server settings, ask the FTP server administrator where images are transferred.

Transferring Image with Content Transfer Professional

Using the Content Transfer Professional smartphone app, you can transfer images from the camera to FTP servers over a mobile network connection.

For information about the app, see [Software/Apps](#).

Connecting to EOS Utility

- [Operating the Camera Using EOS Utility](#)
- [Editing/Deleting Devices for Connections](#)
- [Reconnecting Using Connection Information](#)
- [Transferring Multiple Images at Once \(Direct Transfer\)](#)
- [Transferring RAW+JPEG or RAW+HEIF Images](#)
- [Creating and Registering Captions](#)

This section describes how to connect the camera to a computer and perform camera operations using EOS software or other dedicated software. Install the latest version of software on the computer before setting up a connection.

For computer operating instructions, refer to the computer user manual.

Operating the Camera Using EOS Utility

Using EOS Utility (EOS software), you can import images from the camera, control the camera, and perform other operations.

Steps on the camera (1)

1. Select [ Connect to EOS Utility] ().
2. Select [OK].

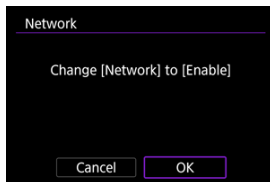

- This screen is not displayed if the network setting is already set to **[Enable]**.

3. Select [Add a device to connect to].

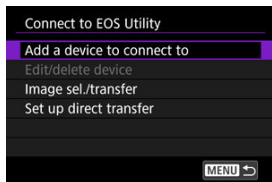

4. Select [New settings].

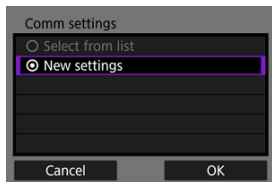

- Select [OK] to go to the next screen.
- By selecting [Select from list] when settings are already registered on the camera, you can apply the registered settings.

5. Select an option.

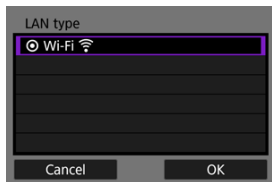

- Select [OK] to go to the next screen.
- For instructions on configuring communication functions, see [Basic Communication Settings](#).

6. Save the settings.

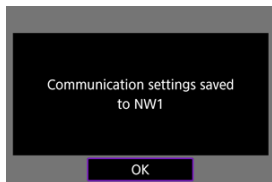

- Press < **SET** >.
- The next screen is displayed after communication settings are complete.

7. Select [OK].

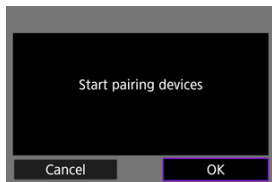

- The following message is displayed. "*****" represents the last six digits of the MAC address of the camera to be connected.

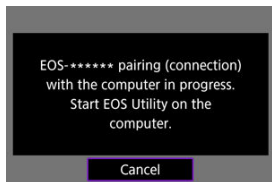

8. Start EOS Utility.

- Connect the computer to the network and start EOS Utility.

9. In EOS Utility, click [Pairing over Wi-Fi/LAN].

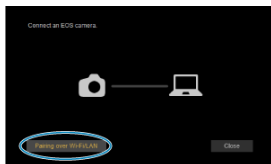

- If a firewall-related message is displayed, select [Yes].

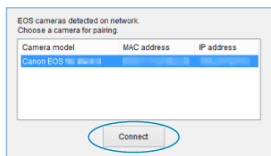

10. Click [Connect].

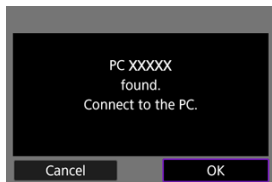

- Select the camera to connect to, then click [Connect].

11. Establish a connection.



- Select **[OK]** to go to the next screen.
- The [ **Communicating**] screen is displayed on the camera ().

The camera and computer are now connected.

[Communicating] screen

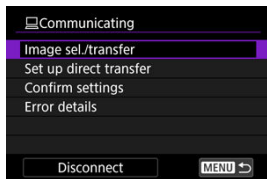

- **Image sel./transfer**
You can use the camera to transfer images to a computer (🔗).
- **Set up direct transfer**
You can specify the format of images to transfer to a computer (🔗).
- **Confirm settings**
You can check setting details.
- **Error details**
You can check the details of any errors that occur (🔗).
- **Disconnect**
Terminates the connection.

⚠ Caution

- The following will occur if you terminate the connection during remote movie recording.
 - Any movie recording in progress in movie recording mode will continue.
 - Any movie recording in progress in still photo shooting mode will end.
- You cannot use the camera to shoot in still photo shooting mode when it is set to movie recording mode in EOS Utility.
- With a connection established to EOS Utility, certain functions are unavailable.
- In remote shooting, the AF speed may become slower.
- Depending on the communication status, image display or shutter release timing may be delayed.
- In Remote Live View shooting, the rate of image transmission is slower compared to a connection via an interface cable. Therefore, moving subjects cannot be displayed smoothly.

Editing/Deleting Devices for Connections

Before editing or deleting connection settings for other devices, end the connection. This section covers items not described in [Operating the Camera Using EOS Utility](#).

1. Select [ Connect to EOS Utility] ().

2. Select [Edit/delete device].

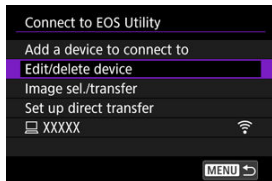

3. Select the device.

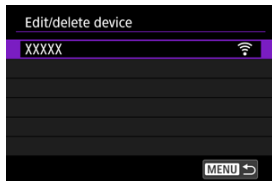

- Select the device for the connection, then press < >.

4. Select an option.

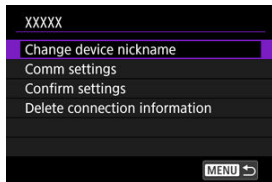

Changing device nicknames

You can change the nickname of devices the camera connects to.

Communication settings

You can change communication settings as needed ()

Deleting connection information

You can delete the connection information.

Reconnecting Using Connection Information

The configured connection information can be used to connect again.

1. Select [**☰**]: **Connect to EOS Utility** (**🔗**).
2. Select the device.

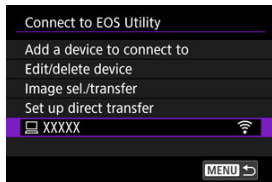

3. Select [**OK**].

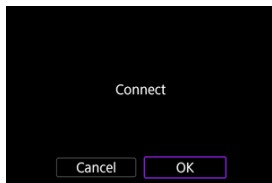

Transferring Multiple Images at Once (Direct Transfer)

With the camera connected to a computer (via Wi-Fi or an interface cable) and the main EOS Utility window displayed, you can use the camera to transfer images to a computer.

Caution

- If you will transfer many images, consider using a household power outlet accessory (sold separately).

Access the [Image sel./transfer] screen.

1. Select [Connect to EOS Utility] ().
2. Select [Image sel./transfer].

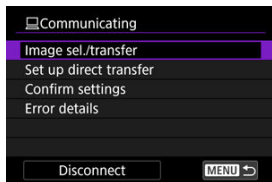

- The [Image sel./transfer] screen is displayed.

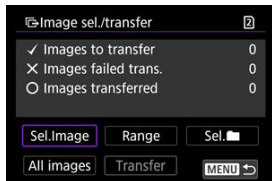

- For details on the [Image sel./transfer] screen, see [Using the \[Image sel./transfer\] Screen](#).

Transferring RAW+JPEG or RAW+HEIF Images

For RAW+JPEG or RAW+HEIF images, you can specify which image to transfer.

1. Select [**☑**: **Connect to EOS Utility**] (**☑**).
2. Select [**Set up direct transfer**].

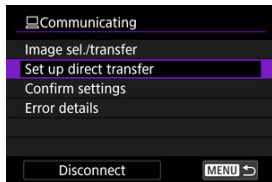

3. Select the type of images to transfer.

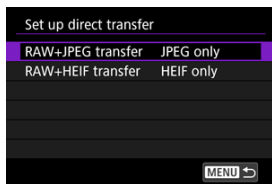

- **RAW+JPEG transfer**
Choose from [**JPEG only**], [**RAW only**] or [**RAW+JPEG**].
- **RAW+HEIF transfer**
Choose from [**HEIF only**], [**RAW only**] or [**RAW+HEIF**].

! Caution

- Some menu items are not available during image transfer.

Creating and Registering Captions

You can create captions and register them on the camera to use them as described in [Adding a Caption Before Transfer](#).

1. Start EOS Utility and select [Camera settings].

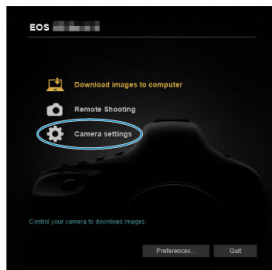

2. Select [WFT Captions].

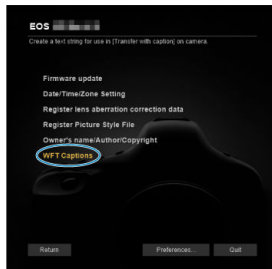

3. Enter the captions.

Register text to use with
[Transfer with caption] feature.

1	Canon
2	1
3	2
4	3

- Enter up to 31 characters (in ASCII format).
- To acquire caption data stored on the camera, select [**Load settings**].

4. Set the captions on the camera.

13	12
14	13
15	14

- Select [**Apply to camera**] to set your new captions on the camera.

Uploading Images to image.canon

 [Connecting the Camera to image.canon](#)

 [Uploading Images to image.canon](#)

This section describes how to send images to image.canon.

Connecting the Camera to image.canon

Link the camera to image.canon to send images directly from the camera.

- A smartphone with a browser and internet connection is required.
- For instructions on how to use image.canon services and details on countries and regions where it is available, visit the image.canon site (<https://image.canon/>).
- Separate ISP connection and access point fees may apply.

1. Select [ Upload to image.canon] ().
2. Select [OK].

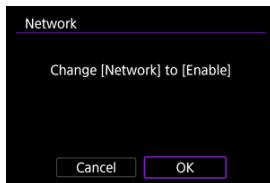

- This screen is not displayed if the network setting is already set to [Enable].

3. Select [Connect].

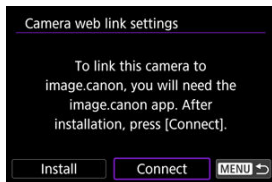

- If the app has not been installed, select [Install].

4. Select [OK].

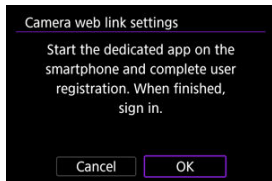

5. Use the app to scan the QR code.



- Select [OK] to go to the next screen.

6. Select [New settings].

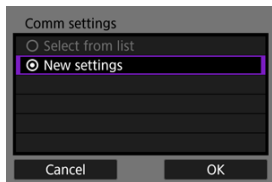

- Select [**OK**] to go to the next screen.
- By selecting [**Select from list**] when settings are already registered on the camera, you can apply the registered settings.

7. Select [OK].

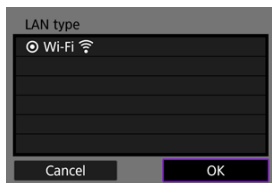

- For instructions on configuring communication functions, see [Basic Communication Settings](#).

8. Check the number shown in the app.

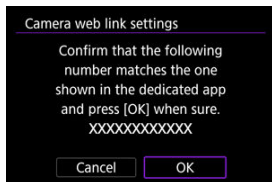

- Select [**OK**].

9. Complete the settings.

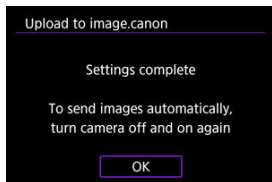

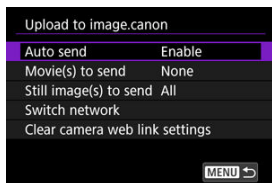

- Press <  >.



- The setting menu is displayed on the camera screen.

Note

- The [] icon changes to [].

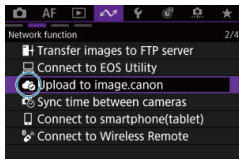

10. Check the app.

- Confirm that the camera model name is registered in the app.

[Upload to image.canon] screen

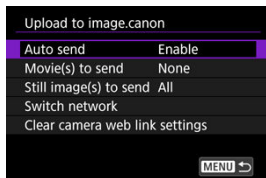

- **Auto send** (🔗)
You can choose whether to upload images automatically.
- **Movie(s) to send**
You can select the type of movies uploaded.
- **Still image(s) to send**
You can select the type of still photos uploaded.
- **Switch network**
You can change the settings for network connections.
- **Clear camera web link settings**
You can clear the camera web link settings.

Uploading Images to image.canon

Images are automatically uploaded to image.canon after the camera starts up (or recovers from auto power off). Images uploaded to image.canon can be downloaded to a computer or transferred to other web services.

- Uploading is not possible during interval timer shooting.

1. Select [**☑**]: **☑**Upload to image.canon] (**☑**).

2. Set [Auto send] to [Enable].

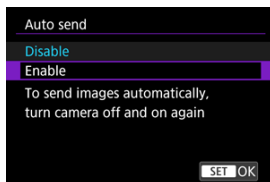

3. Configure [Still image(s) to send].

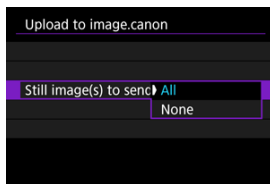

- **All**
All still photos will be uploaded.
- **None**
No still photos will be uploaded.

4. Configure [Movie(s) to send].

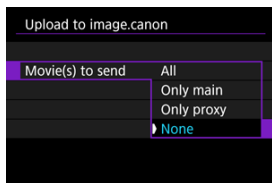

- **All**
All movies will be uploaded.
- **Only main**
Only main movies (🔒) will be uploaded.
- **Only proxy**
Only proxy movies (🔒) will be uploaded.
- **None**
No movies will be uploaded.

5. Restart the camera.



Note

- Uploaded still photos and movies are stored at image.canon for 30 days at the original size, without storage limitations.

Syncing Time Between Cameras

 [Preparing for Time Syncing](#)

 [Syncing the Time](#)

You can set the sender camera time on up to 10 receiver cameras. Note that even after synchronization, a slight margin of error applies between sender and receiver camera time (of ± 0.05 seconds, at most).

Caution

- Not available for different camera models over a Wi-Fi connection. When using a wired LAN connection, an EOS R5 with Wireless File Transmitter WFT-R10B connected can also be used.
- This feature will not be available after 2038.

Note

- Use of wired LAN with the camera requires Battery Grip BG-R20EP or Cooling Fan CF-R20EP (both sold separately).

Preparing for Time Syncing

Wired LAN connections

- **With only one receiver camera**

Connect a LAN cable to the Ethernet RJ-45 terminal of the sender and receiver cameras.

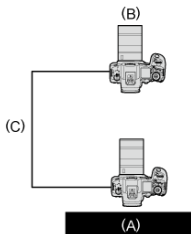

- (A) Sender camera
- (B) Receiver camera
- (C) LAN cable

- **With multiple receiver cameras**

Connect a LAN cable from the Ethernet terminal of the sender and receiver cameras to a hub. Up to 10 receiver cameras can be connected.

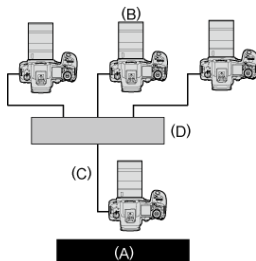

- (A) Sender camera
- (B) Receiver camera
- (C) LAN cable
- (D) Hub



 **Caution**

- Use a highly shielded Category 6A or higher STP (Shielded Twisted Pair) Gigabit LAN cable.

Syncing the Time

Preparing the sender camera

First, set up the camera to use as a sender.

1. Select [✔️]:  Sync time between cameras] (.

2. Select [OK].

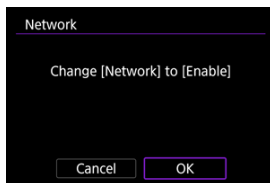

- This screen is not displayed if the network setting is already set to [Enable].

3. Select [OK].

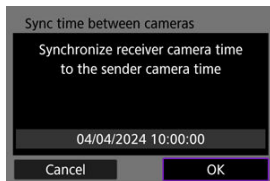

4. Select an option.

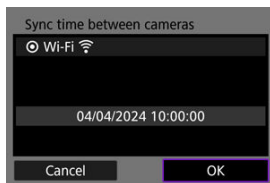

- Select **[OK]**.

5. Select **[Sender]**.

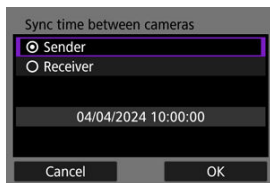

- Select **[OK]** to go to the next screen.
- After the screen is displayed, the camera is ready.

Preparing receiver cameras

Set up cameras to use as receivers.

1. Follow steps 1–4 in [Preparing the sender camera](#).
2. Select [Receiver].

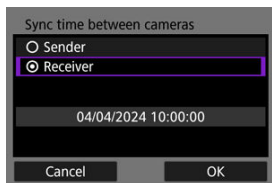

- Select [OK] to go to the next screen.

3. Select [OK].

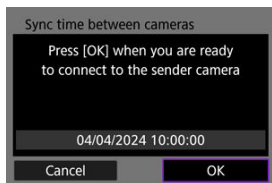

- The following screen is displayed.

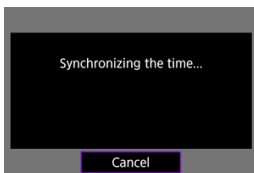

- To set the time on multiple receiver cameras, follow steps 1–3 on each receiver camera.
- The number of receiver cameras detected is displayed on the sender camera screen.

Syncing time between sender and receiver cameras

Sync the time on the sender and receiver cameras as follows.

1. Follow steps 1–5 in [Preparing the sender camera](#) and steps 1–3 in [Preparing receiver cameras](#).
2. Start time synchronization on the sender camera.

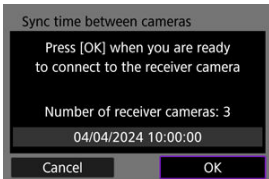

- Check the number of receiver cameras that are connected, then select [OK].
- After the time is synchronized, the next screen is displayed.

3. Press <  > on all of the cameras.

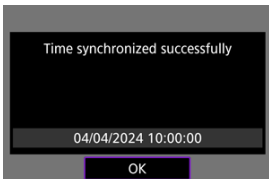

Connecting to a Smartphone or Tablet

- [☑ Turning on Bluetooth and Wi-Fi on a Smartphone](#)
- [☑ Installing the App on a Smartphone](#)
- [☑ Bluetooth Pairing and Wi-Fi Connection to Smartphones](#)
- [☑ Main Functions of Camera Connect](#)
- [☑ Maintaining a Wi-Fi Connection When the Camera Is Off](#)
- [☑ Connecting to Smartphones without Bluetooth Pairing](#)
- [☑ Editing/Deleting Devices for Connections](#)
- [☑ Reconnecting Using Connection Information](#)
- [☑ Automatic Image Transfer to a Smartphone as You Shoot](#)
- [☑ Sending Images to a Smartphone from the Camera](#)

You can do the following after the camera and smartphone are paired via Bluetooth.

- Establish a Wi-Fi connection using only the smartphone (☑).
- Establish a Wi-Fi connection with the camera even when it is off (☑).
- Control the camera remotely from a smartphone (☑).

You can also do the following after connecting the camera to a smartphone via Wi-Fi.

- Browse and save images on the camera from a smartphone (☑).
 - Control the camera remotely from a smartphone (☑).
 - Send images to a smartphone from the camera (☑).
-

Turning on Bluetooth and Wi-Fi on a Smartphone

Turn on Bluetooth and Wi-Fi from the smartphone settings screen. Note that pairing with the camera is not possible from the smartphone's Bluetooth settings screen.

Installing the App on a Smartphone

Install the app on an Android smartphone or an iPhone.

- Use the latest version of the smartphone OS.
- The app can be installed from Google Play or App Store. Google Play or App Store can also be accessed using the QR codes that appear when the camera is paired or connected via Wi-Fi to a smartphone.



Note

- Check the app download site for the required OS version.
- Sample screens and other details in this manual may not match the actual user interface elements after camera firmware, app, Android, or iOS updates.

1. Select [√]: [Connect to smartphone(tablet)] (Ⓜ).
2. Select [OK].

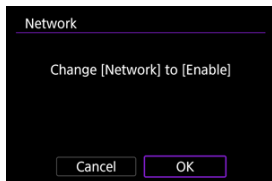

- This screen is not displayed if the network setting is already set to [Enable].

3. Select [Camera Connect].

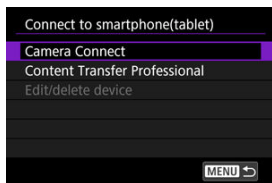

4. Select [Add a device to connect to].

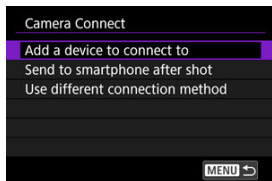

5. Select [OK].

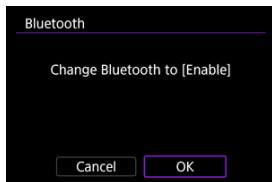

- This screen is not displayed if the Bluetooth setting is already set to [Enable].



- A message is displayed if the camera is already paired with another device. Select [OK] to end the current Bluetooth connection.

6. Press <  >.

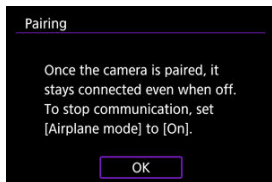

7. Start pairing.



- Press < SET > to start pairing.
- If Camera Connect is not installed, use the smartphone to scan the QR code on the screen, go to Google Play or App Store to install Camera Connect, then press < SET > to start pairing.

8. Start Camera Connect.

- Following the instructions in the app, select the camera for pairing.

9. Establish a Bluetooth connection.



- When a message appears on the smartphone, use the smartphone as indicated.



- Press <  >.

10. Complete the connection process.



- Press < SET >.

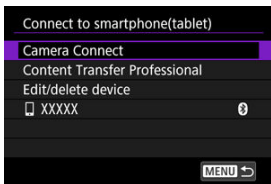

- The name of the connected device is displayed.

⚠ Caution

- Bluetooth connection consumes battery power even after the camera's auto power off is activated. Therefore, the battery level may be low when you use the camera.

Troubleshooting pairing

- Keeping pairing records for previously paired cameras on your smartphone will prevent it from pairing with this camera. Before you try pairing again, remove pairing records for previously paired cameras from your smartphone's Bluetooth settings screen.

11. Tap a Camera Connect function.

- For details on Camera Connect functions, see [Main Functions of Camera Connect](#).
- Tap a Camera Connect function to initiate a Wi-Fi connection. Tap [Join] when a message is displayed to confirm camera connection.

12. Confirm that the devices are connected via Wi-Fi.

- After a Wi-Fi connection is established, the camera screen switches to shooting standby.
- Selecting [✓]: [Connect to smartphone(tablet)] will display the [Communicating] screen on the camera (☑).

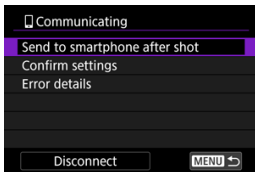

The Wi-Fi connection to a smartphone is now complete.

- To end the Wi-Fi connection, select [Disconnect] on the [Communicating] screen.
- Terminating the Wi-Fi connection will switch the camera to the Bluetooth connection.
- To reconnect, start Camera Connect and tap the function you will use.

[Communicating] screen

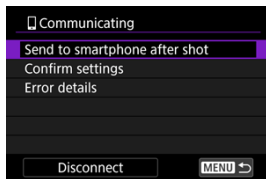

- **Send to smartphone after shot**
Images can be transferred to a smartphone automatically (📷).
- **Confirm settings**
You can check setting details.
- **Error details**
After any Wi-Fi connection errors, you can check the error details (🔧).
- **Disconnect**
Terminates the Wi-Fi connection.

Main Functions of Camera Connect

Images on camera

- Images can be browsed, deleted, or rated.
- Images can be saved on a smartphone.

Remote live view shooting

- Enables remote shooting as you view a live image on the smartphone.

Auto transfer

- Enables camera and app setting adjustment for automatic transfer of your shots (📷).

Bluetooth remote controller

- Enables remote control of the camera from a smartphone paired via Bluetooth. (Not available when connected via Wi-Fi.)
- Auto power off is disabled while you are using the Bluetooth remote controller feature.

Camera settings

- Camera settings can be changed.

Updating camera firmware

- Enables camera firmware updates.





Note

- For details on other functions, you can check the main Camera Connect screen.

Maintaining a Wi-Fi Connection When the Camera Is Off

Even when the camera power switch is set to **<OFF>**, as long as it is paired to a smartphone via Bluetooth, you can use the smartphone to browse images on the camera or perform other operations.

If you prefer not to stay connected to the camera via Wi-Fi or Bluetooth when it is off, either set [: **Airplane mode**] to **[On]** or set [: **Bluetooth settings**] to **[Disable]**.

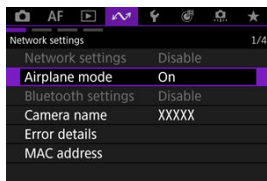



Caution

- This function can no longer be used if the wireless settings are reset or the smartphone connection information is erased.

Connecting to Smartphones without Bluetooth Pairing

This section describes how to establish a direct Wi-Fi connection with a smartphone without Bluetooth pairing.

Connecting to a Smartphone or Tablet

1. Select [: Connect to smartphone(tablet)] ().
2. Select [OK].

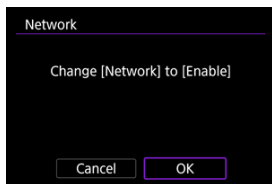

- This screen is not displayed if the network setting is already set to **[Enable]**.

3. Select an option.

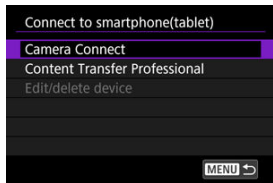

- If you have selected [**Camera Connect**], select [**Use different connection method**] on the [**Camera Connect**] screen.

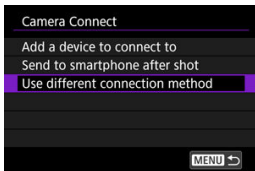

- If you have selected [**Content Transfer Professional**], select [**Add a device to connect to**] on the [**Content Transfer Professional**] screen.

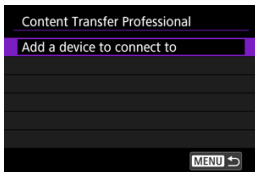

4. Install the app on a smartphone.



- If the app is not installed, use the smartphone to scan the QR code on the screen, go to Google Play or App Store to install the app, then press <  >.

5. Select [New settings].

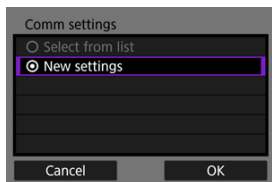

- Select [**OK**] to go to the next screen.
- By selecting [**Select from list**] when settings are already registered on the camera, you can apply the registered settings.

6. Select [OK].

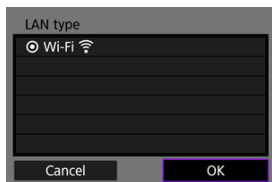

- For instructions on configuring communication functions, see [Basic Communication Settings](#).

7. Save the settings.

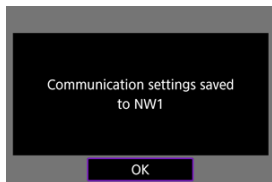

- Press < **SET** >.
- After the communication settings are complete, a message on the camera requests you to connect from the smartphone.

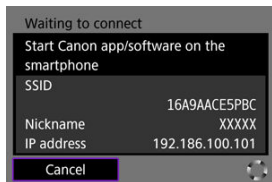

8. Start the app.

- Following the instructions in the app, select the camera.

9. Select [OK].

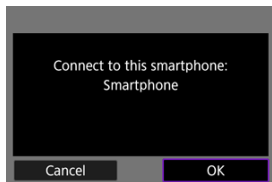

- The [**Communicating**] screen is displayed on the camera ()

Editing/Deleting Devices for Connections

Before editing or deleting connection settings for other devices, end the Wi-Fi connection.

1. Select [**W**]: **Connect to smartphone(tablet)** (🔗).
2. Select **[Edit/delete device]**.

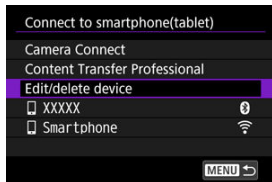

3. Select the intended device.

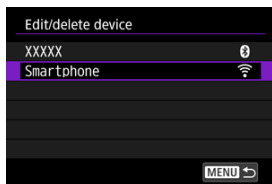

4. Select an option.

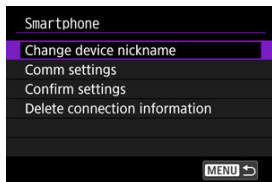

Changing device nicknames

You can change the nickname of devices the camera connects to.

Communication settings

Configurable settings include the wireless LAN and IP address.

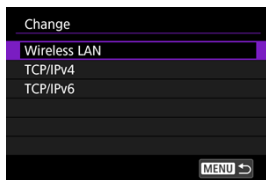

- Selecting [**Wireless LAN**] enables you to change the target SSID, for example.
- Selecting [**TCP/IPv4**] enables you to configure network-related settings such as the IP address.
- Selecting [**TCP/IPv6**] enables you to configure settings used for IPv6 (🔗).
- Depending on the communication setting, not all items may be displayed.

Deleting connection information

You can delete the connection information.

Reconnecting Using Connection Information

The configured connection information can be used to connect again.

1. Select [F7]: [Smartphone] Connect to smartphone(tablet) (Bluetooth icon).
2. Select the device.

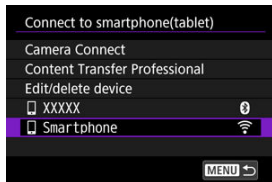

- [Bluetooth icon]: Bluetooth pairing, [Wi-Fi icon]: Wi-Fi connections

3. Select [OK].

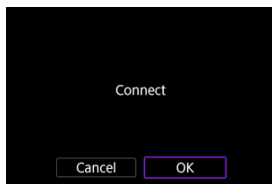



- If you have selected Bluetooth pairing, the following screen is displayed, and you will use the app.



Automatic Image Transfer to a Smartphone as You Shoot

Your shots can be automatically sent to a smartphone. Before following these steps, make sure the camera and smartphone are connected via Wi-Fi.

1. Select []: [] Connect to smartphone(tablet) ().

2. Select [Send to smartphone after shot].

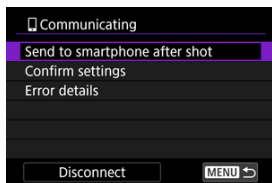

3. Set [Auto send] to [Enable].

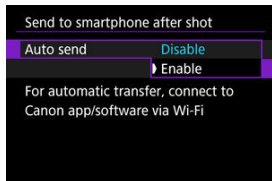

4. Set [Size to send].

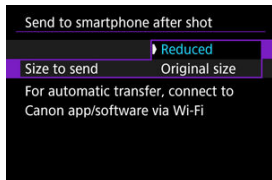

Sending Images to a Smartphone from the Camera

You can use the camera to send images to a smartphone connected via Wi-Fi.

Displaying the menu screen

1. Switch to playback.



2. Press the **< Q >** button (10).

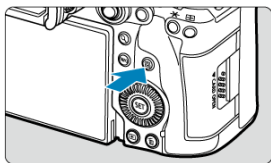

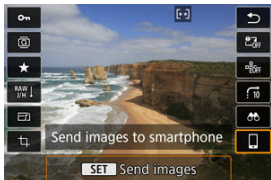

3. Select [Send images to smartphone].



- If you perform this step while connected via Bluetooth, a message is displayed requesting you to establish a Wi-Fi connection. After pressing **< SET >**, tap a Camera Connect function to connect via Wi-Fi, then start again from step 1.

4. Select an image.



- Turn the <  > dial to select images to send, then press <  >.
- Images can be selected by touch from index display ().

5. Press < >.

- The menu is displayed.



Setting the size of images to send

1. Select an option.

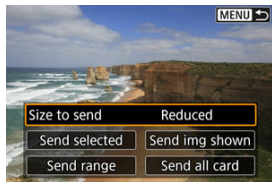

- In [**Size to send**], you can select the size of images to send.

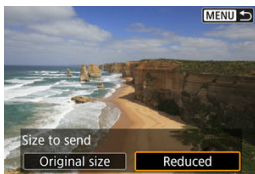

Note

- When sending multiple images, you can also change [**Size to send**] as needed on the confirmation screen before sending.

Sending the current image

1. Select an option.

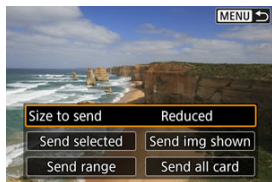

- In [Size to send], you can select the size of images to send.

2. Select [Send img shown].



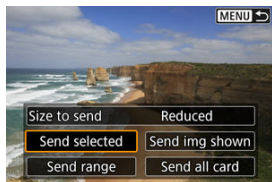

Selecting and sending images

1. Select [Send selected].



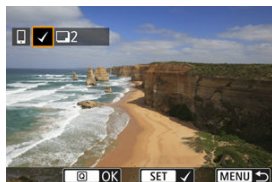

2. Select images to send.

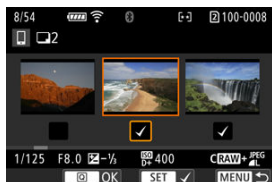

- Turn the <  > dial to select images to send, then press <  >.



- To switch to selecting images from 3-image display, turn the <  > dial counterclockwise. To return to single-image display, turn the <  > dial clockwise.
- After selecting the images to send, press the <  > button.

3. Select an option.

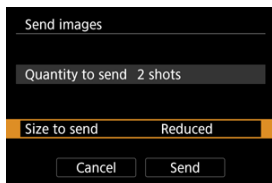

- In [**Size to send**], you can select the size of images to send.

4. Select [**Send**].

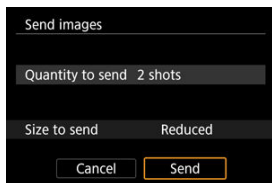

Sending a selected range of images

1. Select [Send range].

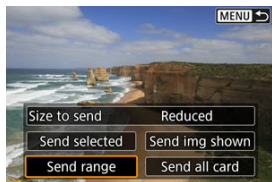

2. Specify the range of images.



- Select the first image (start point).
- Next, select the last image (end point). A checkmark [✓] will be appended to all the images within the range between first and last images.
- To select other images, repeat step 2.
- To change the number of images in index display, turn the <  > dial (✓).

3. Press the < [Q] > button.

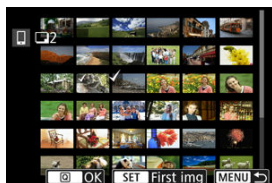

4. Select an option.

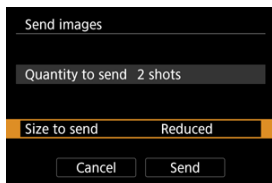

- In **[Size to send]**, you can select the size of images to send.

5. Select **[Send]**.

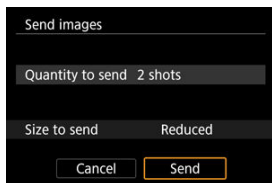

Sending all images on a card

1. Select [Send all card].



2. Select an option.

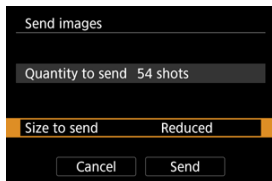

- In [Size to send], you can select the size of images to send.

3. Select [Send].

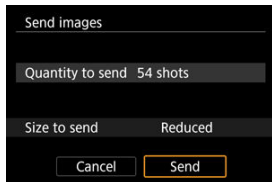

Sending images found by searching

Send all the images that match the search conditions set in [▶]: **Set image search conditions**] at once. For details on [▶]: **Set image search conditions**], see [Setting Image Search Conditions](#).

1. Select [Send all found].

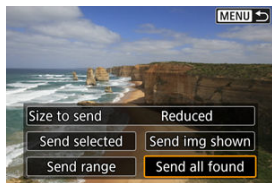

2. Select an option.

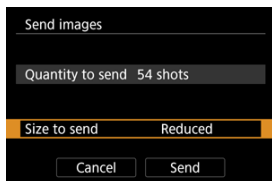

- In **[Size to send]**, you can select the size of images to send.

3. Select [Send].

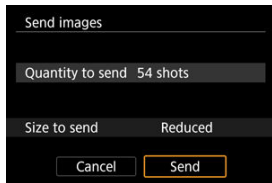

Ending image transfer



- Press the < **MENU** > button on the image transfer screen.
- To end the Wi-Fi connection, select [**Disconnect**] on the [**Communicating**] screen.

! Caution

- During the image transfer operation, a picture cannot be taken even if the camera's shutter button is pressed.

📶 Note

- You can cancel the image transfer by selecting [**Cancel**] during the transfer.
- You can select up to 999 files at a time.
- With a Wi-Fi connection established, disabling the smartphone's power saving function is recommended.
- Selecting the reduced size for still photos applies to all still photos sent at that time.
Note that **S2** size still photos are not reduced.
- When you use a battery to power the camera, make sure it is fully charged.

Live Streaming



[✔ Pairing with a Smartphone via Bluetooth](#)

[✔ Setting Up Streaming](#)

You can live-stream images from the camera.

Check the streaming requirements and terms of service in advance on the streaming site.

Pairing with a Smartphone via Bluetooth

1. Prepare the smartphone ([✔](#)).
2. Select []: [] Connect to smartphone(tablet)] ([✔](#)).
3. Select [OK].

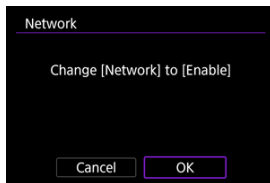

- This screen is not displayed if the network setting is already set to **[Enable]**.

4. Select [Camera Connect].

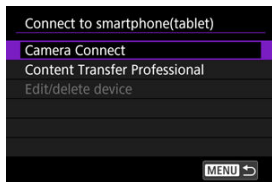

5. Select [Add a device to connect to].

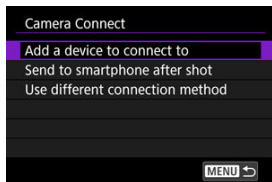

6. Select [OK].

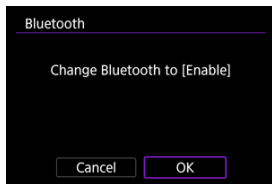

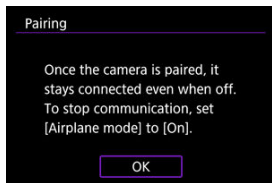

- This screen is not displayed if the Bluetooth setting is already set to [Enable].

7. Press < >.



8. Start pairing.



- Press <  > to start pairing.
- If Camera Connect is not installed, use the smartphone to scan the QR code on the screen, go to Google Play or App Store to install Camera Connect, then press <  > to start pairing.

9. Start Camera Connect.

- Following the instructions in the app, select the camera for pairing.

10. Establish a Bluetooth connection.

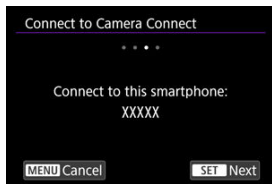

- Press < SET >.

11. Complete the connection process.



- Press < SET >.
- When a message appears on the smartphone, use the smartphone as indicated.

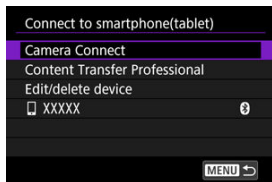

- The name of the connected device is displayed.
- Press the < MENU > button.

Setting Up Streaming

1. Switch to movie recording (📹).
2. Select [📹: **Live streaming**] (📹).
3. Select [New settings].

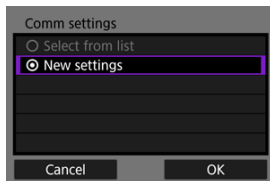

- Select [OK] to go to the next screen.
- By selecting [Select from list] when settings are already registered on the camera, you can apply the registered settings.

4. Select [OK].

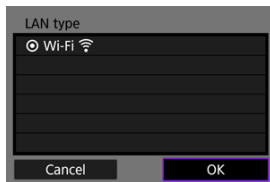

- For instructions on configuring communication functions, see [Basic Communication Settings](#).

5. Complete the streaming settings in Camera Connect.

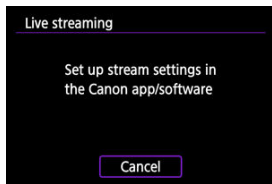

- Select the streaming platform you will use, then configure the settings accordingly.
- You can enter a URL on the screen to select a streaming site.
- Set the streaming quality, based on your communication environment.

6. Start streaming.

- [STBY] is shown on the recording standby screen.
- Use Camera Connect to start and stop streaming. You can also start or stop streaming by pressing the movie shooting button on the camera.

Caution

- Video and audio may be noisy during streaming, depending on the communication environment. Test streaming in advance and check the video and audio quality.
- Try the following if video and audio is noisy or skips. These steps may improve the quality.
 - Bring the camera and access point (wireless router, tethering smartphone, etc.) closer together, change their relative positions, and keep the space between them free of people and objects.
 - Indoors, set up the access point and camera in the same room.
 - Set up away from devices that use the 2.4 GHz band, such as microwave ovens or cordless phones.
- If noise from an external microphone is distracting, try placing the microphone on the side of the camera with the external microphone IN terminal as far from the camera as possible.
- Although selecting 3.5 Mbps as the streaming quality in Camera Connect may enable more stable streaming than with 6 Mbps, image quality will be lower.
- The camera will become warmer during streaming. Use the stand or a tripod, or take other measures to avoid handheld recording. Once the camera becomes hot,  appears on the screen as a warning.
- Note that Canon is in no way responsible for third-party services.
- No image is recorded to the card during streaming (but a card must be in the camera).
- Test streaming in advance to make sure the image is straight and in the correct orientation, and adjust the orientation as needed.
- Be sure to read [Wireless Communication Precautions](#).

Connecting to a Wireless Remote Control

[☑ Deleting Connection Information](#)

[☑ Reconnecting Using Connection Information](#)

This camera can also be connected to Wireless Remote Control BR-E1 (sold separately, [☑](#)) via Bluetooth for remote control shooting.

1. Select [**☑**]: **Connect to Wireless Remote**] ([☑](#)).
2. Select [**Add a device to connect to**].

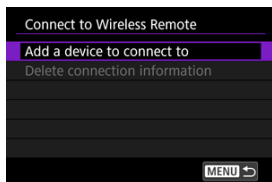

3. Select [OK].

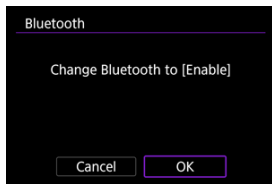

- This screen is not displayed if the Bluetooth setting is already set to [Enable].

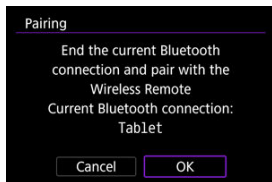

- A message is displayed if the camera is already paired with another device. Select [OK] to end the current Bluetooth connection.

4. Pair the devices.

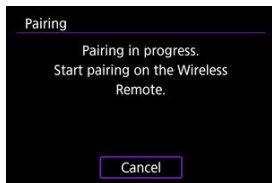

- When the screen shown above appears, press and hold the <W> and <T> buttons on the BR-E1 simultaneously for at least 3 sec.
- Press <SET> after the camera displays [Paired with: *****] (where **** is a unique BR-E1 identifier).



5. Set up the camera for remote shooting.

- For instructions after the pairing is complete, refer to the BR-E1's Instruction Manual.

Caution



- Bluetooth connections consume battery power even after the camera's auto power off is activated.

Note

- When you will not use Bluetooth, setting [: **Bluetooth settings**] to [**Disable**] is recommended ().

Deleting Connection Information

You can delete the connection information. Pairing information for any connected BR-E1 units will be deleted.

1. Select [ Connect to Wireless Remote] ().

2. Select [Delete connection information].



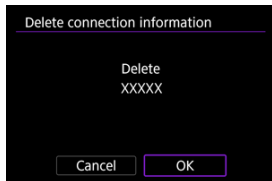

3. Select [OK].



Reconnecting Using Connection Information

When paired via Bluetooth with another device, the camera can use the connection information to reconnect.

1. Select [ Connect to Wireless Remote] ().

2. Select the device.



- The device to connect to changes to the selected device.

3. Press <  >.





Using Camera Control API (CCAPI)

- [✔ Setting a Port Number](#)
- [✔ Configuring User Authentication](#)
- [✔ Configuring the Connection](#)
- [✔ Changing Settings](#)

Before using an application or other product applying the Camera Control API (CCAPI),* prepare the camera for CCAPI control by connecting it to the smartphone, tablet, or computer you will use.

* Camera Control API is an HTTP-based application programming interface for controlling Canon cameras over a network.

Setting a Port Number

1. Select [✓]:  Camera Control API] ().

 - Enter the camera name after the camera displays **[Register a nickname to identify the camera. This nickname will be used for Wi-Fi and Bluetooth connections.]**

2. Select an option.

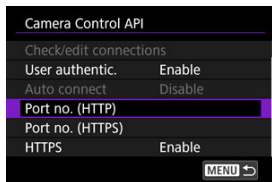

- **Port no. (HTTP)**
The HTTP port number can be changed as needed.
- **Port no. (HTTPS)**
The HTTPS port number can be changed as needed.
- **HTTPS**
Set to **[Disable]** when using HTTP.

Configuring User Authentication

1. Select [Camera Control API] (Ⓜ).

- Enter the camera name after the camera displays **[Register a nickname to identify the camera. This nickname will be used for Wi-Fi and Bluetooth connections.]**

2. Select [User authentic.].

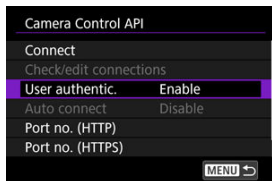

3. Select use of user authentication.

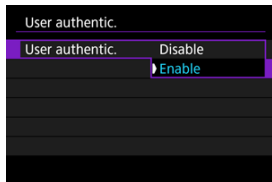

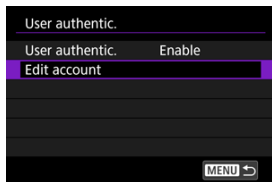

- If you have selected **[Enable]**, enter the **[User name]** and **[Password]** in **[Edit account]**.

4. Select [Edit account].



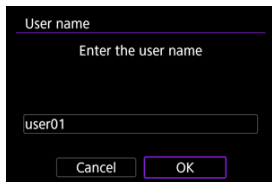

5. Set the user name.

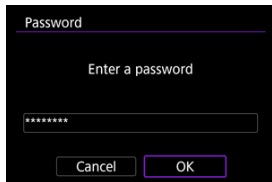

- Press < **SET** > to access the virtual keyboard (), then enter the user name.
- After input, select **[OK]**.

6. Set the password.



- Press < **SET** > to access the virtual keyboard (), then enter the password.
- After input, select **[OK]**.

1. Select [Connect].

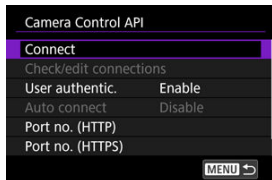

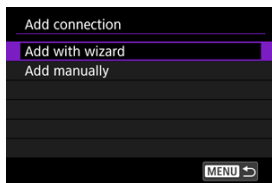

2. Select [Add with wizard].

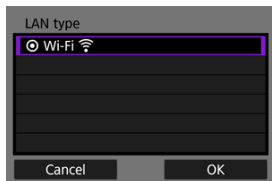

- To configure connection details, select **[Add manually]**.

3. Select an option.



- **[Wired Basic Communication Settings.**

4. Set the user name.

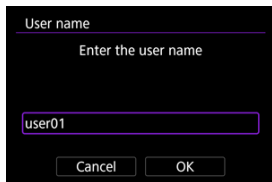

User name

Enter the user name

user01

Cancel OK

- Press < **SET** > to access the virtual keyboard (), then enter the user name.
- Select [**OK**] to go to the next screen.

5. Set the password.

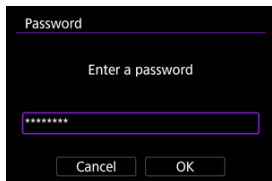

Password

Enter a password

Cancel OK

- Press < **SET** > to access the virtual keyboard (), then enter the password.
- Select [**OK**] to go to the next screen.

6. Establish a Wi-Fi connection.

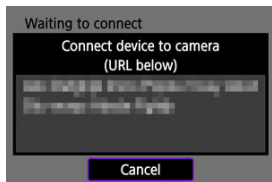

- When the screen above appears on the camera, use the smartphone, computer, or other device to access the indicated URL from the application developed for camera control.

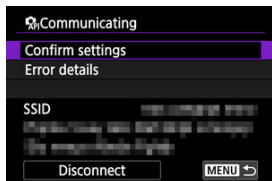

- Display of the screen above on the camera indicates that a connection has been established.
- To end the connection, select [**Disconnect**].

[API] Communicating] screen

The following operations are available from the [API] Communicating] screen.

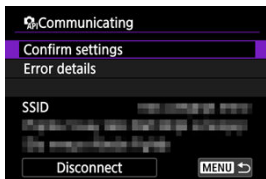

- **Confirm settings**
You can check setting details.
- **Error details**
After any Wi-Fi connection errors, you can check the error details ([🔗](#)).
- **Disconnect**
Terminates the connection.

Changing Settings

You can change the settings when the camera is not connected.

Check/edit connections

Check or edit connection settings.

1. Select [Check/edit connections].

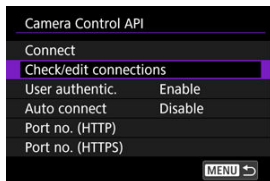

2. Select the intended device.

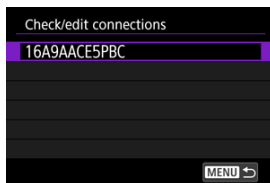

3. Select items to check or change.

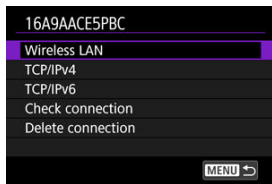

- **Wireless LAN (or Wired)**

When wireless LAN settings have been configured, you can change the SSID (network name) and details such as the connection method, security, and type of encryption.

- **TCP/IPv4**

You can change the TCP/IPv4 settings.

- **TCP/IPv6**

You can change the TCP/IPv6 settings.

- **Check connection**

You can review connection settings.

- **Delete connection**

You can clear the connection settings.

Auto connect

Selecting [**Enable**] will automatically establish a connection the next time the camera starts up after you turn it off.

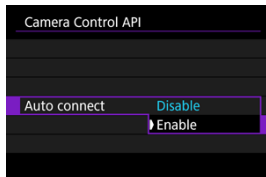

GPS Device Settings

[GPS Receiver GP-E2](#)

[Smartphone](#)

[GPS Connection Display](#)

You can geotag images with GPS Receiver GP-E2 (sold separately) or a smartphone.

GPS Receiver GP-E2

1. Attach GP-E2 to the camera.

- Attach GP-E2* to the camera's hot shoe and turn it on. For details, refer to the GP-E2 Instruction Manual.
* Requires a Multi-Function Shoe Adapter AD-E1 (sold separately).

2. Select [: GPS device settings] ().

3. Select [Select GPS device].

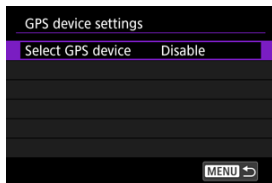

4. Select [GPS receiver].

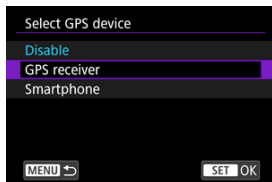

5. Configure GPS device settings.

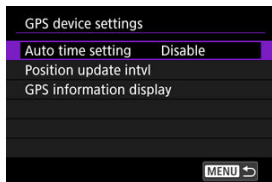

- For details on [**Set up**], refer to the GP-E2 Instruction Manual.

6. Take the picture.

! Caution

Precautions when using GP-E2

- Before use, check the countries and regions where use of GPS is allowed, and follow local regulations.
- Update the GP-E2 firmware to Ver. 2.0.0 or later.
Firmware updating requires an interface cable. For updating instructions, visit the Canon website.
- GP-E2 cannot be connected to the camera with a cable.
- The camera does not record the shooting direction.

Smartphone

Complete these settings after installing the Camera Connect smartphone app (📱).

1. On the smartphone, activate location services.

2. Establish a Bluetooth connection.

- Start Camera Connect and pair the camera and smartphone via Bluetooth.

3. Select [: GPS device settings] (📱).

4. Select [Select GPS device].

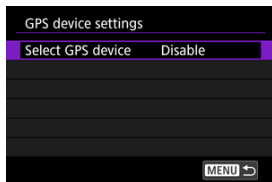

5. Select [Smartphone].

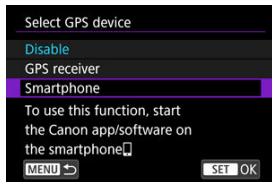

6. Take the picture.

- Images are geotagged with the information from the smartphone.

GPS Connection Display

You can check the status of smartphone location information acquisition in the GPS connection icon on the screens for still photo shooting or movie recording (📷 and 🎥, respectively).

- Gray: Location services are off
- Blinking: Location information cannot be acquired
- On: Location information acquired

For details on how GPS connection status is indicated when GP-E2 is used, refer to the GP-E2 Instruction Manual.

Geotagging images as you shoot

While the screen shows that **[GPS]** is on, the images you capture will be geotagged.



Geotagging information

You can check geotag information by displaying a shot, pressing the <INFO> button to access playback screens with detailed information, and then pressing <⌘> vertically.

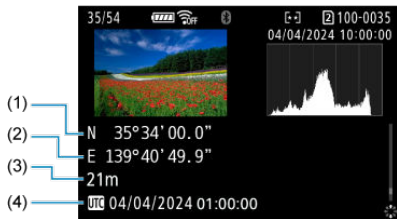

- (1) Latitude
- (2) Longitude
- (3) Elevation
- (4) Coordinated Universal Time (UTC)

⚠ Caution

- The smartphone can acquire location information only while it is paired with the camera via Bluetooth.
- Direction information is not acquired.
- Acquired location information may not be accurate, depending on traveling conditions or smartphone status.
- It may take some time to acquire location information from the smartphone after you turn the camera on.
- Location information is no longer acquired after any of the following operations.
 - Pairing with a wireless remote control via Bluetooth
 - Turning the camera off
 - Quitting Camera Connect
 - Deactivating location services on the smartphone
- Location information is no longer acquired in any of the following situations.
 - The camera power turns off
 - The Bluetooth connection is ended
 - The smartphone's remaining battery level is low



Note

- Movies are tagged with the geotag information acquired when you start recording.
- Coordinated Universal Time, abbreviated as UTC, is essentially the same as Greenwich Mean Time.

Linked Shooting

[Basic Linked Shooting](#)

[Positioning the Cameras](#)

In linked shooting over wireless LAN, you can coordinate shooting by up to 10 receiver cameras with a sender camera that you shoot from.

Note that there is a slight delay in the shutter release timing between the sender and receiver cameras. Moreover, movie recording is not supported.

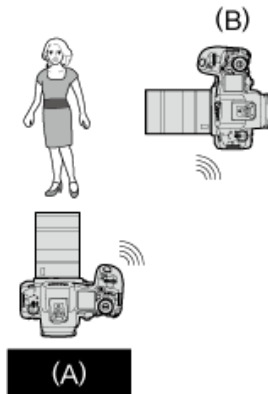

(A) Sender camera

(B) Receiver camera

Note

- For details on cameras or combinations of cameras and accessories you can use in linked shooting, see [Preparing to Use Communication Functions](#).

Basic Linked Shooting

Link the sender and receiver cameras for basic linked shooting.

Preparing the sender camera

First, set up the camera to use as a sender.

1. Select [**⌘**: Network settings] (🔗).
2. Select [**Enable**].

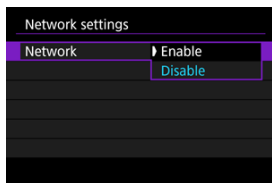

3. Select [**Connection settings**].

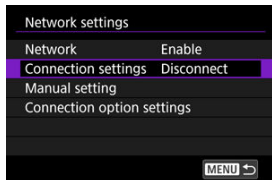

4. Select [LinkedShot].

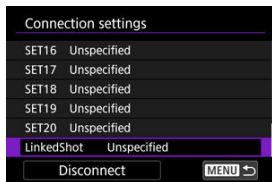

- Use the <  > dial to select [LinkedShot] at the bottom.

5. Select [Create with wizard].

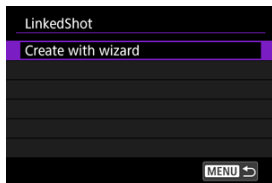

6. Select [Sender].

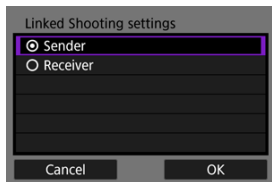

- Select [OK].

7. Select [Auto connect].

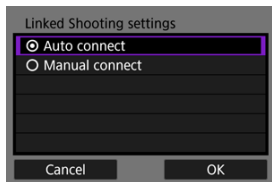

- Select [**OK**].
- After the screen is displayed, the camera is ready.
- Up to nine compatible receiver cameras can be linked when you select [**Manual connect**].

Preparing receiver cameras

Set up cameras to use as receivers.

1. Follow steps 1–5 in [Preparing the sender camera](#).
2. Select **[Receiver]**.

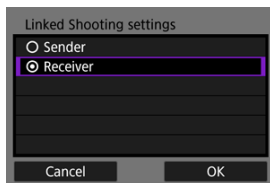

- Select **[OK]** to go to the next screen.

3. Select [OK].

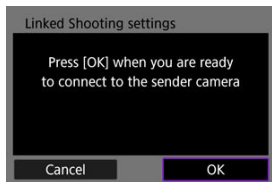

- The following screen is displayed.

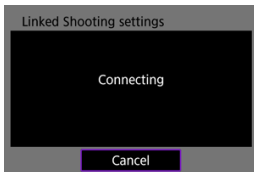

- When using multiple receiver cameras, repeat steps 1–3 on each receiver camera.
- More receivers cannot be added after setup is complete. In that case, you will need to configure the settings again from step 1.
- The number of receiver cameras detected is displayed on the sender camera screen.

Connecting the sender and receiver cameras

Use the sender and receiver cameras to establish a connection.

1. Follow steps 1–7 in [Preparing the sender camera](#) and steps 1–3 in [Preparing receiver cameras](#).
2. On the sender camera, select [OK].

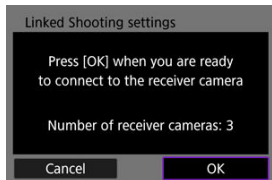

- Check the number of receiver cameras that are connected, then select [OK].
- Once the cameras are connected, the following screen is displayed.

3. Press <  > on all of the cameras.

Sender camera

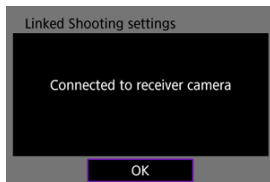

Receiver camera

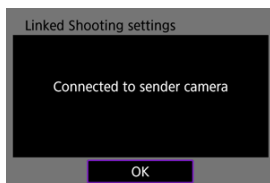

- Display returns to the [Network settings] screen.

Positioning the Cameras

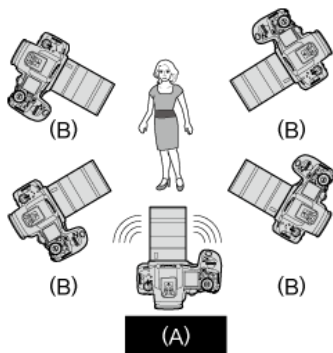

- (A) Sender camera
(B) Receiver camera

- Position receiver cameras where there is an unobstructed line of sight to them from the sender camera.
- Receiver cameras can be positioned up to approx. 50 m from the sender camera. However, the effective range for linked shooting may be shorter depending on wireless communication conditions, which are affected by factors such as camera positioning, the environment of use, and weather conditions.
- Pressing the sender camera shutter button halfway also has the effect of pressing the receiver camera shutter buttons halfway. Similarly, pressing the sender camera shutter button completely has the same effect on receiver cameras, which also shoot.
- There is a slight delay in the shutter release timing between the sender and receiver cameras, and simultaneous shooting is not possible.

⚠ Caution

- Do not use multiple flash units. Although slight, the difference in shutter release timing may cause out-of-sync flash firing and inadequate exposure.



Note

- In linked shooting, pressing the AE lock or depth-of-field preview button executes focusing and metering just as pressing the shutter button halfway does.
- Once you have established a connection between sender and receiver cameras, the settings are retained even after changes such as replacing the batteries.
- If you will no longer use a receiver camera in linked shooting, set **[LinkedShot]** in **[Connection settings]** on the receiver camera to **[Disconnect]**.

Basic Communication Settings

- [Connecting via Wired LAN](#)
- [Connecting via WPS](#)
- [Connecting to Detected Networks](#)
- [Connecting by Entering a Network Name](#)
- [Connecting in Camera Access Point Mode](#)
- [Setting the IP Address Manually](#)
- [Configuring IPv6](#)
- [Registering Sets of Communication Settings as Connection Settings](#)

This section describes how to configure communication settings and register them in **[Comm settings]**.

If communication settings are displayed when you are configuring network features, choose a connection method in the links above and follow the steps on the screen displayed (**[Comm settings]** or **[LAN type]** screen).

Connecting via Wired LAN

Register communication settings that involve a wired LAN as follows. Use of wired LAN with the camera requires Battery Grip BG-R20EP or Cooling Fan CF-R20EP (both sold separately).

Adding the connection with the wizard

1. Select [: Network settings] ().

2. In [Network], select [Enable].

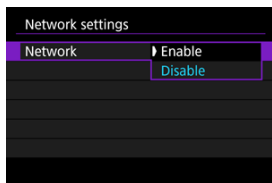

3. Select [Manual setting].

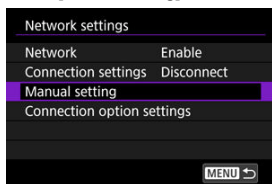

4. Select [Comm settings].

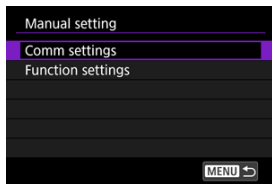

5. Select [NW*].



6. Select [Create with wizard].

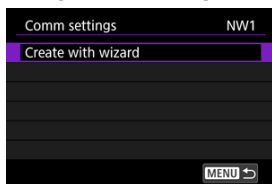

7. Select an option.

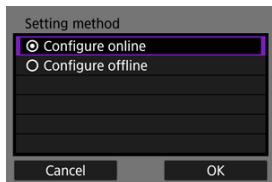

- Select [OK] to go to the next screen.
- Selecting [Configure offline] will keep the camera disconnected from the network after configuration.

8. Select [**Wired**].

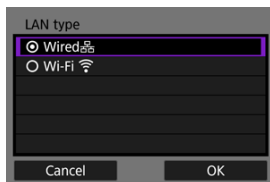

- Select [**OK**] to go to the next screen.

9. Select an option.

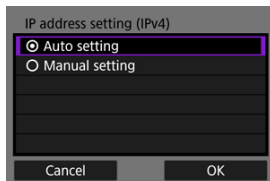

- Select [**OK**] to go to the next screen.
- If you have selected [**Manual setting**], also see [Setting the IP Address Manually](#).

10. Select use of IPv6.

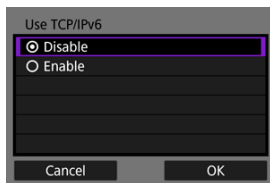

- Select [**OK**] to go to the next screen.
- When selecting [**Enable**], configure IPv6 settings after all settings are complete (②).
- When IPv6 is used, the camera only connects via IPv6. IPv4 connections are disabled.

11. Press < (SET) >.

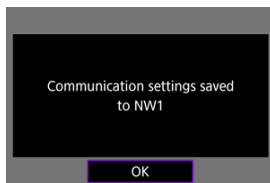

- The communication settings are saved.

Connecting via WPS

Register communication settings with WPS (Wi-Fi Protected Setup) as follows.

WPS connections

Options for connection methods include push-button configuration (PBC) and personal identification number (PIN). When establishing a connection, check the method supported by your access point.

PBC

The camera and access point can be connected simply by pressing the WPS button on the access point.

- Connecting may be more difficult if multiple access points are active nearby. If so, try to connect with **[WPS (PIN mode)]**.
- Check the position of the WPS button on the access point in advance.
- It may take approx. 1 min. to establish a connection.

PIN

An 8-digit identification number indicated on the camera is entered on the access point to establish a connection.

- Even if multiple access points are active nearby, connecting by using this shared identification number is relatively reliable.
- It may take approx. 1 min. to establish a connection.

Adding the connection with the wizard

1. Select [**√**: Network settings] (🔗).
2. In [Network], select [Enable].

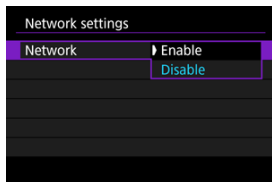

3. Select [Manual setting].

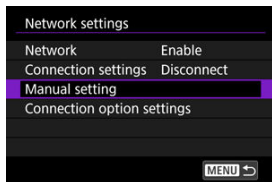

4. Select [Comm settings].

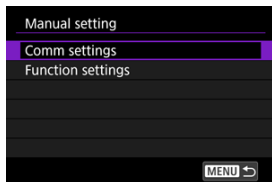

5. Select [NW*].

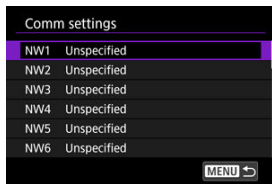

6. Select [Create with wizard].

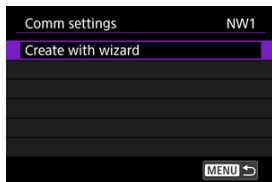

7. Select [Configure online].

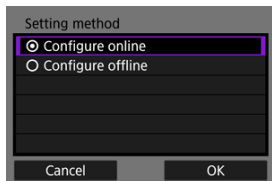

- Select [OK] to go to the next screen.

8. Select [Wi-Fi ].

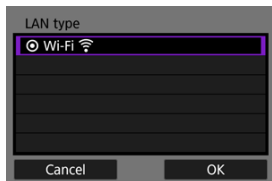

- Select [OK] to go to the next screen.

9. Select [Connect with WPS].

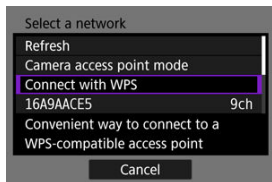

10. Select an option.

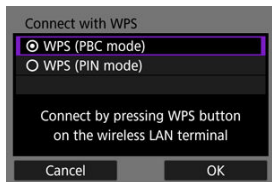

- Select [OK] to go to the next screen.

For [WPS (PBC mode)]

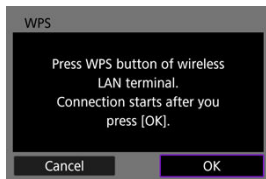

- Press the access point's WPS button. For details on where the button is and how long to press it, refer to the access point user manual.
- Select [OK] to initiate connection with the access point.
- Go to step 12 after the camera is connected to the access point.

For [WPS (PIN mode)]

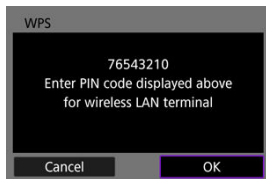

- On the access point, enter the 8-digit PIN code displayed on the camera screen. For instructions on entering PIN codes on the access point, refer to the access point's Instruction Manual.
- Select **[OK]** to go to the next screen.

11. Connect to the access point.

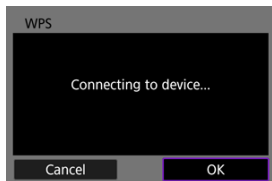

- Select **[OK]** to initiate connection with the access point.
- The following screen is displayed once the camera is connected to the access point.

12. Select [Auto setting].

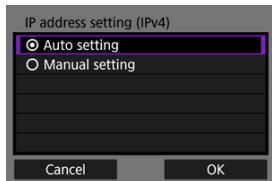

- Select **[OK]** to go to the next screen.
- If you have selected **[Manual setting]**, also see [Setting the IP Address Manually](#).

13. Select use of IPv6.

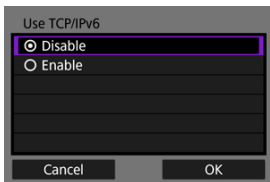

- Select [**OK**] to go to the next screen.
- When selecting [**Enable**], configure IPv6 settings after all settings are complete (Ⓢ).
- When IPv6 is used, the camera only connects via IPv6. IPv4 connections are disabled.

14. Press < Ⓢ >.

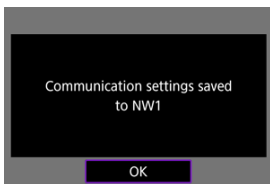

- The communication settings are saved.

Connecting to Detected Networks

Register communication settings by choosing the network name from a list of detected access points.

Adding the connection with the wizard

1. Select [**Network settings**] (🔗).
2. In [**Network**], select [**Enable**].

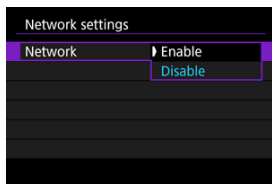

3. Select [**Manual setting**].

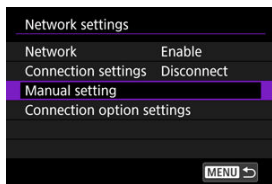

4. Select [**Comm settings**].

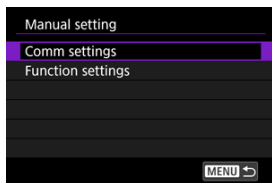

5. Select [NW*].

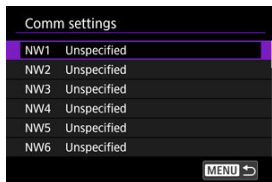

6. Select [Create with wizard].

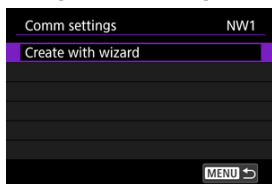

7. Select [Configure online].

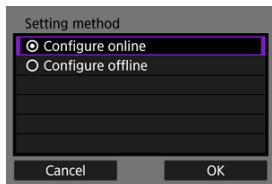

- Select [OK] to go to the next screen.

8. Select [Wi-Fi].

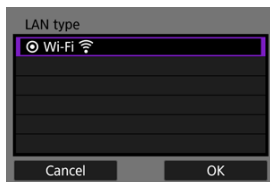

- Select [**OK**] to go to the next screen.

9. Select the network name.

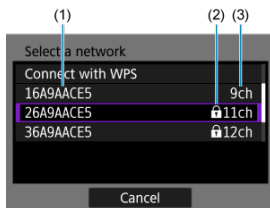

(1) Network names (SSIDs)

(2) Security icon (for access points with encryption)

(3) Channel

- Use the <  > dial to select the name of the network for the connection.
- [**6GHz**] in the list indicates that the access point supports the 6 GHz band.

Note

[Refresh]

- To display [**Refresh**], scroll down the screen in step 9.
- Select [**Refresh**] to search for access points again.

10. Enter the password.

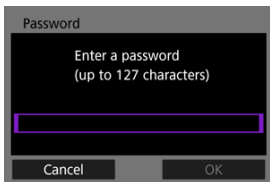

- Press < **SET** > to access the virtual keyboard (), then enter the password.
- Select [**OK**] to initiate connection with the access point.

11. Select [Auto setting].

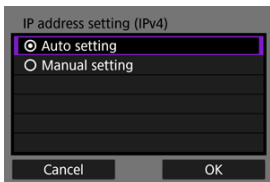

- Select [**OK**] to go to the next screen.
- If you have selected [**Manual setting**], also see [Setting the IP Address Manually](#).

12. Select use of IPv6.

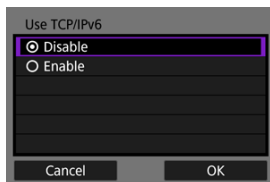

- Select [**OK**] to go to the next screen.
- When selecting [**Enable**], configure IPv6 settings after all settings are complete (②).
- When IPv6 is used, the camera only connects via IPv6. IPv4 connections are disabled.

13. Press < (SET) >.

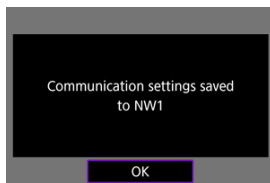

- The communication settings are saved.

Connecting by Entering a Network Name

Register communication settings by choosing the network name from a list of detected access points.

Adding the connection with the wizard

1. Select [**Network settings**] (🔗).
2. In [**Network**], select [**Enable**].

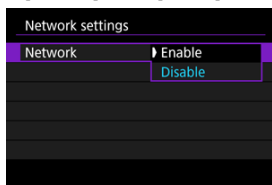

3. Select [**Manual setting**].

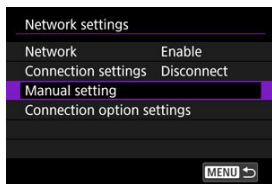

4. Select [**Comm settings**].

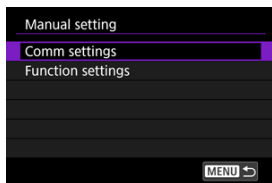

5. Select [NW*].

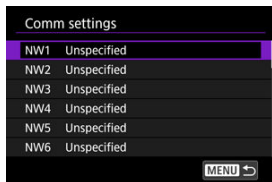

6. Select [Create with wizard].

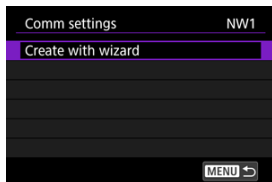

7. Select [Configure offline].

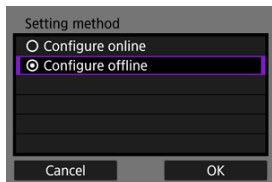

- Select [OK] to go to the next screen.

8. Select [Wi-Fi ].

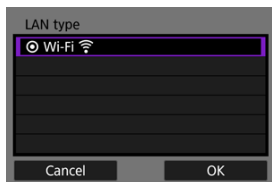

- Select [OK] to go to the next screen.

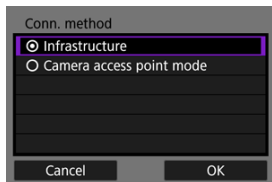

9. Select [Infrastructure].

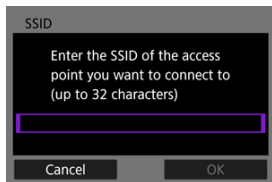

- Select [OK] to go to the next screen.

10. Enter the SSID (network name).



- Press <  > to access the virtual keyboard (), then enter the SSID.
- Select [OK] to go to the next screen.

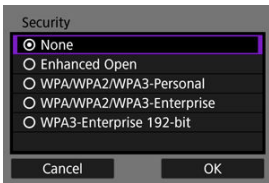

11. Select the type of security.

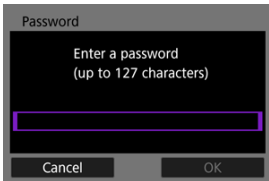

- Select **[OK]** to go to the next screen.
- The same type of security must be set on both the other device and the camera. See [Authentication and data encryption methods](#) for details on types of authentication and encryption.

12. Enter the password.



- Press <  > to access the virtual keyboard (), then enter the password.
- This screen is only displayed for certain types of security.

13. Select an option.

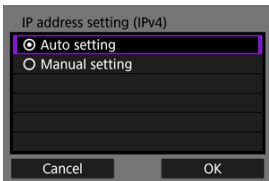

- Select [**OK**] to go to the next screen.
- If you have selected [**Manual setting**], also see [Setting the IP Address Manually](#).

14. Select use of IPv6.

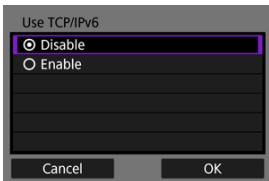

- Select [**OK**] to go to the next screen.
- When selecting [**Enable**], configure IPv6 settings after all settings are complete (🔗).
- When IPv6 is used, the camera only connects via IPv6. IPv4 connections are disabled.

15. Press <  >.

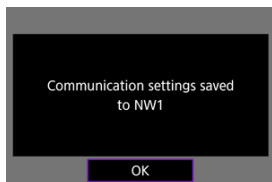

- The communication settings are saved.

Connecting in Camera Access Point Mode

Register communication settings for direct connections between the camera and other devices.

Adding the connection with the wizard

1. Select [**Network settings**] (🔗).
2. In [**Network**], select [**Enable**].

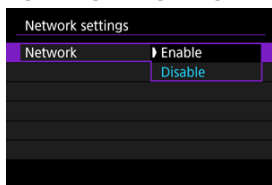

3. Select [**Manual setting**].

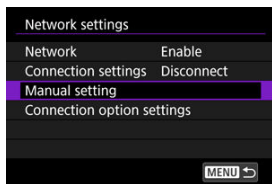

4. Select [**Comm settings**].

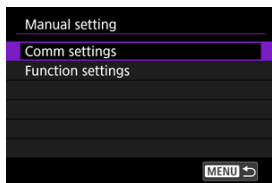

5. Select [NW*].

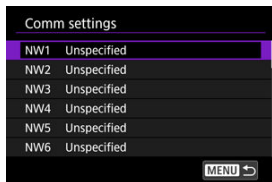

6. Select [Create with wizard].

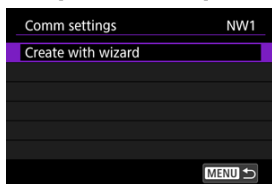

7. Select an option.

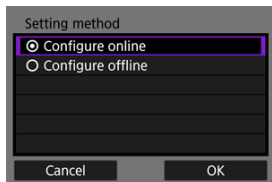

- Select [OK] to go to the next screen.
- Selecting [Configure offline] will keep the camera disconnected from the network after configuration.

8. Select [Wi-Fi ].

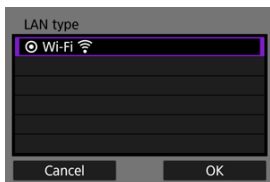

- Select [OK] to go to the next screen.

9. Select [Camera access point mode].

[Configure online] options

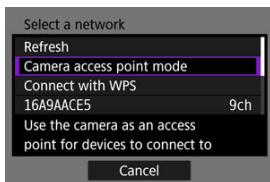

[Configure offline] options

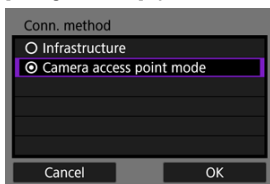

10. Select an option.

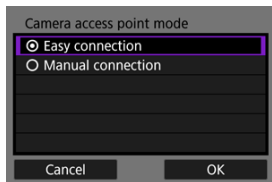

- Select [**OK**] to go to the next screen.
- If you have selected [**Easy connection**], a confirmation screen is displayed (☑).

11. Enter the SSID (network name).

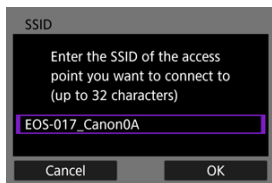

- Press < **SET** > to access the virtual keyboard (☑), then enter the SSID. After input, press < **MENU** >.
- Select [**OK**] to go to the next screen.

12. Select a channel setting option.

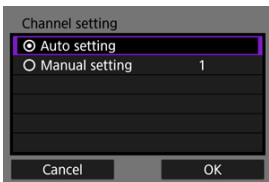

- To specify the settings manually, select [**Manual setting**], then turn the <  > dial.
- Select [**OK**] to go to the next screen.

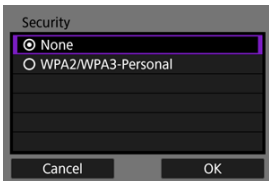

13. Select the type of security.

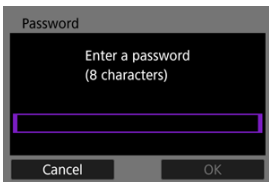

- Select [**OK**] to go to the next screen.
- If you have selected [**None**], the [**IP address setting (IPv4)**] screen is displayed ().
- Available options vary depending on the [**Channel setting**] option you chose.
- The same type of security must be set on both the other device and the camera. See [Authentication and data encryption methods](#) for details on types of authentication and encryption.

14. Enter the password.



- Press <  > to access the virtual keyboard (), then enter the password.

15. Select how to set the IP address.

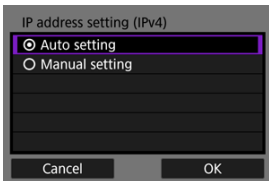

- Select [**OK**] to go to the next screen.
- If you have selected [**Manual setting**], also see [Setting the IP Address Manually](#).

16. Check the SSID and password.

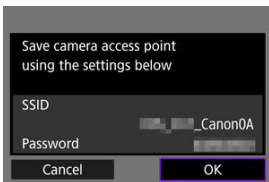

- Select [**OK**] to go to the next screen.

17. Press <  >.

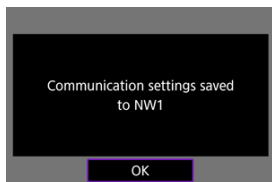

- The communication settings are saved.

Setting the IP Address Manually

Set the IP address as follows if you have selected **[Manual setting]** on the **[IP address setting (IPv4)]** screen.

1. Select **[Manual setting]**.

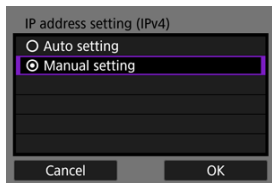

- Select **[OK]** to go to the next screen.

2. Select an option to configure.

IP address setting (IPv4)

IP address	192.168.1.2
Subnet mask	255.255.255.0
Gateway	Disable
DNS address	Disable

Cancel OK

- The items displayed vary depending on the communication function.
- Select an option to access the screen for numerical input.

Gateway

Enable
 Disable

Address

0.0.0.0

Cancel OK

- To use a gateway, select **[Enable]**, then select **[Address]**.

DNS address

Manual setting
 Disable

Address

0.0.0.0

Cancel OK

- To use a DNS address, select **[Manual setting]**, then select **[Address]**.

3. Enter the number.

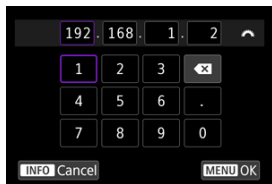

- To set the entered numbers and return to the screen for step 2, press the <MENU> button.

4. Select [OK].

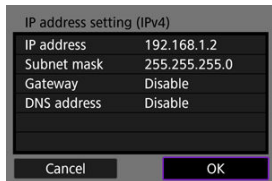

- When you have completed setting the necessary items, select [OK].
- If you are unsure what to enter, see [Checking Network Settings](#) or ask the network administrator or other person in charge of the network.

5. Select use of IPv6.

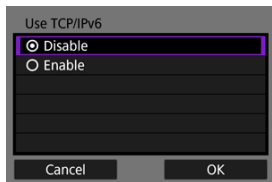

- Select [**OK**] to go to the next screen.
- When selecting [**Enable**], configure IPv6 settings after all settings are complete (②).
- When IPv6 is used, the camera only connects via IPv6. IPv4 connections are disabled.

6. Press < (SET) >.

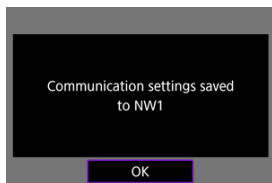

- The communication settings are saved.

Configuring IPv6

To use IPv6, configure the settings manually.

Note

- If you are unsure what to enter, ask the network administrator or other person in charge of the network.

1. Select [: Network settings] ().

2. Select [Manual setting].

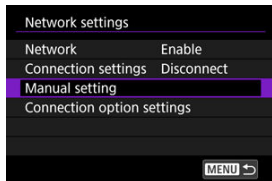

3. Select [Comm settings].

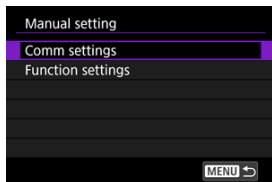

4. Select the communication settings that will use IPv6.

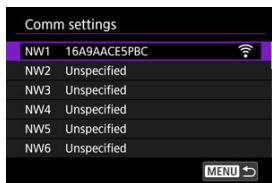

5. Select [Change].

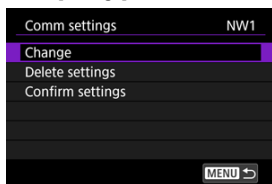

6. Select [TCP/IPv6].

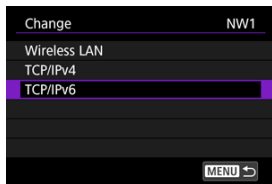

7. Select an option to configure.

TCP/IPv6		NW1
Use TCP/IPv6	Disable	
Manual setting	Disable	
DNS server	Auto assign	
DNS address		
Manual address		
Prefix length	64	
		MENU →

● Use TCP/IPv6

TCP/IPv6		NW1
Use TCP/IPv6	Disable	
	Enable	

- Select **[Enable]** or **[Disable]** for IPv6.

● Manual setting

TCP/IPv6		NW1
Manual setting	Disable	
	Enable	

- To set the IP address manually, select **[Enable]**. **[DNS server]** is set to **[Manual setting]**, and you can configure **[DNS address]**, **[Manual address]**, **[Prefix length]**, and **[Gateway]**.

● DNS server

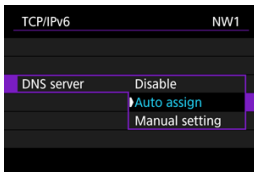

- To set the DNS server IP address manually, select [**Manual setting**].
- Select [**Disable**] if you will not use a DNS server.
- If the setting is currently [**Auto assign**], setting [**Manual setting**] to [**Enable**] changes it to [**Manual setting**].

● DNS address/Manual address/Gateway

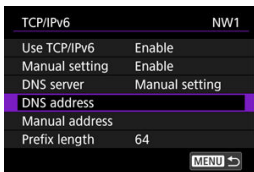

- Select an option and enter the IP address.



● **Prefix length**

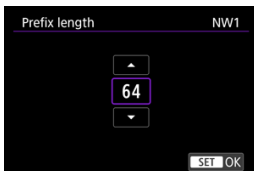

- To set the prefix length, turn the <  > dial to select a value (1–128).

Registering Sets of Communication Settings as Connection Settings

You can register multiple communication settings (multiple Wi-Fi settings, or combinations of wired LAN and Wi-Fi settings) as a single set of connection settings.

With a combination of wired LAN and Wi-Fi settings, communication is restricted to the wired LAN when it is available but otherwise switches to the Wi-Fi connection. When the wired LAN becomes available again, communication is restricted to it.



This section explains how to register connection settings using function and communication settings that are already configured.

Caution

- Settings for multiple networks cannot be configured in camera access point mode settings.

Note

- Use of wired LAN with the camera requires Battery Grip BG-R20EP or Cooling Fan CF-R20EP (both sold separately).

1. Select [: Network settings] ().
2. Select [Connection settings].

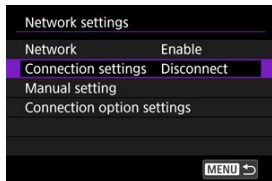

3. Select [SET*].

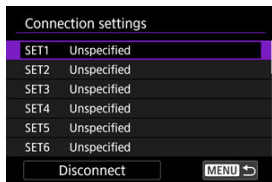

4. Select [Create from list].

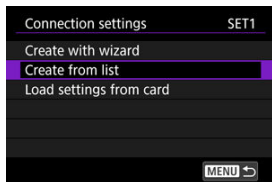

5. Select [Func settings *].

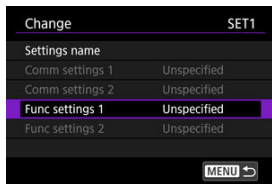

6. Select [Select from list].

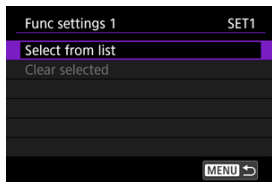

7. Select function settings.

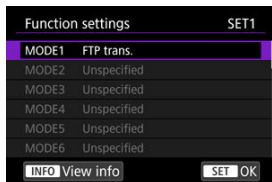

- The function settings are registered, and display returns to the [Change] screen.

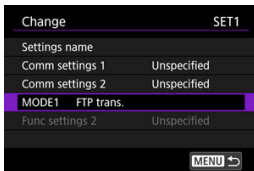

8. Select [Comm settings 1].

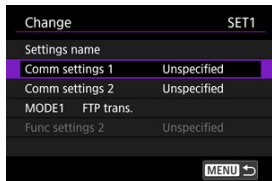

9. Select [Select from list].

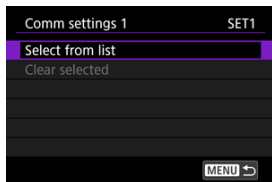

10. Select communication settings.

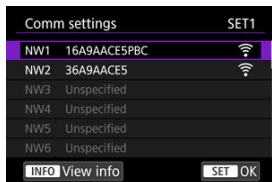

- The first communication settings are registered, and display returns to the [Change] screen.
- You can register wired LAN or Wi-Fi settings in any order.

11. Select [Comm settings 2].

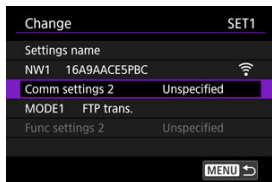

12. Select [Select from list].

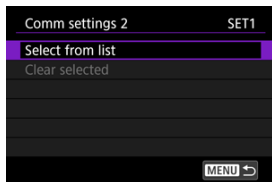

13. Select communication settings.

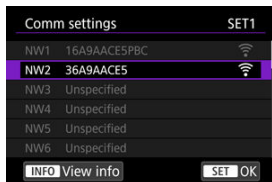

Note

- Select Wi-Fi settings if wired LAN settings are already registered in [Comm settings 1], or select wired LAN settings if Wi-Fi settings are already registered in [Comm settings 1].

14. Exit the screen for changing settings.

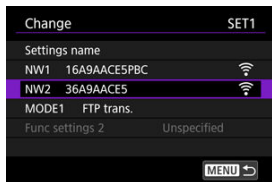

- Press the < MENU > button.

15. Select [Connect].

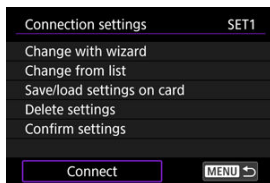

16. Select [OK].

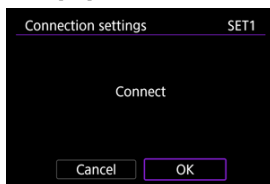

- The connection is initiated.

Checking and Editing Network Settings

- [☑ Ending Connections from the \[Connection settings\] Screen](#)
- [☑ Reconnecting from the \[Connection settings\] Screen](#)
- [☑ Checking and Editing Connection Settings](#)
- [☑ Manually Editing Connection Settings](#)
- [☑ Specifying Connection Options](#)

Ending Connections from the [Connection settings] Screen

1. Select [**☑**: Network settings] ([☑](#)).
2. Select [Connection settings].

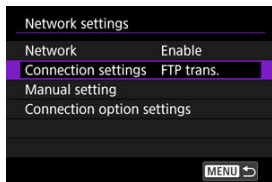

3. Select [Disconnect].

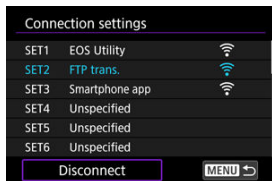

4. Select [OK].

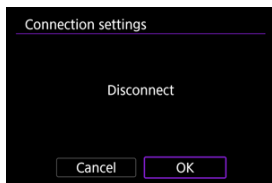

- The devices are disconnected.

Reconnecting from the [Connection settings] Screen

1. Select [**Network settings**] (🔗).
2. Select [**Connection settings**].

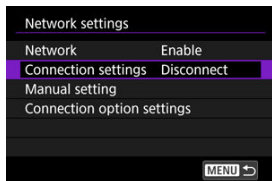

3. Select [**SET***].

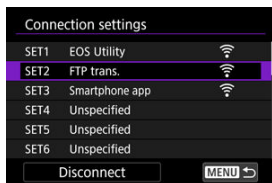

- In the saved settings, select settings to use for the connection.

4. Select [**Connect**].

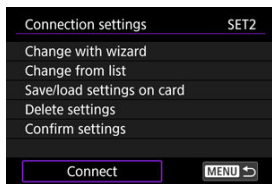

5. Select [OK].

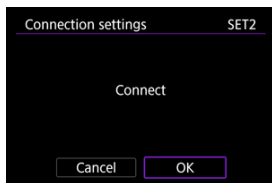

- The devices are connected again.
- If settings were changed on the target device, restore the previous settings to enable connections by the camera.

Checking and Editing Connection Settings

You can check, change, or delete connection settings saved on the camera.

1. Select [**√**: Network settings] (🔗).
2. Select [Connection settings].

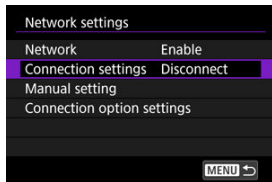

3. Select [SET*].

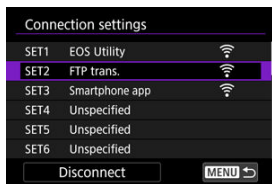

- In the saved settings, select settings to use for the connection.

4. Check or change the settings.

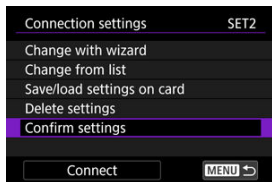

- **Change with wizard/Change from list**

Change connection settings (🔗).

- **Save/load settings on card**

Save connection settings to a card, or load saved connection settings from a card into the camera (🔗).

- **Delete settings**

Select to delete connection settings.

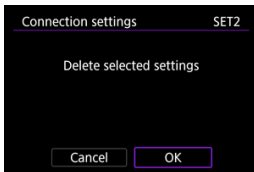

Selecting [OK] deletes the settings.

- **Confirm settings**

Select to check connection settings.

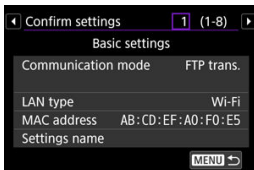

- **Connect**

Select to re-establish a connection (🔗).

Changing connection settings

Settings originally completed using the connection wizard can be changed as follows.

Change with wizard

You can use the connection wizard to change connection settings saved on the camera.

1. Access the [Connection settings] screen.

- Follow steps 1–3 in [Checking and Editing Connection Settings](#).

2. Select [Change with wizard].

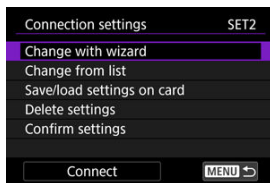

3. Use the connection wizard to change connection settings.

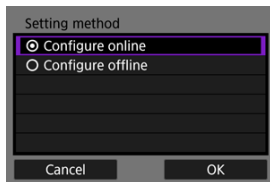

Change from list

You can use communication and function settings saved on the camera to change connection settings saved on the camera. You can also register settings names.

1. Access the [Connection settings] screen.

- Follow steps 1–3 in [Checking and Editing Connection Settings](#).

2. Select [Change from list].

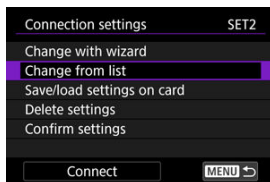

3. Select an option and change setting details as needed.

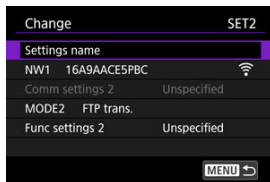

- **Settings name**

Select to name sets of settings. Use the virtual keyboard (⌨) to enter text.

● **NW*/Comm settings***

Select to change, add, or clear communication settings.

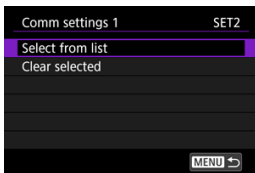

- Selecting [**Select from list**] lists communication settings saved on the camera. Select the communication settings to use. To view communication setting details, select settings and press the < **INFO** > button.
- Selecting [**Clear selected**] clears communication settings with registered connection settings. Select [**OK**] on the confirmation screen.

● **MODE*/Function settings***

Select to change, add, or clear function settings.

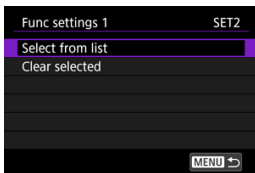

- Selecting [**Select from list**] lists function settings saved on the camera. Select the function settings to use. To view function setting details, select settings and press the < **INFO** > button.
- Selecting [**Clear selected**] clears function settings with registered connection settings. Select [**OK**] on the confirmation screen.

 **Note**

- You can register two sets of communication and function settings to a single set of connection settings. Note that depending on setting details, only one set can be registered in some cases.
- Clearing all function settings also clears communication settings, and the connection settings will be labeled [**Unspecified**].

Saving and loading settings

Connection settings can be saved on a card and applied to other cameras. Connection settings configured on other cameras can also be applied to the camera you will use.

Note

- [🔧: **Save/load cam settings on card**] enables you to save all communication settings on the camera to a card or load all communication settings for another camera from a card.

Saving settings

1. Access the [Connection settings] screen.

- Follow steps 1–3 in [Checking and Editing Connection Settings](#).

2. Select [Save/load settings on card].

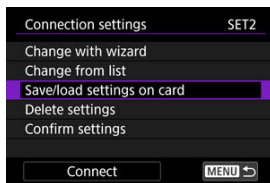

3. Select [Save settings to card].

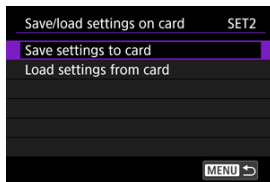

4. Select [OK].

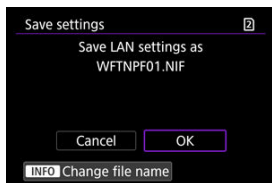

- The file name is determined automatically by the camera: WFTNPF, followed by a number (01 to 40) and the extension NIF. To rename the file as desired, press the <INFO> button.
- The settings are saved to the card.
- The settings file is saved to an area of the card shown when the card is opened (in the root directory).

! Caution

- 40 settings files can be saved on one card from the camera. To save 41 or more, use another card.

1. Access the [Connection settings] screen.

- Follow steps 1–3 in [Checking and Editing Connection Settings](#).

2. Select [Save/load settings on card].

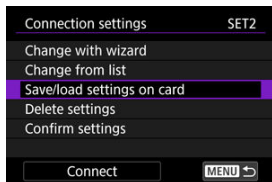

3. Select [Load settings from card].

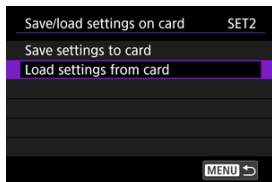

4. Select a settings file.

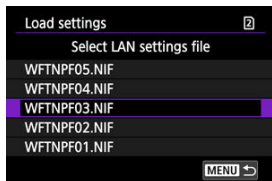

- Select a settings file that matches your network environment.

5. Select [OK].

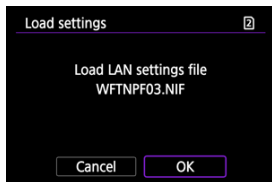

- Information from the settings file is loaded into the selected settings number.

 **Caution**

- Even if a computer or other device is used to save 41 or more settings files on a card, only 40 are displayed on the camera's screen for loading settings. To load 41 or more settings files, load 40 from one card, then load remaining files from another card.

 **Note**

- [: **Save/load cam settings on card**] enables you to save all communication settings on the camera to a card or load all communication settings for another camera from a card.

Manually Editing Connection Settings

You can add, change, or delete communication and function settings saved on the camera. You can also configure settings that are not set using the connection wizard, such as a setting that determines what happens if files with the same name as existing files are sent to the FTP server.

Editing communication settings

1. Select [**√**: Network settings] (Ⓜ).
2. Select [**Manual setting**].

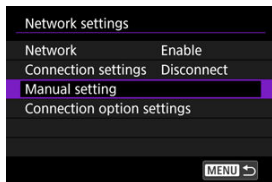

3. Select [**Comm settings**].

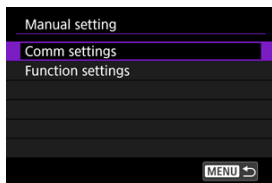

4. Select [NW*].

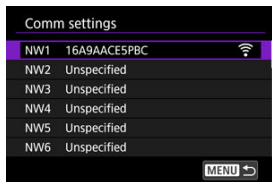

- Select saved settings to edit.

5. Change, delete, or check the settings as needed.

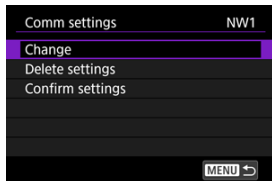

- **Change**

Select to change individual settings in sets of communication settings.

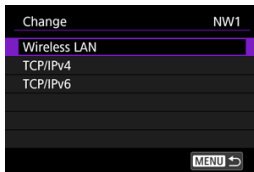

- Selecting [**Wireless LAN**] enables you to change the target SSID, for example.
- Selecting [**TCP/IPv4**] enables you to configure network-related settings such as the IP address.
- Selecting [**TCP/IPv6**] enables you to configure settings used for IPv6 (🔗).
- Depending on the communication setting, not all items may be displayed.

- **Delete settings**

Select to delete communication settings.



Selecting [**OK**] deletes the settings.

- **Confirm settings**

Select to check communication settings.

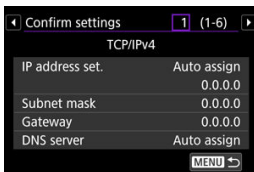

Editing function settings

1. Select [**↖**: Network settings] (🔗).

2. Select [**Manual setting**].

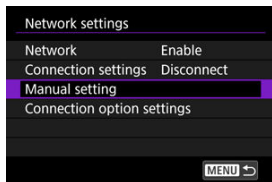

3. Select [**Function settings**].

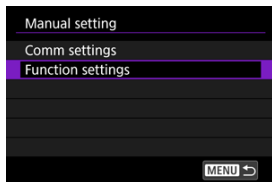

4. Select [**MODE***].

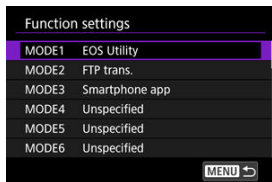

- Select saved settings to edit.

5. Change, delete, or check the settings as needed.

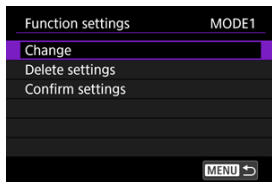

● Change

- Selecting [**Change mode name**] enables you to use the virtual keyboard (📄) to rename the mode.

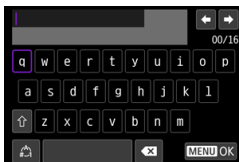
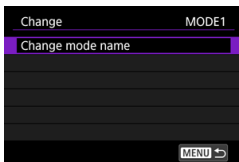

- Selecting [**FTP server**] enables you to configure settings related to the FTP server.

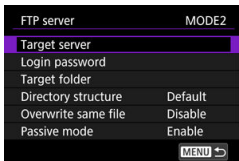
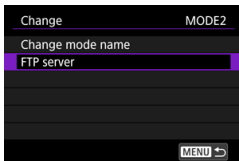

[Directory structure of the target folder](#)

[Overwriting files of the same name](#)

[Passive mode](#)

[Trusting target servers](#)

● Delete settings

Select to delete function settings.

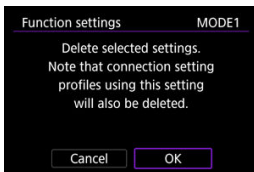

Selecting [**OK**] deletes the settings.

- **Confirm settings**

Select to check function settings.

Confirm settings	1 (1-1)
FTP trans.	
Address	192.168.1.20
Login name	anonymous
FTP mode	FTP
MENU ↩	

Directory structure of the target folder

Configured in **[FTP server]** → **[Directory structure]**.

With **[Default]**, the root folder is used for image storage. If you have created a subfolder in the root folder by changing the **[Target folder]** setting, images are saved in that folder. Selecting **[Camera]** automatically creates a folder structure matching that of the camera's (such as A/DCIM/100EOSR1) in the server's root folder for image storage. If you have created a subfolder in the root folder by changing the **[Target folder]** setting, a folder structure such as A/DCIM/100EOSR1 is automatically created in that folder for image storage.

Overwriting files of the same name

Configured in **[FTP server]** → **[Overwrite same file]**.

With [Overwrite same file] set to [Disable]

If there is already a file with the same name in the target folder on the FTP server, the new file is saved with an extension consisting of an underscore and a number, as in IMG_0003_1.JPG.

When you resend images if initial transfer fails

Even if the camera is configured to overwrite files of the same name, if you resend an image file that could not be transferred initially, the existing file may not be overwritten in some cases. If this happens, the new file is saved with an extension consisting of an underscore, a letter, and a numeral, as in IMG_0003_a1.JPG.

Passive mode

Configured in **[FTP server]** → **[Passive mode]**.

Enable this setting in network environments protected by a firewall. If an Error 41 occurs (Cannot connect to FTP server), setting passive mode to **[Enable]** may enable access to the FTP server.



Trusting target servers

Configured in **[FTP server]** → **[Trust target server]**.

Set to **[Enable]** if you prefer to connect to FTP servers even when trust cannot be established based on the root certificate used. In this case, take suitable security measures.

Specifying Connection Options

You can configure settings used for FTP transfer. Settings are also available for authentication information used in LAN environments with 802.1X authentication.

1. Select [: Network settings] ().
2. Select [Connection option settings].

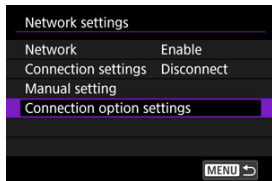

3. Select an option to configure.

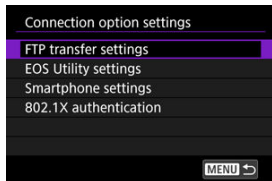

- [FTP transfer settings](#)
- [EOS Utility settings](#)
- [Smartphone settings](#)
- [802.1X authentication](#)

FTP transfer settings

Selecting **[FTP transfer settings]** enables you to configure settings related to FTP transfer and power saving.

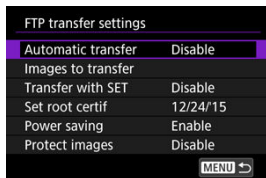

- **Automatic transfer / Images to transfer / Transfer with SET / Set root certif**

For details, see [Transferring Images to an FTP Server](#).

- **Power saving**

When **[Enable]** is set and no image is transferred for a certain period, the camera will log off from the FTP server and disconnect from the LAN. The connection is re-established automatically when the camera is ready for image transfer again. If you prefer not to disconnect from the LAN, set to **[Disable]**.

- **Protect images**

To automatically protect images transferred via FTP, set to **[Enable]** (🔒).

EOS Utility settings

Selecting **[EOS Utility settings]** enables you to configure direct transfer settings.

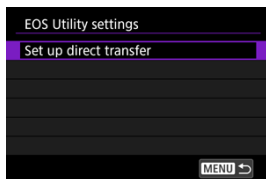

- **Set up direct transfer**

For details, see [Transferring RAW+JPEG or RAW+HEIF Images](#).

Smartphone settings

Selecting **[Send to smartphone after shot]** in **[Smartphone settings]** enables you to set the size of images to send automatically.

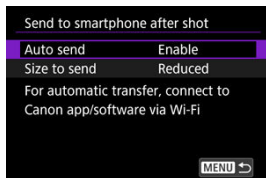

- **Auto send / Size to send**

For details, see [Automatic Image Transfer to a Smartphone as You Shoot](#).

802.1X authentication

Selecting **[802.1X authentication]** enables you to set, check, or delete 802.1X authentication settings, using a setup wizard.

Configure these settings when connecting to networks that require 802.1X authentication.

First, save the certificate for the type of 802.1X authentication used to a card in the camera. File types and names that can be loaded using this function are as follows.

Type	File Name
Root certificate	8021X_R.CER
	8021X_R.CRT
	8021X_R.PEM
Client certificate	8021X_C.CER
	8021X_C.CRT
	8021X_C.PEM
	8021X_C.P12
	8021X_C.PFX
Private key	8021X_C.KEY

Note that the camera supports following protocols.

Protocol	Supported Authentication
EAP-TLS	X.509, PKCS#12
EAP-TTLS	MS-CHAP v2
PEAP	MS-CHAP v2

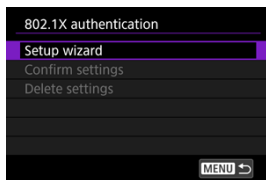

- **Setup wizard**
Follow the wizard to configure the authentication settings.
- **Confirm settings**
Select to check authentication settings.
- **Delete settings**
Select to delete authentication settings. Selecting **[OK]** on the screen displayed deletes the settings.

Airplane Mode

You can temporarily disable Wi-Fi and Bluetooth functions.

1. Select [: Airplane mode] ().

2. Set to [On].

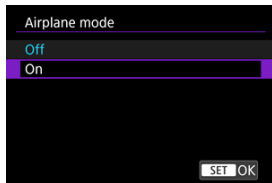



- [] is displayed on the screen.

Note

- [] may not be displayed in still photo shooting, movie recording, or playback, depending on display settings. If it is not displayed, press the <INFO> button repeatedly to access detailed information display.

Bluetooth Settings

1. Select [: Bluetooth settings] ().
2. Select an option.

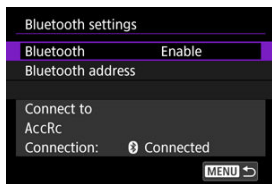

- **Bluetooth**
If you will not use the Bluetooth function, select [**Disable**].
- **Bluetooth address**
You can check the camera's Bluetooth address.
- **Connect to**
You can check the name and communication status of the paired device.

Renaming the Camera

You can change [Camera name], which is displayed on connected devices.

1. Select [**⌨**: Camera name] (**⌨**).
2. Enter text using the virtual keyboard (**⌨**).

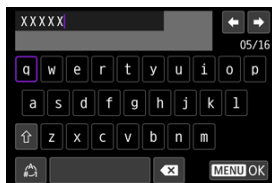

- When you finish entering characters, press the < MENU > button.

3. Select [OK].

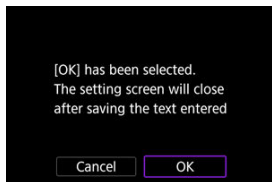

Reference

[Virtual Keyboard Operations](#)

Virtual Keyboard Operations

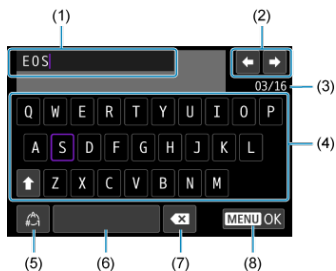

-
- (1) Input area, for entering text

 - (2) Cursor keys, for moving in the input area

 - (3) Current no. of characters/no. available





 - (4) Keyboard

 - (5) Switch input modes

 - (6) Space



 - (7) Delete a character in the input area

 - (8) Exit input

Use <  > or the <  > or <  > dial to move within (2) and (4)–(7). Press <  > to confirm input or when switching input modes.

Error Details

You can display details of errors affecting the camera's wireless communication functions.

1. Select [: Error details] ().

2. Review the error details.

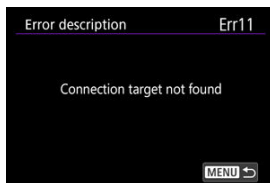





- Details of errors that have occurred are displayed.
- For more information on errors, see [Responding to Error Messages](#).

Responding to Error Messages

Resolve any errors displayed on the camera screen by referring to these examples of corrective actions. When errors occur, the <LAN> lamp on the camera blinks. You can also check error details by accessing [: **Network settings**] → [**Error description**]. Click the following error numbers to jump to the corresponding section.

11	12							
21	22	23						
41	43	44	45	46	48			
61	64	65						
81								
91								
121	125	127						
130	131	132	133	134	135	136	137	
161								

11: Connection target not found

- In the case of [✔]:  Connect to smartphone(tablet)], is the app running?
 - Establish a connection using the app ().
- In the case of [✔]:  Connect to EOS Utility], is EOS Utility running?
 - Start EOS Utility and try to connect again ().
- Are the camera and the access point set to use the same encryption key for authentication?
 - This error occurs if the encryption keys do not match when an access point that encrypts communication is used.
Check upper- and lower-case letters, and make sure the correct encryption key for authentication is set on the camera ().

12: Connection target not found

- Are the target device and access point turned on?
 - Turn on the target device and access point, then wait a while. If a connection still cannot be established, perform the procedures to establish the connection again.

21: No address assigned by DHCP server

What to check on the camera

- **On the camera, the IP address is set to [Auto setting]. Is this the correct setting?**
 - If no DHCP server is used, configure the setting after setting the IP address to **[Manual setting]** on the camera (🔗).

What to check on the DHCP server

- **Is the power of the DHCP server on?**
 - Turn on the DHCP server.
- **Are there enough addresses for assignment by the DHCP server?**
 - Increase the number of addresses assigned by the DHCP server.
 - Remove devices assigned addresses by the DHCP server from the network to reduce the number of addresses in use.
- **Is the DHCP server working correctly?**
 - Check the DHCP server settings to make sure it is working correctly as a DHCP server.
 - If applicable, ask your network administrator to ensure the DHCP server is available.

What to check on the network as a whole

- **Does your network include a router or similar device that serves as a gateway?**
 - If applicable, ask your network administrator for the network gateway address and set it on the camera (🔗, 🔗).
 - Make sure that the gateway address setting is correctly entered on all network devices including the camera.

22: No response from DNS server

What to check on the camera

- **On the camera, the DNS address is set to [Manual setting]. Is this the correct setting?**
 - If no DNS server is used, set the camera's DNS address setting to [Disable] (🔗).
- **On the camera, does the DNS server's IP address setting match the server's actual address?**
 - Configure the IP address on the camera to match the actual DNS server address (🔗, 🔗).

What to check on the DNS server

- **Is the power of the DNS server on?**
 - Turn the DNS server on.
- **Are the DNS server settings for IP addresses and the corresponding names correct?**
 - On the DNS server, make sure IP addresses and the corresponding names are entered correctly.
- **Is the DNS server working correctly?**
 - Check the DNS server settings to make sure the server is working correctly as a DNS server.
 - If applicable, ask your network administrator to ensure the DNS server is available.

What to check on the network as a whole

- **Does your network include a router or similar device that serves as a gateway?**
 - If applicable, ask your network administrator for the network gateway address and set it on the camera (🔗, 🔗).
 - Make sure that the gateway address setting is correctly entered on all network devices including the camera.

23: Device with same IP address exists on selected network

- **Is another device on the camera network using the same IP address as the camera?**
 - Change the camera's IP address to avoid using the same address as another device on the network. Otherwise, change the IP address of the device that has a duplicate address.
 - If the camera's IP address is set to **[Manual setting]** in network environments using a DHCP server, change the setting to **[Auto setting]**.

41: Cannot connect to FTP server

What to check on the camera

- **The camera's proxy server setting is [Enable]. Is this the correct setting?**
 - If no proxy server is used, set the camera's proxy server setting to **[Disable]** (🔗).
- **Do the camera's [Address setting] and [Port No.] settings match those of the proxy server?**
 - Configure the camera's proxy server address and port number to match those of the proxy server (🔗).
- **Are the camera's proxy server settings correctly set on the DNS server?**
 - Make sure the proxy server's **[Address]** is correctly set on the DNS server.
- **On the camera, does the FTP server's IP address setting match the server's actual address?**
 - Configure the IP address on the camera to match the actual FTP server address (🔗).
- **Are the camera and the access point set to use the same password for authentication?**
 - This error occurs if the passwords do not match when a key index has been set on the access point or when you have selected a type of security in the **[Security]** settings that requires password input.
Check upper- and lower-case letters, and make sure the correct password for authentication is set on the camera (🔗).
- **On the camera, does the [Port number setting] for the FTP server match the actual port number of the FTP server?**
 - Configure the same port number (usually 21 for FTP/FTPS or 22 for SFTP) on the camera and FTP server. Configure the port number on the camera to match the actual FTP server port number (🔗).
- **Are the camera's FTP server settings correctly set on the DNS server?**
 - Make sure the FTP server's **[Address]** is correctly set on the DNS server. Make sure the **[Address]** for the FTP server is correctly set on the camera (🔗).

What to check on the FTP server

- **Is the FTP server working correctly?**
 - Configure the computer correctly to function as an FTP server.
 - If applicable, ask your network administrator for the FTP server address and port number, then set them on the camera.
- **Is the power of the FTP server on?**
 - Turn on the FTP server. The server may have been turned off because of an energy-saving mode.
- **On the camera, does the FTP server's IP address setting (in [Address]) match the server's actual address?**
 - Configure the IP address on the camera to match the actual FTP server address (🔗).
- **Is the FTP server configured to restrict access to only some IP addresses?**
 - Check the camera's IP address in [Confirm settings] (🔗) and change the FTP server settings.
- **Is a firewall or other security software enabled?**
 - Some security software uses a firewall to restrict access to the FTP server. Change the firewall settings to allow access to the FTP server.
 - You may be able to access the FTP server by setting [Passive mode] to [Enable] on the camera (🔗).
- **Are you connecting to the FTP server via a broadband router?**
 - Some broadband routers use a firewall to restrict access to the FTP server. Change the firewall settings to allow access to the FTP server.
 - You may be able to access the FTP server by setting [Passive mode] to [Enable] on the camera (🔗).

What to check on the proxy server

- **Is the proxy server on?**
 - Turn on the proxy server.
- **Is the proxy server working correctly?**
 - Check the proxy server settings to make sure the server is working correctly as a proxy server.
 - If applicable, ask your network administrator for the proxy server's address setting and port number, then set them on the camera.

What to check on the network as a whole

- **Does your network include a router or similar device that serves as a gateway?**
 - If applicable, ask your network administrator for the network gateway address and set it on the camera (🔗, 🔗).
 - Make sure that the gateway address setting is correctly entered on all network devices including the camera.

43: Cannot connect to FTP server. Error code received from server.

What to check on the proxy server

- **Is the proxy server on?**
 - Turn on the proxy server.
- **Is the proxy server working correctly?**
 - Check the proxy server settings to make sure the server is working correctly as a proxy server.
 - If applicable, ask your network administrator for the proxy server's address setting and port number, then set them on the camera.

What to check on the network as a whole

- **Does your network include a router or similar device that serves as a gateway?**
 - If applicable, ask your network administrator for the network gateway address and set it on the camera (🔗, 🔗).
 - Make sure that the gateway address setting is correctly entered on all network devices including the camera.

What to check on the FTP server

- **Have you exceeded the maximum number of FTP server connections?**
 - Disconnect some network devices from the FTP server or increase the maximum number of connections.

44: Cannot disconnect FTP server. Error code received from server.

- **This error occurs from a failure to disconnect from the FTP server for some reason.**
 - Restart the FTP server and camera.

45: Cannot login to FTP server. Error code received from server.

What to check on the camera

- **On the camera, is the [Login name] set correctly?**
 - Check the login name for accessing the FTP server. Check upper- and lower-case letters, and make sure the correct login name is set on the camera (🔗).
- **On the camera, is the [Login password] set correctly?**
 - When a login password is set on the FTP server, check upper- and lower-case letters, and make sure the correct login password is set on the camera (🔗).

What to check on the FTP server

- **Do the user rights for the FTP server allow reading, writing, and log access?**
 - Configure the FTP server's user rights to allow reading, writing, and log access.
- **Is the folder specified as the transfer destination on the FTP server named with ASCII characters?**
 - Use ASCII characters for the folder name.

46: For the data session, error code received from FTP server

What to check on the FTP server

- **The connection was terminated by the FTP server.**
 - Restart the FTP server.
- **Do the user rights for the FTP server allow reading, writing, and log access?**
 - Configure the FTP server's user rights to allow reading, writing, and log access.
- **Do user rights allow access to the target folder on the FTP server?**
 - Configure the user rights for access to the target folder on the FTP server to allow saving images from the camera.
- **Is the power of the FTP server on?**
 - Turn on the FTP server. The server may have been turned off because of an energy-saving mode.
- **Is the hard disk of the FTP server full?**
 - Increase available space on the hard disk.

48: Security of the connection to the target server cannot be verified. If you trust this server and connect, set [Trust target server] to [Enable].

- **This error occurs from a failure to confirm security of the target server connection when connecting via FTPS.**
 - Confirm that the certificate is set correctly.
 - Change [Trust target server] to [Enable] if you prefer to trust target servers regardless of certificate settings.

61: Selected SSID wireless LAN network not found

- **Are any obstacles blocking the line of sight between the camera and the antenna of the access point?**
 - Move the antenna of the access point to a position clearly visible from the point of view of the camera.

What to check on the camera

- **Does the SSID set on the camera match that of the access point?**
 - Check the SSID at the access point, then set the same SSID on the camera (🔗).

What to check at the access point

- **Is the access point turned on?**
 - Turn on the power of the access point.
- **If filtering by MAC address is active, is the MAC address of the camera in use registered at the access point?**
 - Register the MAC address of the camera used to the access point (🔗).

64: Cannot connect to wireless LAN terminal

- **Are the camera and the access point set to use the same encryption method?**
 - The camera supports AES encryption (🔗).
- **If filtering by MAC address is active, is the MAC address of the camera in use registered at the access point?**
 - Register the MAC address of the camera used to the access point. The MAC address can be checked on the [MAC address] screen (🔗).

65: Wireless LAN connection lost

- **Are any obstacles blocking the line of sight between the camera and the antenna of the access point?**
 - Move the antenna of the access point to a position clearly visible from the point of view of the camera.
- **The wireless LAN connection was lost, for some reason, and the connection cannot be restored.**
 - The following are possible reasons: excessive access to the access point from another device, a microwave oven or similar appliance in use nearby (interfering with IEEE 802.11b/g/n/ax (2.4 GHz band)), or influence of rain or high humidity.

81: Wired LAN connection lost

- **Is the LAN cable securely connected?**
 - Reconnect the LAN cable between the camera and server. Because the cable may be severed, try using another cable to connect the devices.
- **Is the hub or router on?**
 - Turn on the hub or router.
- **Is the server on?**
 - Turn on the server. The server may have been turned off because of an energy-saving mode.

91: Other error

- **A problem other than error code number 11 to 81 occurred.**
 - Turn the camera's power switch off and on.

121: Not enough free space on server

- **The target Web server does not have enough free space.**
 - Delete unnecessary images on the Web server, check the free space on the Web server, then try sending the data again.

125: Check the network settings

- **Is the network connected?**
 - Check the connection status of the network.

127: An error has occurred

- **A problem other than error code number 121 to 126 occurred while the camera is connected to the Web service.**
 - Try again to establish the Wi-Fi connection to image.canon.

130: The server is currently busy Please wait a moment and try again

- **The image.canon site is busy at the moment.**
 - Try accessing image.canon over Wi-Fi again later.

131: Try again

- **An error occurred when connecting to image.canon over Wi-Fi.**
 - Try again to establish the Wi-Fi connection to image.canon.

132: Error detected on server

Try again later

- **The image.canon site is currently offline for maintenance.**
 - Try accessing image.canon over Wi-Fi again later.

133: Cannot log in to Web service

- **An error occurred when signing in to image.canon.**
 - Check the image.canon settings.
 - Try accessing image.canon over Wi-Fi again later.

134: Set the correct date and time

- **The date, time, and time zone settings are incorrect.**
 - Check the [: **Date/Time/Zone**] settings.

135: Service is not available because image.canon web link settings being cleared. Clear the web link settings on the camera and try settings again.

- **The settings for image.canon were changed.**
 - Check the image.canon settings.

136: The QR code shown on the camera was not scanned correctly by the dedicated app. Try camera web link setup again.

- **The QR code was not scanned correctly by the smartphone.**
 - Reconfigure camera web link settings and scan the QR code displayed again on the camera.

137: The QR code shown on the camera has expired. Try camera web link setup again.

- **The QR code displayed has expired.**
 - Reconfigure camera web link settings and scan the QR code displayed again on the camera.

161: An error has occurred

- **A streaming error has occurred.**
 - Check the streaming settings.
 - Try streaming again.



Troubleshooting Guide

Troubleshoot camera issues by checking the camera and connected devices as described in this section. If troubleshooting does not resolve the problem, contact a Canon Service Center for product information and advice on product handling.

Cannot transfer images to an FTP server.

- Transfer is paused in the following cases.
 - Movie recording in progress
 - Pre-recording in progress
 - [: Standby: Low res.] is set to [Off]

Cannot perform linked shooting.

- When performing linked shooting, set the still photo shooting/movie recording switch to <  >.
Linked shooting is not possible with the still photo shooting/movie recording switch set to <  >.

The camera heats up, and the transmission rate drops.

- Continuous wireless operation over an extended period in high temperatures may cause the camera's internal temperature to rise and slow down transfers.

Wireless Communication Precautions

- [Distance Between the Camera and the Smartphone](#)
- [Installation Location of Access Point Antenna](#)
- [Nearby Electronic Devices](#)
- [Precautions for Using Multiple Cameras](#)

If the transmission rate drops, the connection is lost, or other problems occur when using the wireless communication functions, try the following corrective actions.

Distance Between the Camera and the Smartphone

If the camera is too far from the smartphone, a Wi-Fi connection may not be established even when Bluetooth connection is possible. In this case, bring the camera and the smartphone closer together, then establish a Wi-Fi connection.

Installation Location of Access Point Antenna

- When using indoors, install the device in the room where you are using the camera.
- Install the device where people or objects do not come between the device and the camera.

Nearby Electronic Devices

If the Wi-Fi transmission rate drops because of the influence of the following electronic devices, stop using them or move further away from the devices to transmit communication.

- The camera communicates over Wi-Fi via IEEE 802.11b/g/n/ax using radio waves in the 2.4 GHz band. For this reason, the Wi-Fi transmission rate will drop if there are Bluetooth devices, microwave ovens, cordless telephones, microphones, smartphones, other cameras, or similar devices operating on the same frequency band nearby.

Precautions for Using Multiple Cameras

- When connecting multiple cameras to one access point via Wi-Fi, make sure the cameras' IP addresses are different.
- When multiple cameras are connected to one access point via Wi-Fi, the transmission rate drops.
- When there are multiple IEEE 802.11b/g/n/ax (2.4 GHz band) access points, leave a gap of five channels between each Wi-Fi channel to reduce radio wave interference. For example, use channels 1, 6, and 11, channels 2 and 7, or channels 3 and 8.

Security

If security settings have not been properly set, the following problems may occur.

- **Transmission monitoring**
Third parties with malicious intent may monitor wireless LAN transmissions and attempt to acquire the data you are sending.
- **Unauthorized network access**
Third parties with malicious intent may gain unauthorized access to the network you are using to steal, modify, or destroy information. Additionally, you could fall victim to other types of unauthorized access such as impersonation (where someone assumes an identity to gain access to unauthorized information) or springboard attacks (where someone gains unauthorized access to your network as a springboard to cover their tracks when infiltrating other systems).

It is recommended to make use of the systems and functions to thoroughly secure your network, preventing these types of problems from occurring.

Checking Network Settings

Windows

Open the Windows **[Command Prompt]**, then enter `ipconfig/all` and press the <Enter> key. In addition to the IP address assigned to the computer, the subnet mask, gateway, and DNS server information are also displayed.

macOS

In macOS, open the **[Terminal]** application, enter `ifconfig -a`, and press the <Return> key. The IP address assigned to the computer is indicated in the **[enX]** item (X: number) next to **[inet]**, in the format `****.***.***.****`.

For information about the **[Terminal]** application, refer to the macOS help.

To avoid using the same IP address for the computer and other devices on the network, change the rightmost number when configuring the IP address assigned to the camera in the processes described in [Setting the IP Address Manually](#).

Example: 192.168.1.10

Wireless Communication Status

Wireless communication status can be checked on the screen.

Quick Control screen

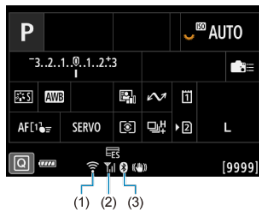











Information display screen during playback





- (1) Wi-Fi function
- (2) Wireless signal strength
- (3) Bluetooth function

Wi-Fi function indicator



Communication Status		Appearance on the Screen	
		Wi-Fi Function	Wireless Signal Strength
Not connected	When set to [Network: Disable]		Not displayed
	When set to [Network: Enable]		
Connecting		 (blinking)	
Connected			
Sending data			
Connection error		 (blinking)	

Bluetooth function indicator

Connection Status		Appearance on the Screen
Not connected	When set to [Bluetooth: Disable]	Not displayed
	When set to [Bluetooth: Enable]	
Connected		

Checking the MAC Address

You can check the camera's MAC address.

1. Select [: MAC address] ().

2. Check the MAC address.



- A QR code with the [**Wi-Fi**] and [**Wired**] MAC addresses, product name, serial number, and file name is displayed.

App Selection for USB Connections

By connecting the camera to a smartphone or computer with the interface cable, you can transfer images or import images to the smartphone or computer.

1. Select [MENU]: Choose USB connection app (🔗).
2. Select an option.

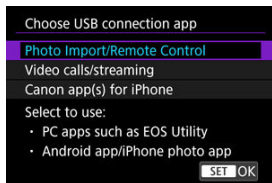

- **Photo Import/Remote Control**

Select if you will use EOS Utility after connecting to a computer, or if you will use Android apps or the iOS version of Photos.

- **Video calls/streaming**

Select if you will use UVC/UAC-compatible applications after connecting to a computer.

After selecting [**Video calls/streaming**], use the interface cable to connect to the computer, then start the application.

The resolution and frame rate of image output is 2K (1920×1080) at 30 fps.

Audio output is LPCM/16bit/2CH (channels 1 and 2), even with [📷: **Audio format**] set to [**LPCM/24bit/4CH**].

- **Canon app(s) for iPhone**

Select if you will use an iOS app.

For details on the cables required to connect the camera to smartphones, visit the Canon website (🔗).

⚠ Caution

- For [**Video calls/streaming**], consider using an optional household power outlet accessory when using the camera over extended periods.

Save/Load Communication Settings on Card

Settings on the wireless features tab can be saved on a card and applied to other cameras. Settings configured on the wireless features tab on other cameras can also be applied to the camera you will use.

Note

- [🔑: **Save/load cam settings on card**] enables you to save all communication settings on the camera to a card or load all communication settings for another camera from a card.

Saving settings

1. Select [🔑: **Save/load comm. settings on card**] (🔑).
2. Select [Save to card].

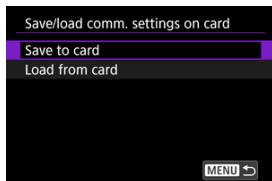

3. Select [OK].

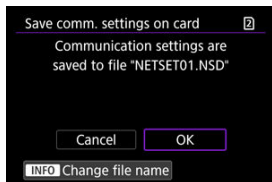

- The file name is set automatically by the camera. To rename the file as desired, press the <INFO> button.
- The settings are saved to the card.
- The settings file is saved to an area of the card shown when the card is opened (in the root directory).

Note

- Up to ten camera settings files can be saved on a card. If a card already has ten camera settings files, either overwrite existing files or use a different card.

1. Select [**✓**: Save/load comm. settings on card] (2).
2. Select [Load from card].

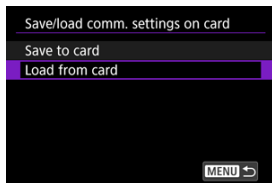

3. Select a settings file.

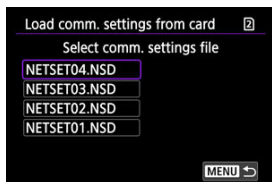

4. Select [OK].



- Information from the settings file is loaded.

 **Caution**

- Even if a computer or other device is used to save more than 10 settings files on a card, only 10 are displayed on the camera's screen for loading settings. When you have more than 10 settings files, divide them among multiple cards so that each card has no more than 10.
- Settings files saved by other camera models cannot be loaded.
- It may not be possible to load settings files that were saved by a camera with a different firmware version.

Resetting Communication Settings

All settings of network features can be cleared. This can prevent the information from being leaked if you lend the camera or transfer ownership.

1. Select [**√**: Reset communication settings] (🔗).
2. Select [OK].



⚠ Caution

- If you have paired the camera with a smartphone, on the smartphone's Wi-Fi settings screen, remove the Wi-Fi connection information of the camera for which you restored default wireless communication settings.

Set-up

This chapter describes menu settings on the set-up [🔧] tab.

☆ to the right of titles indicates functions only available in [Fv], [P], [Tv], [Av], [M], or [BULB] mode.

- [Tab Menus: Set-up](#)
- [Selecting Cards for Recording/Playback](#)
- [Folder Settings](#)
- [Still Photo File Numbering](#)
- [Movie Clip Numbering](#)
- [File Naming](#)
- [Card Formatting](#)
- [Auto Rotate](#)
- [Adding Orientation Information to Movies](#)
- [Date/Time/Zone](#)
- [Language](#)
- [System Frequency](#)
- [Help](#)
- [Beeps](#)
- [Volume](#)
- [Audio Monitor](#)
- [Screen Brightness](#)
- [Viewfinder Brightness](#)
- [Screen and Viewfinder Color Tone](#)
- [Fine-Tuning Viewfinder Color Tone](#)
- [Screen and Viewfinder Display](#)
- [UI Magnification](#)
- [HDMI Resolution](#)
- [Cooling Fan Settings](#)
- [Shutter at Shutdown](#)
- [Sensor Cleaning](#)
- [Power Saving](#)
- [Resetting the Camera](#)☆
- [Custom Shooting Mode \(C1–C3\)](#)☆
- [Save/Load Camera Settings on Card](#)☆
- [Battery Information](#)

- [Copyright Information](#)☆
- [Other Information](#)

Tab Menus: Set-up

● File/card setting

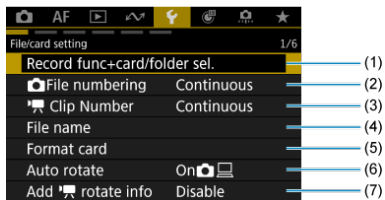

- (1) Record func+card/folder sel.
- [Selecting Cards for Recording/Playback](#)
 - [Folder Settings](#)
- (2) [File numbering](#)
- (3) [Clip Number](#)
- (4) [File name](#)
- (5) [Format card](#)
- (6) [Auto rotate](#)
- (7) [Add \[laptop icon\] rotate info](#)

● Country/Area/Guidance/Audio settings

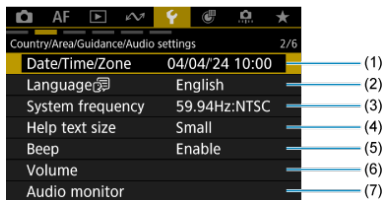

- (1) [Date/Time/Zone](#)
- (2) [Language](#)
- (3) [System frequency](#)
- (4) [Help text size](#)
- (5) [Beep](#)
- (6) [Volume](#)
- (7) [Audio monitor](#)

● Customize display

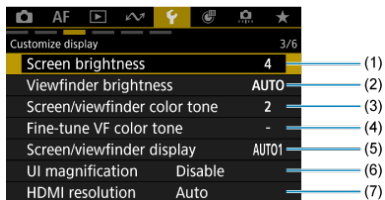

- (1) [Screen brightness](#)
- (2) [Viewfinder brightness](#)
- (3) [Screen/viewfinder color tone](#)
- (4) [Fine-tune VF color tone](#)
- (5) [Screen/viewfinder display](#)
- (6) [UI magnification](#)
- (7) [HDMI resolution](#)

● Various settings

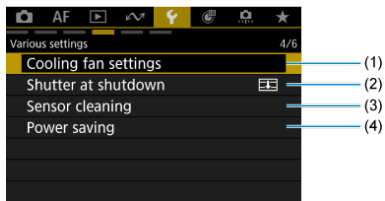

- (1) [Cooling fan settings](#)
- (2) [Shutter at shutdown](#)
- (3) [Sensor cleaning](#)
- (4) [Power saving](#)

Note

- **[Cooling fan settings]** is displayed when Cooling Fan CF-R20EP (sold separately) is attached.

● Reset/All settings

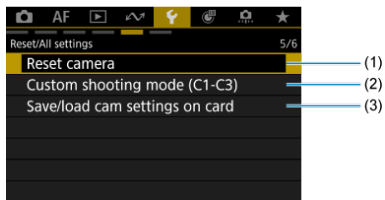

- (1) [Reset camera](#) ☆
- (2) [Custom shooting mode \(C1-C3\)](#) ☆
- (3) [Save/load cam settings on card](#) ☆

● Various settings

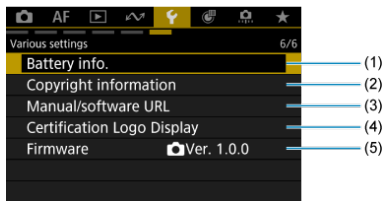

- (1) [Battery info.](#)
- (2) [Copyright information](#) ☆
- (3) [Manual/software URL](#)
- (4) [Certification Logo Display](#) ☆
- (5) [Firmware](#)

Selecting Cards for Recording/Playback



 [Recording Method with Two Cards Inserted](#)

 [Recording/Playback Selection with Two Cards Inserted](#)

Recording is possible when card [1] or [2] is in the camera (except under some conditions). With only one card inserted, there is no need to follow these steps.

With two cards inserted, you can select the recording method and card to use for recording and playback as follows.



Recording Method with Two Cards Inserted

1. Select [: Record func+card/folder sel.] ().



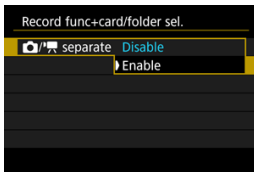

2. Set the recording method.

-   **separate**



Select [**Enable**] for automatic configuration of the recording method for still photos and movies. Movies are recorded to card  and still photos to card .

Caution

- Specifying [**Enable**] will make [ **Rec options**], [ **Rec options**], [ **Record/play**], and [ **Record/play**] unavailable.

Note

- For playback, press the <  > button for movie playback in movie recording mode or for still photo playback in still photo shooting mode.

● Rec options

Set the recording method for still photos.

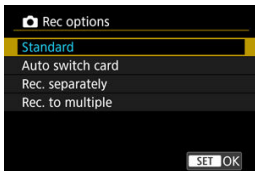



- **Standard**

Records still photos to the card selected in [ Record/play].

- **Auto switch card**



Same as [**Standard**], but additionally, the camera switches to the other card when one card becomes full. When the camera switches cards, a new folder is created.

- **Rec. separately**

Enables you to set a specific image size for each card (). For each shot, a still photo is recorded to card  and  in your specified image quality.



Note that recording separately to **RAW** and **CRAW** is not available for RAW images.

- **Rec. to multiple**

For each shot, a still photo is recorded to card  and  in the same image quality.

Consider using an SD card with fast writing speeds for card , such as a UHS-II card.

Caution

- Maximum burst for [**Rec. separately**] is lower if you specify different image sizes for cards  and  ().

Note

Rec. separately/Rec. to multiple

- Images are recorded with the same file number to card [1] and [2].
- The number of shots available as shown in the viewfinder and on the Quick Control screen is for the card with less free space.
- [Card* full] is displayed when one of the cards becomes full, and shooting is no longer possible. To continue shooting, either replace the card or set [Rec options] to [Standard] and select the card with free space.
- See [Folder Settings](#) for details on [Folder] in [F: Record func +card/folder sel.].

● Rec options

Set the recording method for movies.

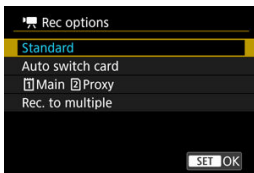

• Standard

Records movies to the card selected in [Record/play].

• Auto switch card

Same as [Standard], but shooting ends when the card becomes full. When you resume shooting, the camera switches to the other card. At this time, a new folder is created.

- **1 Main 2 Proxy**

Main movies are recorded to card 1 and proxy movies to card 2 with the same file name (but with _Proxy appended to proxy movies). You can set the file name in the [Movies] setting in [F: File name].

- **Rec. to multiple**

For each recording, the same movie is recorded to card 1 and 2. Note that movie recording is not available when card 2 is an SD/SDHC card.

! Caution

- Recording to SD cards may not be possible, depending on the movie recording size. Pressing the movie shooting button will not start recording. For details, see [Specifications](#).

Note

[1]Main [2]Proxy

- When recording stops for a main movie, recording also stops for the proxy movie.
Main movie recording continues even if proxy movie recording stops.
- Recording is possible even with only one card loaded.
- The same angle of view and frame rate is used for proxy movies as for main movies.
Recording resolution is as follows.
 - For [4K-D / 4K-D] (4096×2160) main movies: [2K-D / 2K-D] (2048×1080) proxy movies
 - For [4K-U / 4K-U] (3840×2160) main movies: [FHD / FHD] (1920×1080) proxy movies
- At frame rates of 100 fps or higher, proxy movies cannot be recorded.
- Audio quality can be set for each type of movie in [📷: Audio format].

Rec. to multiple

- Images are recorded with the same file number to card [1] and [2].
- The number of shots available as shown in the viewfinder and on the Quick Control screen is for the card with less free space.
- [Card* full] is displayed when one of the cards becomes full, and shooting is no longer possible. To continue shooting, either replace the card or set [🗨️ Rec options] to [Standard] and select the card with free space.
- See [Folder Settings](#) for details on [Folder] in [🔊: Record func +card/folder sel.].

Recording/Playback Selection with Two Cards Inserted

With [📷 Rec options]/[🎥 Rec options] set to [Standard] or [Auto switch card], select the card for recording and playback.

With [📷 Rec options] set to [Rec. separately] or [Rec. to multiple], or with [🎥 Rec options] set to [1]Main [2]Proxy or [Rec. to multiple], select the card for playback.

Setting via the menu

● Standard/Auto switch card

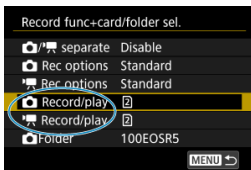

Select [Record/play].

- Select [📷 Record/play] for still photos or [🎥 Record/play] for movies.
[1]: Use card 1 for recording and playback
[2]: Use card 2 for recording and playback

● Rec. separately/Rec. to multiple/[1]Main [2]Proxy

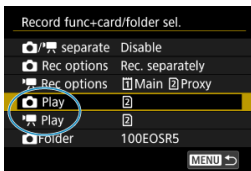

Select [Play].

- Select [📷 Play] for still photos or [🎥 Play] for movies.
- Pressing the [▶] button in still photo shooting mode plays images from the card selected in [📷 Play].
- Pressing the [▶] button in movie recording mode plays images from the card selected in [🎥 Play].



Note

- With [**Priority:**] set, the camera switches to the priority card when cards are inserted or removed.

Folder Settings

 [Creating a Folder](#)

 [Renaming Folders](#)



 [Selecting a Folder](#)

You can create or select the folder for saving still photos. You can also rename folders.

Note

- Movie files are saved in the following folder (with **** indicating the reel number).
 - XF-HEVC S or XF-AVC S movie files (.MP4): REEL_**** folder in the XFVC folder (up to 999 files)
 - RAW movie files (.CRM): REEL_**** folder in the CRM folder (up to 999 files)
- When a new card is loaded, the folder created is named with the reel number set in the [Reel Number] setting for [Movies] in [: File name]. Once the folder has been created, other folders cannot be created, and folders cannot be renamed.

Creating a Folder

1. Select [: Record func+card/folder sel.] ().
2. Select [Folder].

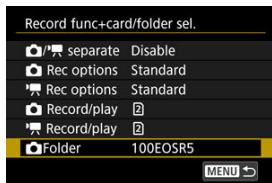

3. Select [Create folder].

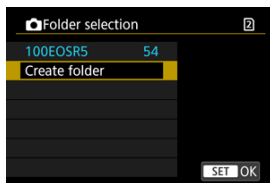

4. Select [OK].

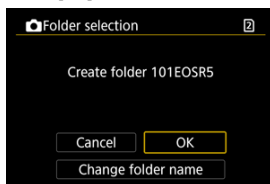

- To rename the folder, select [Change folder name].

1. Enter letters and numbers of your choice.

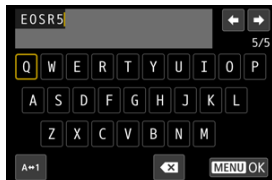

- You can enter five characters.
- By selecting [A⇌1], you can change the input mode.
- To delete single characters, select [X] or press the button.

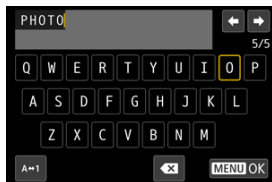

- Use the <DIAL> or <MULTISELECT> to select a character, then press <SET> to enter it.

2. Exit the setting.

- Press the <MENU> button, then press [OK].

Selecting a Folder

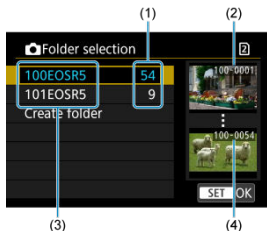

(1) Number of images in folder

(2) Lowest file number

(3) Folder name

(4) Highest file number

- Select a folder on the folder selection screen.
- Captured images are stored in your selected folder.

Note

Folders

- Folders are named as in "100EOSR5," with a three-digit folder number followed by five letters or numbers. A folder can contain up to 9999 images (file number 0001–9999). When a folder becomes full, a new folder with the folder number increased by one is created automatically. Also, if manual reset (Ⓢ) is executed, a new folder will be created automatically. Folders numbered from 100 to 999 can be created.

Creating folders with a computer

- With the card open on the screen, create a new folder with "DCIM" as the name. Open the DCIM folder and create as many folders as necessary to save and organize your images. "100ABC_D" is the required format for folder names, and the first three digits must be a folder number in the range 100–999. The last five characters can be any combination of upper- and lower-case letters from A to Z, numerals, and the underscore "_". The space cannot be used. Also note that two folder names cannot share the same three-digit folder number (for example, "100ABC_D" and "100W_XYZ") even if the remaining five characters in each name are different.

Still Photo File Numbering

[Continuous](#)

[Auto Reset](#)

[Manual Reset](#)

Captured still photos saved in a folder are assigned a file number from 0001 to 9999. You can change how the image files are numbered.

(Example)
IMG_0001.JPG
|
(1)
(1) File number

1. Select [ File numbering] ().

2. Set the item.

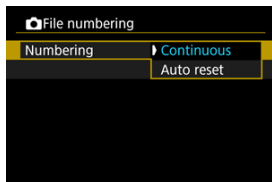

- Select [**Numbering**].
- Select [**Continuous**] or [**Auto reset**].

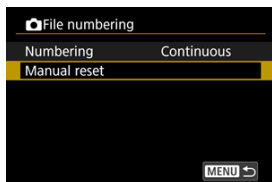

- If you want to reset the file numbering, select [**Manual reset**] (🔗).

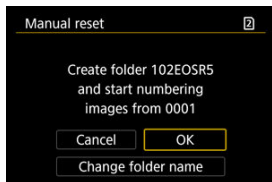

- Select [**OK**] to create a new folder, and the file number will start with 0001.

⚠ Caution

- If the file number in folder 999 reaches 9999, shooting will not be possible even if the card still has free space. After a message requesting you to replace the card is displayed, switch to a new card.

For continuous file numbering regardless of switching cards or creating folders

File numbering is continuous up to 9999, even if you replace a card, create a folder, or switch the target card (as in ①→②). This is useful when you want to save images numbered anywhere between 0001 to 9999 on multiple cards or in multiple folders into one folder on a computer.

Note that file numbering may continue from any existing images in cards or folders that you switch to. If you want to use continuous file numbering, it is recommended that you use a newly formatted card each time.

File numbering after replacing cards or switching target cards

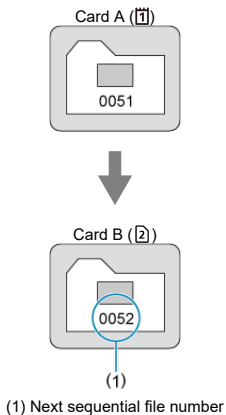

File numbering after creating a folder

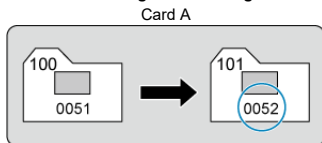

For restarting file numbering from 0001 after switching cards or creating folders

File numbering is reset to 0001 if you replace a card, create a folder, or switch the target card (as in **1**→**2**). This is useful if you want to organize images by cards or folders. Note that file numbering may continue from any existing images in cards or folders that you switch to. If you want to save images with the file numbering starting from 0001, use a newly formatted card each time.

File numbering after replacing cards or switching target cards

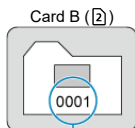
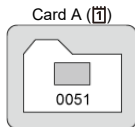

(1)

(1) File numbering is reset

File numbering after creating a folder

Card A

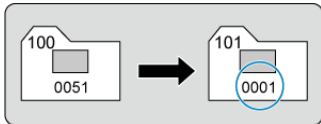

For resetting file numbering to 0001 or starting from 0001 in new folders

When you reset the file numbering manually, a new folder is created automatically and the file numbering of images saved to that folder starts from 0001.

This is useful, for example, if you want to use different folders for the images taken yesterday and the ones taken today.

Movie Clip Numbering

[Continuous](#)

[Auto Reset](#)

Recorded movies saved in a folder are assigned a clip number from 001 to 999. You can change how clips are numbered.

(Example)
A_0001**C001**Ayymdd_hhmmssXX_CANON_Proxy
 ↓
 (1)

(1) Clip number

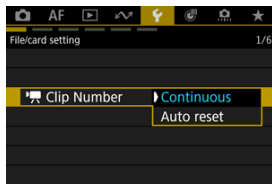

1. Select [:  Clip Number] ().

2. Set the item.



- Select [**Continuous**] or [**Auto reset**].

Note

- The XFVC and CRM folder each hold up to 999 files. You can check the number of movie files by referring to [: **Set image search conditions**] (). If a card already has 999 files, either delete existing movies or use a different card.

For continuous file numbering regardless of switching cards

Clip numbering is continuous up to 999, even if you replace a card or switch the target card (as in ①→②). This is useful when movies numbered between 001 to 999 on multiple cards will be saved in a single folder on a computer, for example.

Note that numbering may continue after the number of any existing movies on cards that you switch to. If you prefer continuous movie numbering, consider using a newly formatted card each time.

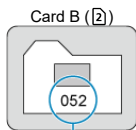
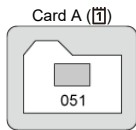

(1)

(1) Next sequential clip number

For restarting clip numbering from 001 after switching cards

Clip numbering is reset to 001 if you replace a card or switch the target card (as in **1**→**2**). This is useful if you want to organize movies by cards.

Note that numbering may continue after the number of any existing movies on cards that you switch to. If you want to save images with the file numbering starting from 001, use a newly formatted card each time.

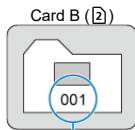
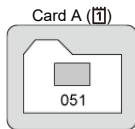

(1)

(1) Clip numbering is reset

File Naming

[☑ Registering/Changing Still Photo File Names](#)

[☑ Movie File Name Settings](#)

Registering/Changing Still Photo File Names

File names consist of four alphanumeric characters followed by a four-digit file number (☑) and file extension. You can change the first four alphanumeric characters, which by default are unique for each camera and set when the camera is shipped.

User setting 1 enables you to register four characters of your choice. User setting 2 adds three initial, registered characters of your choice to a fourth character representing the image size that is added automatically after you shoot.

(Example)
IMG_0001.JPG

1. Select [**F**: File name] (☑).
2. Select [Stills].

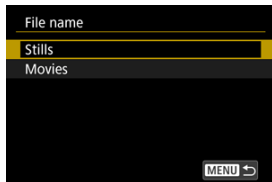

3. Select [Change User setting*].

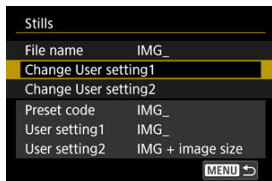

4. Enter letters and numbers of your choice.

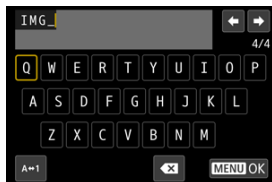

- Enter four characters for User setting 1 or three for User setting 2.
- By selecting [**A⇌1**], you can change the input mode.
- To delete single characters, select [**X**] or press the \leftarrow button.



- Use the \odot or \odot dial or \odot to select a character, then press \odot to enter it.

5. Exit the setting.

- Press the **<MENU>** button, then press **[OK]**.

6. Select a registered file name.

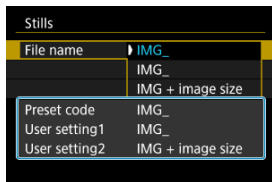

- Select [**File name**], then choose a registered file name.

⚠ Caution

- An underscore (“_”) cannot be used as the first character.

📄 Note

Notes on [User setting2]

- Shooting after you have selected “**** + image size” (as registered to User setting 2) will add a character representing the current image size to your file name as the fourth character. Meanings of added characters are as follows.

“***L” : L, L, RAW, or HEIF

“***M” : M or M

“***S” : S1 or S1

“***T” : S2

“***C” : CRAW

The automatically added fourth character enables you to determine image sizes without opening the files after transferring them to a computer. Based on file extensions, you can also distinguish RAW, JPEG, and HEIF images.

Movie File Name Settings

You can set how movie files (clips) are named.

Movie file name structure

(Example)

A_0001C001Aymmdd_hhmmssXX_CANON_Proxy

(1) (2) (3) (4) (5) (6) (7) (8) (9)

	Item	Description
(1)	Camera index	Two letters in the range A–Z. An underscore (_) can also be used as the second character. Identifies the camera used.
(2)	Reel number	A 4-digit number from 0001 to 9999. A different number is automatically assigned to identify the card used. You can set the default value. Advances by one when the first recording on a new card* is made. * Newly purchased or formatted card
(3)	Clip number	A 3-digit number from 001 to 999 preceded by C, as in C001–C999. After C999, D is used at the beginning. Automatically assigned to each clip (movie file). You can set the default value.
(4)	Codec identifier	"A" (as in AVC) is automatically set for H.264 main movies, "H" for HEVC, and "X" for RAW.
(5)	Recording date	Year, month, and day, set automatically based on when recording began.
(6)	Recording time	Hour, minute, and second, set automatically based on when recording began.
(7)	Random component	Two characters, from A to Z and 0 to 9, randomly set for each clip (movie file).
(8)	User-defined field	Five characters, from A to Z and 0 to 9. Default: CANON.
(9)	Proxy identifier	_Proxy is automatically appended to proxy movie files.

- File names for main and proxy movies is identical except for _Proxy, as described in (9).
- File names assigned for **[Rec. to multiple]** are the same for files on both cards.

Configuring movie file names

1. Select [**F**: File name] ()
2. Select [**Movies**].

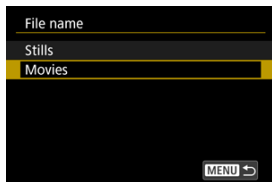

3. Configure movie file name settings.

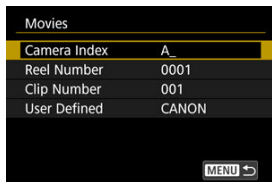

- **Camera index**

Enter two characters of your choice.

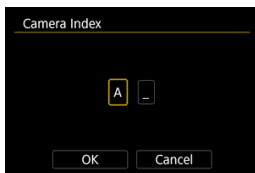

- Set defaults for [**Reel Number**] and [**Clip Number**] as needed.



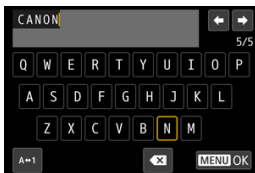

- **User defined**

Enter letters or numbers of your choice.



- You can enter five characters.
- By selecting [**A↔1**], you can change the input mode.
- To delete single characters, select [**X**] or press the <  > button.





- Use the <  > or <  > dial or <  > to select a character, then press <  > to enter it.

Card Formatting

If the card is new or was previously formatted (initialized) by another camera or computer, format the card with this camera.

⚠ Caution

- When the card is formatted, all images and data on the card will be erased. Even protected images will be erased, so make sure there is nothing you need to keep. If necessary, transfer the images and data to a computer, etc. before formatting the card.

1. Select [: Format card] ()
2. Select a card.



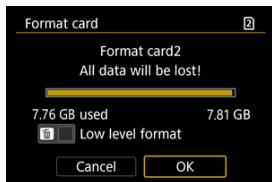

- [] represents card 1, and [], card 2.

3. Format the card.

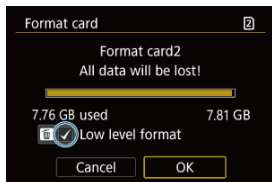

- Select [OK].



- For low-level formatting, press the  button to add a checkmark  to [Low level format], then select [OK].

Conditions requiring card formatting

- The card is new.
- The card was formatted by a different camera or a computer.
- The card is full of images or data.
- A card-related error is displayed ().

Low-level formatting

- Perform low-level formatting if the card's writing or reading speed seems slow or if you want to totally erase the data on the card.
- Since low-level formatting will format all recordable sectors on the card, the formatting will take longer than normal formatting.
- During low-level formatting, you can cancel formatting by selecting **[Cancel]**. Even in this case, normal formatting will already be complete and you can use the card as usual.

Card file formats

- CFexpress cards are exFAT formatted.
- SD cards are FAT16 or FAT12 formatted.
- SDHC cards are FAT32 formatted.
- SHXC cards are exFAT formatted.
- Individual movies recorded to exFAT-formatted cards are recorded as a single file (without splitting them into multiple files) even if they exceed 4 GB, so the resulting movie file will exceed 4 GB.

Caution

- It may not be possible to use cards formatted with this camera in other cameras. Also note that exFAT-formatted cards may not be recognized by some computer operating systems or card readers.
- Formatting or erasing data on a card does not completely erase the data. Be aware of this when selling or discarding the card. When disposing of cards, take steps to protect personal information if necessary, as by physically destroying cards.

Note

- The card capacity displayed on the card format screen may be smaller than the capacity indicated on the card.
- This device incorporates exFAT technology licensed from Microsoft.

Auto Rotate

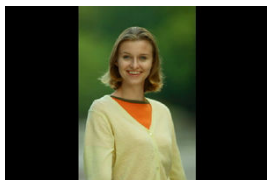



You can change the auto rotation setting that straightens images shot in vertical orientation when they are displayed.

1. Select [: Auto rotate] ()

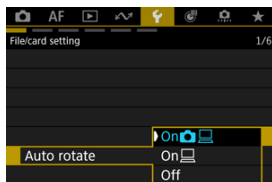
2. Select an option.



- **On** 
Automatically rotates images for display on both the camera and computers.
- **On** 
Automatically rotates images only for display on computers.
- **Off**
Images are not automatically rotated.

 **Caution**

- Images captured with auto rotation set to **[Off]** will not rotate during playback even if you later set auto rotation to **[On]**.

 **Note**

- If a picture is taken while the camera is aimed up or down, automatic rotation to the proper orientation for viewing may not be performed correctly.
- If images are not rotated automatically on a computer, try using EOS software.

Adding Orientation Information to Movies

For movies recorded with the camera held vertically, orientation information indicating which side is up can be added automatically to enable playback in the same orientation on smartphones or other devices.

1. Select [**📷**: Add **📱** rotate info] (**Ⓜ**).

2. Select an option.

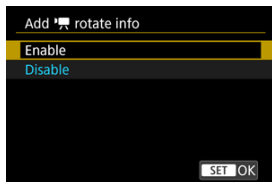

- **Enable**
Play movies on smartphones or other devices in the orientation in which they were recorded.
- **Disable**
Play movies horizontally on smartphones or other devices, regardless of the recording orientation.

! Caution

- Movies are played horizontally on the camera and via HDMI video output, regardless of this setting.
- Orientation information is not added to main and proxy movies when [**📷**: **Main rec. format**] is set to [**RAW**].

Date/Time/Zone

When you turn on the power for the first time or if the date/time/zone have been reset, follow these steps to set the time zone first.

By setting the time zone first, you can simply adjust this setting as needed in the future and the date/time will be updated to match it.

Since the captured images will be appended with the shooting date and time information, be sure to set your date/time.

1. Select [**📅**: Date/Time/Zone] (**🔗**).
2. Set the time zone.

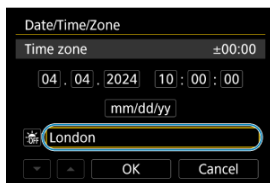

- Turn the <  > dial to select [Time zone].

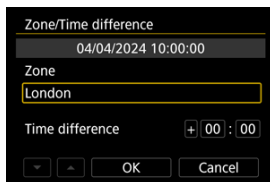

- Press <  >.

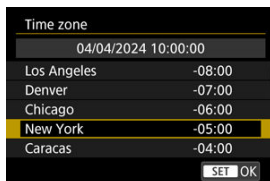

- Turn the < ⌚ > dial to select the time zone, then press < SET >.
- If your time zone is not listed, press the < MENU > button, then set the difference from UTC in [Time difference].

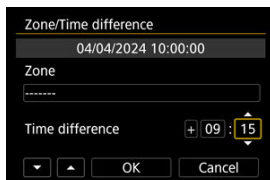

- Turn the < ⌚ > dial to select a [Time difference] option (+ / - / hour / minute), then press < SET >.
- Set by turning the < ⌚ > dial, then press < SET >.
- After entering the time zone or time difference, turn the < ⌚ > dial to select [OK], then press < SET >.

3. Set the date and time.

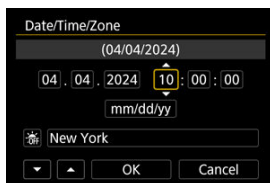

- Turn the < ⌚ > dial to select an option, then press < SET >.
- Set by turning the < ⌚ > dial, then press < SET >.

4. Set daylight saving time.

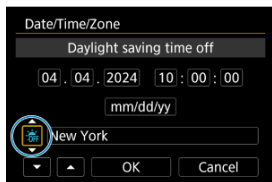

- Set it as necessary.
- Turn the < > dial to select [], then press < >.
- Turn the < > dial to select [], then press < >.
- When the daylight saving time is set to [], the time set in step 3 will advance by 1 hour. If [] is set, the daylight saving time will be canceled and the time will go back by 1 hour.

5. Exit the setting.

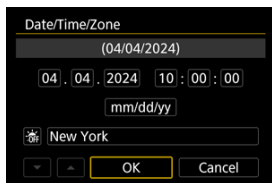

- Turn the < > dial to select [**OK**].

Caution



- The date, time, and time zone settings may be reset when the camera is stored without the battery, when the battery is exhausted, or when it is exposed to freezing temperatures for an extended period. If this happens, set them once again.
- After changing [**Zone/Time difference**], check that the correct date/time are set.



Note

- Auto power off time may be extended while the [👉: **Date/Time/Zone**] screen is displayed.



Language

1. Select [: Language ] ().
2. Set the desired language.



System Frequency

Set the video system of any television used for display. This setting determines the frame rates available when you record movies.

1. Select [: System frequency] ().
2. Select an option.

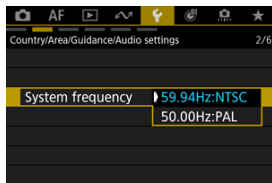

- **59.94Hz:NTSC**
For areas where the TV system is NTSC (North America, Japan, South Korea, Mexico, etc.).
- **50.00Hz:PAL**
For areas where the TV system is PAL (Europe, Russia, China, Australia, etc.).

Help

[Changing the Help Text Size](#)

When **[INFO Help]** is displayed, you can display a description of the feature by pressing the **< INFO >** button. Press it again to exit Help display. To scroll the screen when a scrollbar (1) appears on the right, turn the **< ○ >** dial.

● Example: [Case Auto character.]

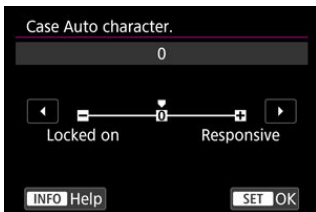

< INFO >

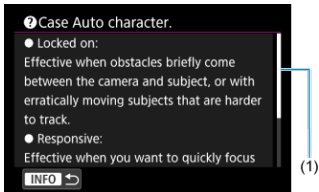



● Example: [Multi function lock]

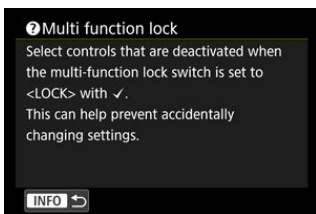

<INFO>



Changing the Help Text Size

1. Select [: Help text size] ().
2. Select an option.

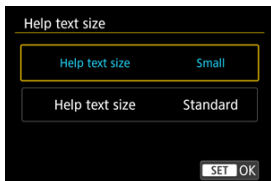

Beeps

1. Select [: Beep] ().

2. Select an option.

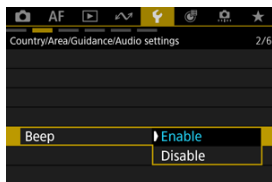

- **Enable**
The camera beeps after focusing and in response to touch operations.
- **Disable**
Disables beeping for focusing, self-timer, shutter, and touch operations.

Note

- By default, beeping volume for touch operations is set to [0] ().

Volume

The volume of camera sounds is adjustable.

1. Select [**🔊**: Volume] (🔊).

2. Select an option.

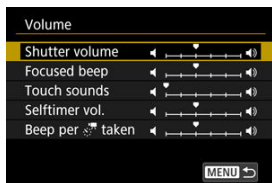

3. Adjust the volume.



- Turn the <🌀> dial to adjust the volume, then press <🔊>.

Note

- The camera always beeps, regardless of [**📷**: Shutter mode] settings, with [**Always play at release**] selected in [**Shutter volume**] settings.

Audio Monitor

[Headphones](#)

[HDMI](#)

Headphones

Adjusting the volume

1. Select [**🔊**: Audio monitor] ().
2. Select [Headphones].

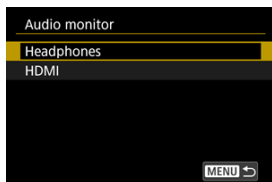

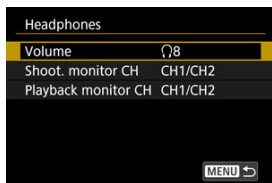

3. Select [Volume].



4. Adjust the volume.





- Turn the <  > dial to adjust the volume, then press <  >.

Note

- You can use headphones to check sound from the built-in microphone or an external microphone when [: **Sound recording**] is set to [**On**] and [**High Frame Rate**] is set to [**Disable**].

Selecting output channels for the headphone terminal

You can select the combination of channels for output from the headphone terminal during shooting or playback. This setting also applies to speaker output ().

1. Select [: **Audio monitor**] ().
2. Select [**Headphones**].

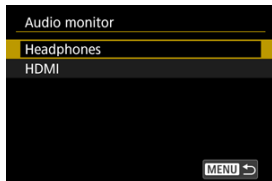

3. Select [Shoot. monitor CH] or [Playback monitor CH].

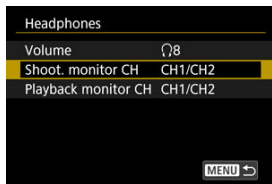

4. Select the combination of channels for audio output (L/R).

Shoot. monitor CH

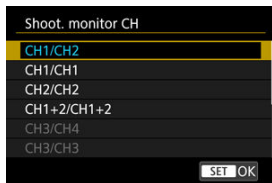

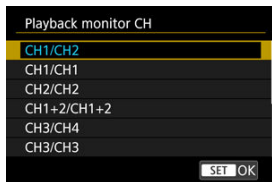

Playback monitor CH





- CH1+2 indicates that the signal is a combination of channels 1 and 2. The same applies to CH1+3, CH3+4, and so on.

 Caution

- There is no sound from channels 3 and 4 for [Playback monitor CH] when you shoot with : Audio format  set to [AAC/16bit/2CH], because no sound is recorded for channels 3 and 4.



Note

- The audio recording level indicator  on the movie recording screen shows channels selected in **[Shoot. monitor CH]**.
- Items that include channels 3 or 4 are not available in **[Shoot. monitor CH]** with : **Audio format**  set to **[AAC/16bit/2CH]**.

Selecting output channels for the HDMI output terminal

You can select the combination of channels for output from the HDMI output terminal during shooting or playback.

1. Select [**🔊: Audio monitor**] (**☑**).

2. Select [**HDMI**].

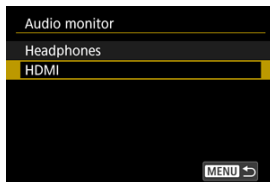

3. Select [**Shoot. monitor CH**] or [**Playback monitor CH**].

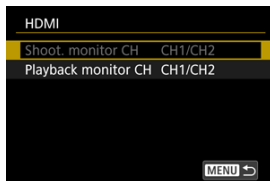

4. Select [CH1/CH2] or [CH3/CH4].

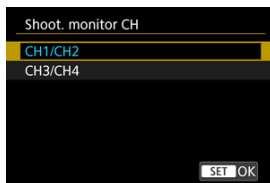

Shoot. monitor CH



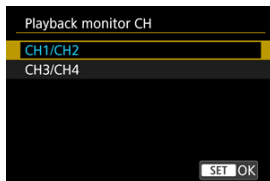

Playback monitor CH





 Caution

- No sound is produced when you play a movie recording with [: **Audio format**] () set to **[AAC/16bit/2CH]** and [**Playback monitor CH**] set to **[CH3/CH4]**.

Screen Brightness

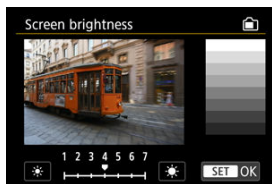
1. Select [: Screen brightness] ().
2. Make the adjustment.





- Referring to the gray image, turn the < > dial to adjust brightness, then press < >. Check the effect on the screen.

Note

- To check the image's exposure, referring to the histogram is recommended ().

Viewfinder Brightness

1. Select [: Viewfinder brightness] ().
2. Turn the  dial and select either [Auto] or [Manual].



Auto



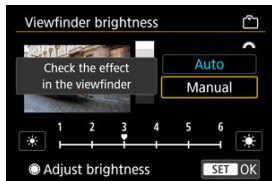

- Press . Check the effect in the viewfinder while shooting.

Manual



- Turn the  dial to adjust viewfinder brightness, then press . Check the effect in the viewfinder.

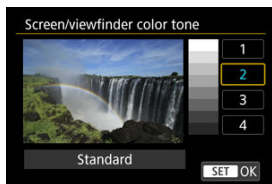

Screen and Viewfinder Color Tone

1. Select [: Screen/viewfinder color tone] ().
2. Make the adjustment.





- Turn the <  > dial to select an option, then press <  >.

Fine-Tuning Viewfinder Color Tone

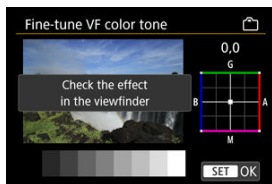
1. Select [: Fine-tune VF color tone] ().
2. Make the adjustment.



- Referring to the gray image, use < > for adjustment, then press < >. Check the effect in the viewfinder.

Screen and Viewfinder Display

You can specify to use the screen or viewfinder for display, to avoid accidentally activating the viewfinder sensor when the screen is open.

1. Select [: Screen/viewfinder display] ().
2. Select an option.

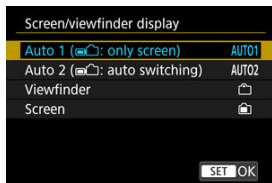



- **AUTO1: Auto 1 (): only screen**
Always use the screen for display when it is open.
Use the screen for display when it is closed and facing you, and switch to the viewfinder when you look through it.
- **AUTO2: Auto 2 (): auto switching**
Use the screen for display when it is closed and facing you, and switch to viewfinder display when you look through the viewfinder.
- : **Viewfinder**
Always use the viewfinder for display.
- : **Screen**
Always use the screen for display when it is open.

Note

- You can also switch between viewfinder and screen display by pressing a button you have customized by assigning to switching. With this setting set to **[AUTO1]** or **[AUTO2]**, the camera responds to the viewfinder sensor accordingly.
- With **[AUTO1]** set, the camera does not respond to the viewfinder sensor when the screen is open.

UI Magnification

You can magnify menu screens by double-tapping with two fingers. Double-tap again to restore the original display size.

1. Select [: UI magnification] ()
2. Select [Enable].

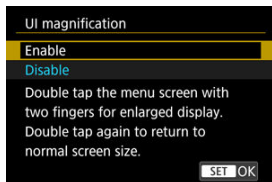



Caution

- Use camera controls when configuring menu functions with the display magnified. Touch-screen operations are not supported.

HDMI Resolution

Set the image output resolution used when the camera is connected to a television or external recording device with an HDMI cable.

1. Select [: HDMI resolution] ()
2. Select an option.

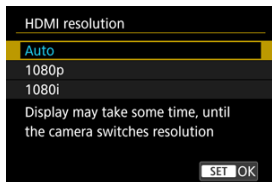

- **Auto**
The images will automatically be displayed at the optimum resolution matching the connected television.
- **1080p**
Output at 1080p resolution. Select if you prefer to avoid display or delay issues when the camera switches resolution.
- **1080i**
Output at 1080i resolution. Select if you prefer to avoid display or delay issues when the camera switches resolution.

Note

- If the card contains a mix of movies recorded with different settings, it may take some time before images are displayed.



Cooling Fan Settings

[Fan](#)

[Fan Rotation Speed](#)

Cooling fan settings can be configured from the camera when an optional cooling fan is used. Attach the cooling fan before configuring the settings () .

Fan

1. Select [: Cooling fan settings] ().
2. Select [Fan].

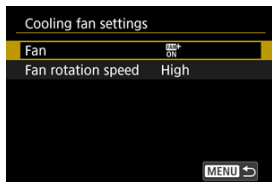

3. Select an option.

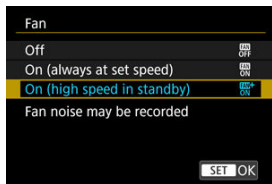

- **Off**
Keeps the fan off.
- **On (always at set speed)**
The fan remains on at the speed set in **[Fan rotation speed]**.
- **On (high speed in standby)**
The fan remains on at high speed both in standby and when the camera is not recording movies or sound. During sound recording, the fan remains on at the speed set in **[Fan rotation speed]**.

Caution

- Warm air is discharged from the exhaust vent while the cooling fan is on.
- Under these conditions, the fan remains on at high speed even when set to **[On (high speed in standby)]**.
 - When recording High Frame Rate movies
 - When recording time-lapse movies
 - When only recording to external devices connected via HDMI

Fan Rotation Speed

1. Select [Fan rotation speed].

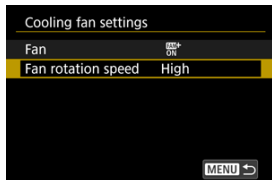

2. Set the fan level.

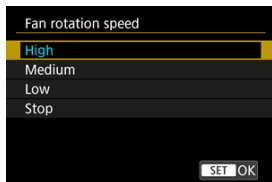

Note

- Setting [Fan] to [On (always at set speed)] with [Fan rotation speed] set to [Stop] will automatically switch [Fan rotation speed] to [Low].

Shutter at Shutdown

You can set whether to leave the shutter open or close it when the camera's power switch is set to **<OFF>**.

1. Select [**⚙**: Shutter at shutdown] (**Ⓜ**).
2. Select an option.

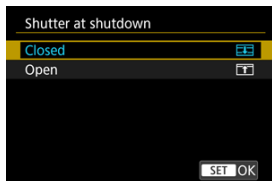

- **Ⓜ**: **Closed**
Closes the shutter. Normally set to closed, to prevent dust from adhering to the sensor when you switch lenses.
- **Ⓜ**: **Open**
Leaves the shutter open. This keeps camera quieter when the power switch is set to **<ON>** or **<OFF>**. Useful when you want to shoot quietly.

Ⓜ Note

- Regardless of the setting, the shutter remains as it is when auto power off is activated.

Sensor Cleaning

[Cleaning Now](#)

[Cleaning Automatically](#)

[Cleaning Manually](#)

The camera's sensor cleaning feature cleans the front of the image sensor.

Note

- For best results, clean with the camera in a stable position on a desk or other flat surface.

Cleaning Now

1. Select [**☑**: Sensor cleaning] ()
2. Select [Clean now, ].

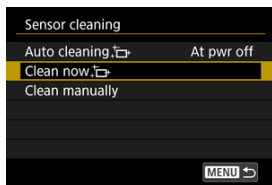

- Select [OK] on the confirmation screen.

Note

- Even if you repeat the sensor cleaning, the result will not improve much. Note that [Clean now, ] may not be available immediately after cleaning.

1. Select [Auto cleaning, ].

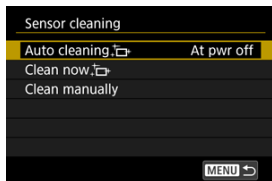

2. Select an option.

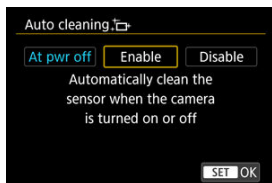

- Turn the <  > dial to select an option, then press <  >.

Note

- When set to [At pwr off] or [Enable], the sensor is cleaned when the screen goes off, including when it has been turned off automatically.

Cleaning Manually

Dust that could not be removed by automatic cleaning can be removed manually with a commercially available blower or similar tool.

Always use a fully charged battery.

The image sensor is extremely delicate. If the sensor needs to be cleaned directly, having it done by a Canon Service Center is recommended.

1. Select [Clean manually].

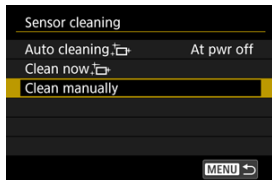

2. Select [OK].

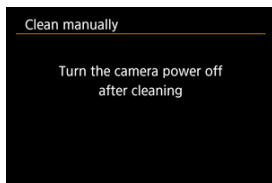
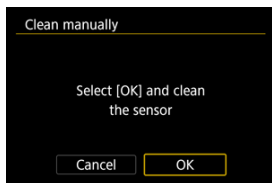

3. Remove the lens and clean the sensor.

4. End the cleaning.

- Set the power switch to < OFF >.



Note

- Using the household power outlet accessories (sold separately) is recommended.





Caution

- **While cleaning the sensor, never do any of the following. If the power is cut off, the shutter will close. These may result in damaging the image sensor and shutter curtains.**
 - **Setting the power switch to < OFF >.**
 - **Removing or inserting the battery.**
- The surface of the image sensor is extremely delicate. Clean the sensor with care.
- Use a plain blower without any brush attached. A brush can scratch the sensor.
- Do not insert the blower tip inside the camera beyond the lens mount. If the power is turned off, the shutter will close and the shutter curtains may get damaged.
- Never use pressurized air or gas to clean the sensor. Pressurized air may damage the sensor, and sprayed gas may freeze on the sensor and scratch it.
- If the battery level becomes low while cleaning the sensor, the beeper will sound as a warning. Stop cleaning the sensor.
- If a smudge that cannot be removed with a blower remains, having the sensor cleaned by a Canon Service Center is recommended.

Power Saving

You can adjust the timing of when the screen dims and then turns off, when the camera turns off, and when the viewfinder turns off after the camera is left idle (Screen dimmer, Screen off, Auto power off, and Viewfinder off).

1. Select [: Power saving] (.
2. Select an option.

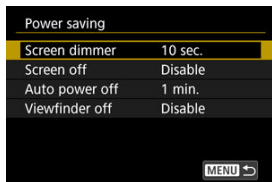

Note

- **[Screen dimmer]** and **[Screen off]** apply while the shooting screen is displayed. These settings do not apply during menu display or image playback.
- The camera turns off during menu display or image playback after the time set in **[Screen dimmer]**, **[Screen off]**, and **[Auto power off]** elapses.
- To protect the screen, the screen turns off 30 min. after it is dimmed (although the camera itself remains on), even if **[Screen off]** and **[Auto power off]** are set to **[Disable]**.
- **[Viewfinder off]** also applies while the screen is still on. After this time elapses, the viewfinder sensor is deactivated.
- Only **[Viewfinder off]** applies during viewfinder display. After this time elapses, the viewfinder sensor is deactivated and the viewfinder turns off.
- Images on the screen are displayed at a lower frame rate after the screen dims during still photo shooting standby.
- Auto power off does not take effect during USB connections, whether to Camera Connect or other apps or devices.

The camera's settings for shooting functions and menu functions can be restored to their defaults.

1. Select [**⚙**: Reset camera] (ⓘ).
2. Select an option.

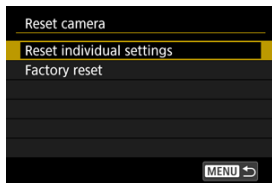

- **Reset individual settings**
Settings for individual selected options can be reset.
 - **Factory reset**
Resets all settings to defaults.
3. Clear the settings.
 - Select [**OK**] on the confirmation screen.

Note

- Still photo Custom shooting modes are reset when [**Custom shooting mode (C1-C3)**] in [**Reset individual settings**] is selected in still photo shooting mode, and movie Custom shooting modes are reset when this option is selected in movie recording mode.

[Automatic Update of Registered Settings](#)

[Canceling Registered Custom Shooting Modes](#)

You can register current camera settings such as shooting, menu, and Custom Function settings as Custom shooting modes assigned to [C1] to [C3] modes. You can register different functions to use when shooting still photos or movies.

1. Select [**F**: Custom shooting mode (C1-C3)] ()

2. Select [Register settings].

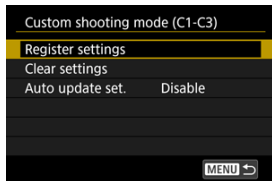

3. Register the desired items.

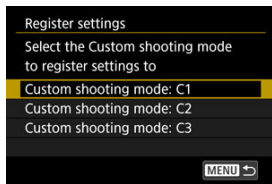

- Select the Custom shooting mode to register, then select **[OK]** on the **[Register settings]** screen.
- The current camera settings are registered to Custom shooting mode C*.
- In still photo shooting, the registered shooting mode is indicated in the Custom shooting mode icon (as in **[C1_{TV}]**, **[C2_{Av}]**, **[C3_M]**).
- Custom shooting mode icons change to **[P_{AV}]**, **[P_M]**, and **[P_{TV}]** for movie recording.
- Depending on the menu items, setting options changed in other shooting modes may not be carried over to the Custom shooting mode settings.

Automatic Update of Registered Settings

If you change a setting while shooting in Custom shooting mode, the mode can be automatically updated with the new setting (Auto update). To enable this automatic update, set **[Auto update set.]** to **[Enable]** in step 2.

Canceling Registered Custom Shooting Modes

If you select **[Clear settings]** in step 2, the settings of each mode can be restored to default settings, as they were before registration.



Note

- You can also change shooting and menu settings in Custom shooting modes.

[Saving Camera Settings](#)

[Loading Camera Settings](#)

Current camera settings such as shooting, menu, and Custom Function settings can be saved to a card as a camera settings file. By loading a camera settings file, you can apply the state of the settings as saved. This enables you to save optimal settings for particular scenes or subjects, or load settings files on other EOS R5 Mark II cameras to use the cameras with the same settings.

Saving Camera Settings

1. Select [**F**: Save/load cam settings on card] (☑).
2. Select [Save to card].

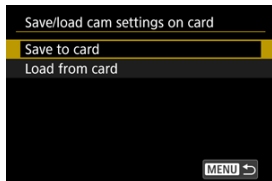

3. Select [OK].

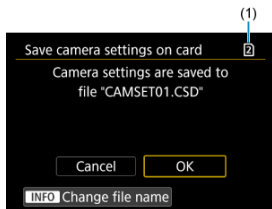

(1) Target card

- The camera settings are saved to the card.

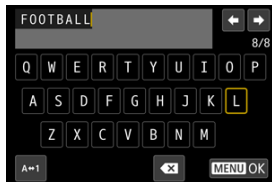

- To rename the file to an 8-character name of your choice before saving it, press the <INFO> button on the screen in step 3.
- For instructions, see [File Naming](#). The steps are the same.

Caution

- Camera settings files saved by a camera other than an EOS R5 Mark II cannot be loaded on this camera.
- It may not be possible to load camera settings files that were saved by a camera with a different firmware version.

Note

- Up to ten camera settings files can be saved on a card. If a card already has ten camera settings files, either overwrite existing files or use a different card.

Loading Camera Settings

In step 2 of [Saving Camera Settings](#), select [**Load from card**] to display up to ten camera settings files on the card. Select a file, and the camera will load it and apply the state of the settings as saved.

Battery Information

- [Registering Batteries to the Camera](#)
- [Labeling Batteries with Serial Numbers](#)
- [Checking the Remaining Capacity of a Registered Battery Not in Use](#)
- [Deleting the Registered Battery Information](#)

You can check the conditions of the battery you are using. By registering multiple batteries to the camera, you can check their approximate remaining capacity and usage history.

1. Select [**B**: Battery info.] (ⓘ).

2. Check the battery information.

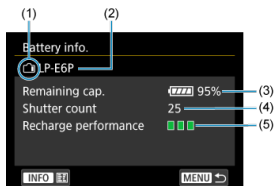

(1) Battery position

(2) Model of battery or household power source used.

(3) Battery level indicator (ⓘ) with the remaining battery level, in 1% increments.

(4) The number of shots taken with the current battery. The number is reset when the battery is charged.

(5) State of battery recharge performance, in three levels.

■ ■ ■ (Green): Battery recharge performance is good.

■ ■ □ (Green): Battery recharge performance is slightly degraded.

■ □ □ (Red): Purchasing a new battery is recommended.

 **Caution**

- Using a genuine Canon Battery Pack LP-E6P is recommended. Use of non-genuine batteries may prevent the camera from operating at full performance and may lead to malfunction.
- Remaining capacity display in 1% increments is not shown with Battery Pack LP-E6NH/LP-E6N or Battery Grip BG-R10 attached. Moreover, these batteries cannot be registered.

 **Note**

- The shutter count is the number of still photos taken (not including movie recording).
- Battery information is also displayed when optional battery grips or cooling fans are used.
- If a battery communication error message is displayed, follow the instructions in the message.

Registering Batteries to the Camera

You can register up to six LP-E6P battery packs to the camera. To register multiple batteries to the camera, follow the procedure below for each battery.

1. Press the <INFO> button.

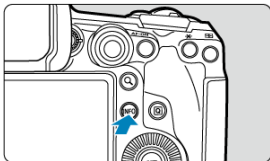

- With the battery info. screen displayed, press the <INFO> button.
- If the battery is not registered, it will be grayed out.

2. Select [Register].

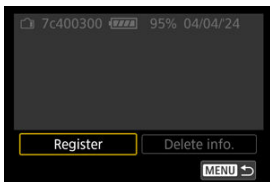

3. Select [OK].

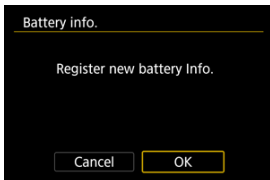

- The battery is now displayed in white.

Labeling Batteries with Serial Numbers

It is convenient to label registered LP-E6P battery packs with their serial numbers, using commercially available labels.

1. On a label approx. 25×15 mm, write the serial number (1).

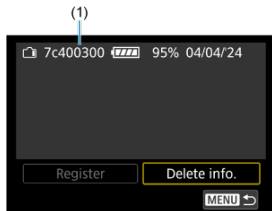

2. Apply the label.

- Set the power switch to < OFF >.
- Remove the battery from the camera.
- Apply the label as shown in the illustration (on the side with no electrical contacts).

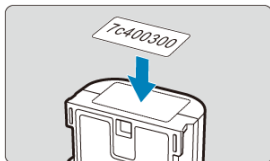

 **Caution**

- Do not apply the label on any part other than as shown in the illustration in step 2. Otherwise, the misplaced label may make it difficult to insert the battery or impossible to turn on the power.
- The label may peel off after repeated insertion and removal from the battery magazine if an optional Battery Grip BG-R20/BG-R20EP is used. If it peels off, apply a new label.

Checking the Remaining Capacity of a Registered Battery Not in Use

You can check the remaining capacity of batteries not currently in use, as well as their last date of use.

1. Find the matching serial number.

- On the battery history screen, find the battery serial number (1) matching the serial number that the battery is labeled with.
- You can check the respective battery's approximate remaining capacity (2) and the date when it was last used (3).

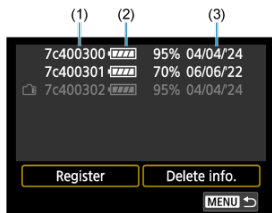

Deleting the Registered Battery Information

1. Select [Delete info.].

- In [Registering Batteries to the Camera](#), select **[Delete info.]** in step 2.

2. Select the battery information to delete, then press <  >.

- [✓] is displayed.

3. Press the <  > button.

- Select **[OK]** on the confirmation screen.

[☑ Checking the Copyright Information](#)

[☑ Deleting the Copyright Information](#)

When you set the copyright information, it will be recorded to the image as Exif information.

⚠ Caution

- If the entry for "Author" or "Copyright" is long, it may not be displayed entirely when you select **[Display copyright info.]**.

📄 Note

- You can also set or check copyright information with EOS Utility (EOS software, [🔗](#)).





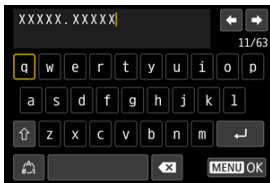

1. Select **[👤: Copyright information] [🔗](#)**.

2. Select an option.



3. Enter text.



- Use the <  > or <  > dial or <  > to select a character, then press <  > to enter it.
- By selecting [], you can change the input mode.
- To delete single characters, select [] or press the <  > button.

4. Exit the setting.

- Press the < MENU > button, then press [OK].

Checking the Copyright Information

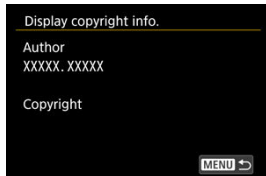

When you select [**Display copyright info.**] in step 2, you can check the [**Author**] and [**Copyright**] information that you entered.

Deleting the Copyright Information



When you select **[Delete copyright information]** in step 2, you can delete the **[Author]** and **[Copyright]** information.

Other Information

- **Manual/software URL**

To download instruction manuals, select [: **Manual/software URL**] () and scan the displayed QR code with a smartphone. You can also use a computer to access the website at the URL displayed and download software.

- **Certification Logo Display** ☆

Select [: **Certification Logo Display**] () to display some of the logos of the camera's certifications. Other certification logos can be found on the camera body and packaging.

- **Firmware**

Used to update the firmware of the camera, lens, or other compatible accessories in use. You can also update the camera firmware from Camera Connect ()

Control Customization

You can assign frequently used functions to camera buttons or dials according to your preferences for easy operations.

- [Tab Menu: Control Customization](#)
- [Control Customization Details](#)

Tab Menus: Control Customization

● Customized controls when shooting (still photo shooting)

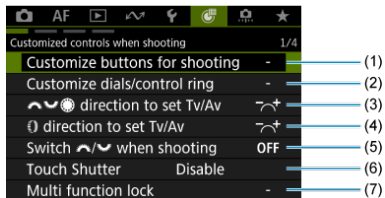

- (1) [Customize buttons for shooting](#) ☆
- (2) [Customize dials/control ring](#) ☆
- (3) [☀️ direction to set Tv/Av](#) ☆
- (4) [🕒 direction to set Tv/Av](#) ☆
- (5) [☀️/🕒 when shooting](#) ☆
- (6) [Touch Shutter](#)
- (7) [Multi function lock](#)

● Customized controls when shooting (movie recording)

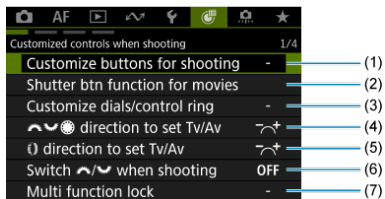

- (1) [Customize buttons for shooting](#) ☆
- (2) [Shutter btn function for movies](#)
- (3) [Customize dials/control ring](#) ☆
- (4) [☀️ direction to set Tv/Av](#) ☆
- (5) [🕒 direction to set Tv/Av](#) ☆
- (6) [☀️/🕒 when shooting](#) ☆
- (7) [Multi function lock](#)

● Customized controls when shooting

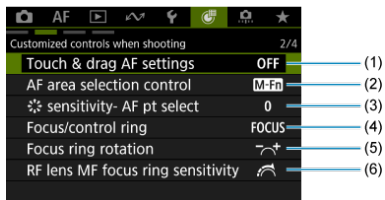

- (1) [Touch & drag AF settings](#)
- (2) [AF area selection control](#) ☆
- (3) [sensitivity- AF pt select](#)
- (4) [Focus/control ring](#) ☆
- (5) [Focus ring rotation](#)
- (6) [RF lens MF focus ring sensitivity](#)

● Customized controls when playback

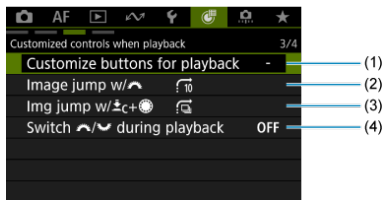

- (1) [Customize buttons for playback](#) ☆
- (2) [Image jump w/](#) 
- (3) [Img jump w/](#) 
- (4) [Switch !\[\]\(c5f009707b314589d498a683120545c5_img.jpg\) !\[\]\(8b308e9f1e6682fd04ddef01495a93be_img.jpg\) during playback](#)

● Customized controls/Reset

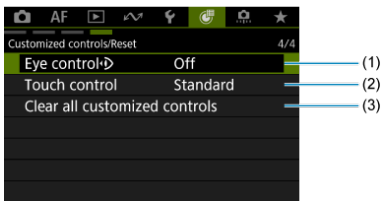

- (1) [Eye control](#)
- (2) [Touch control](#)
- (3) [Clear all customized controls](#)

Control Customization Details

[✔ \[Customized controls when shooting\]](#)

[✔ \[Customized controls when playback\]](#)



[✔ \[Customized controls/Reset\]](#)

You can customize camera features on the  tab to suit your shooting preferences.



[Customized controls when shooting]

[Customize buttons for shooting]

You can assign common shooting functions to camera buttons that are easy for you to use. Different functions, for use when shooting still photos or movies, can be assigned to the same button.

1. Select : **Customize buttons for shooting** , .
2. Select a camera control.



- To switch to : **Customize buttons for playback** , press the < INFO > button.

3. Select a function to assign.

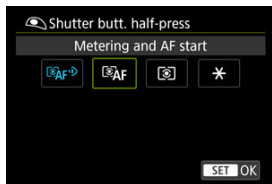

- Press < **SET** > to set it.
- You can configure advanced settings for functions labeled with **[INFO]** in the lower left of the screen by pressing the < **INFO** > button.

Note

- **[L-Fn]**: “AF Stop” or “Lens Function” button on super telephoto lenses with Image Stabilizer.
- **[Menu]**: “Menu direct” button on Speedlites.
- Only still photo shooting settings can be assigned to **[Eye]**, **[AF-ON]**, or **[Menu]**.
- To clear settings configured with **[Clear]**: **Customize buttons for shooting**, select **[Clear]**: **Clear all customized controls**.

Functions available for customization

AF

●: Default ○: Available for customization

			M-Fn		MODE	AF-ON				L-Fn	SET		
AF: Metering and AF start													
○*1	-	-	-	-	●	○	○	○	○	-	-	-	-
AF-OFF: AF stop													
-	○*1	○	○	○	○	○	○	○	○	●	-	-	-
AF point selection													
-	○*1	○	○	○	○	○	○	○	○	○	○	-	-
Direct AF point selection													
-	-	-	-	-	-	-	-	-	-	-	-	●	-
Set AF point to center													
-	○*1	○	○	○	○	○	○	○	○	○	○	-	-
Start/stop whole area AF tracking													
-	○*1	○	○	○	○	○	○	○	○	○	○	●	-
Switch to registered AF point*1													
-	-	-	-	-	○	○	○	○	○	○	-	-	-
AF↔: Switch to registered AF func.*1													
-	-	-	-	-	○	○	○	○	○	○	-	-	-
Direct AF area selection*1													
-	○	○	○	○	○	○	○	○	○	○	○	-	-
Direct select of sub to detect*1													
-	○	○	○	○	○	○	○	○	○	○	○	-	-
ONE SHOT AF ↔ Servo AF*1													
-	○	○	○	○	○	○	○	○	○	○	○	-	-

AF ^D : Moving AF pt, meter., AF by eye ctrl* ¹													
• ³	-	-	-	-	-	-	-	-	-	-	-	-	-
AF: Move AF point by eye control* ¹													
-	-	-	-	-	o	o	o	o	o	o	-	-	-
AF: Moving AF point, start AF by eye ctrl* ¹													
-	-	-	-	-	o	o	o	o	o	o	-	-	-
AF: Eye control* ¹													
-	o	o	o	o	o	o	o	o	o	o	o	-	-
AF: AF on detected subject* ¹													
-	-	-	-	-	o	o	o	o	o	o	-	-	-
AF: Eye Detection AF* ¹													
-	-	-	-	-	o	o	o	o	o	o	-	-	-
AF: Eye detection													
-	o* ¹	o	o	o	o	o	o	o	o	o	o	-	-
AF: Spot detection													
-	o* ¹	o	o	o	o	o	o	o	o	o	o	-	-
AF: Register people priority													
-	o* ¹	o	o	o	o	o	o	o	o	o	o	-	-
AF: Action Priority* ¹													
-	o	o	o	o	o	o	o	o	o	o	o	-	-
AF/ME: Focus mode													
-	o* ¹	o	o	o	o	o	o	o	o	o	o	-	-
PEAK: Peaking													
-	o* ¹	o	o	o	o	o	o	o	o	o	o	-	-
AF: Focus guide													
-	o* ¹	o	o	o	o	o	o	o	o	o	o	-	-
AF: Register focus preset													
-	o* ¹	o	o	o	o	o	o	o	o	o	o	-	-
AF: Recall focus preset													
-	o* ¹	o	o	o	o	o	o	o	o	o	o	-	-

L0: Subj. detect. AF*2													
-	-	o	o	o	o	o	o	o	o	o	o	-	-
Drive mode*1													
-	o	o	o	o	o	o	o	o	o	o	o	-	-
Switch  cont. shooting modes*1													
-	-	-	-	-	o	o	o	o	o	o	-	-	-

* 1: Cannot be assigned as a function available in movie recording.

* 2: Cannot be assigned as a function available in still photo shooting.

* 3: Default in still photo shooting.

Exposure Compensation

●: Default ○: Available for customization

		M-Fn		MODE	AF-ON				L-Fn	SET		
*AF-OFF : AE lock, AF stop												
-	○*1	○	○	○	○	○	○	○	○	-	-	-
 : Metering start												
○*1	-	-	-	-	-	-	-	-	-	-	-	-
* : AE lock												
-	○*1	○	○	○	○	○	○	○	○	-	-	-
* : AE lock (hold)												
-	○*1	○	○	○	○	●*4	○	○	○	-	-	-
* : AE lock (while button pressed)*1												
○	-	-	-	-	-	-	-	-	-	-	-	-
AEL/FEL: AE lock/FE lock*1												
-	○	○	○	○	○	●*3	○	○	○	-	-	-
* : Release AE Lock												
-	○*1	○	○	○	○	○	○	○	○	-	-	-
 : Expo comp (hold btn, turn)												
-	-	-	-	-	○	○	○	○	○	○	-	-
ISO: ISO speed												
-	○*1	○	○	○	○	○	○	○	○	○	-	-
ISO : Set ISO speed(hold btn, turn)												
-	-	-	-	-	○	○	○	○	○	○	-	-
 : Flash firing*1												
-	○	○	○	○	○	○	○	○	○	○	-	-
FEL : FE lock*1												
-	○	○	○	○	○	○	○	○	○	-	-	-

* 1: Cannot be assigned as a function available in movie recording.

* 3: Default in still photo shooting.

* 4: Default in movie recording.

Image

●: Default ○: Available for customization

		M-Fn		MODE	AF-ON				L-Fn	SET		
Image size selection* ¹												
-	○	○	○	○	○	○	○	○	○	○	-	-
RAW/JPEG: One-touch image quality setting* ¹												
-	○	○	○	○	○	○	○	○	○	○	-	-
RAW/JPEG H: One-touch image quality (hold)* ¹												
-	○	○	○	○	○	○	○	○	○	○	-	-
Cropping/aspect ratio* ¹												
-	○	○	○	○	○	○	○	○	○	○	-	-
Switch between crop/aspect* ¹												
-	○	○	○	○	○	○	○	○	○	○	-	-
Auto Lighting Optimizer												
-	○* ¹	○	○	○	○	○	○	○	○	○	-	-
WB: White balance selection												
-	○* ¹	○	○	○	○	○	○	○	○	○	-	-
WB WB Shift/Bkt.* ¹												
-	○	○	○	○	○	○	○	○	○	○	-	-
WB WB correction* ²												
-	-	○	○	○	○	○	○	○	○	○	-	-
Picture Style												
-	○* ¹	○	○	○	○	○	○	○	○	○	-	-
Record func+card/folder sel.												
-	○* ¹	○	○	○	○	○	○	○	○	○	-	-

* 1: Cannot be assigned as a function available in movie recording.

* 2: Cannot be assigned as a function available in still photo shooting.

Movies

●: Default ○: Available for customization

		M-Fn		MODE	AF-ON				L-Fn	SET			
False color* ²													
-	-	○	○	○	○	○	○	○	○	○	-	-	
Zebra* ²													
-	-	○	○	○	○	○	○	○	○	○	-	-	
Movie recording													
-	●* ¹⁺³	○	○	○	○	○	○	○	○	○	-	-	
Pause Movie Servo AF* ²													
-	-	○	○	○	○	○	○	○	○	○	-	-	
Audio Status* ²													
-	-	○	○	○	○	○	○	○	●* ⁴	○	○	-	-
ZOOM TELE: Cinema zoom (to tele)													
-	○* ¹	○	○	○	○	○	○	○	○	○	-	-	
ZOOM WIDE: Cinema zoom (to wide)													
-	○* ¹	○	○	○	○	○	○	○	○	○	-	-	
Custom Picture* ²													
-	-	○	○	○	○	○	○	○	○	○	-	-	
PRE Pre-recording* ²													
-	-	○	○	○	○	○	○	○	○	○	-	-	
Movie self-timer* ²													
-	-	○	○	○	○	○	○	○	○	○	-	-	
Standby: Low res.* ²													
-	-	○	○	○	○	○	○	○	○	○	-	-	

* 1: Cannot be assigned as a function available in movie recording.

* 2: Cannot be assigned as a function available in still photo shooting.

* 3: Default in still photo shooting.





* 4: Default in movie recording.

Operation

●: Default ○: Available for customization

		M-Fn		MODE	AF-ON				L-Fn	SET		
: Flash function settings*1												
-	○	○	○	○	○	○	○	○	○	○	-	●*3
: Quick flash group control*1												
-	○	○	○	○	○	○	○	○	○	○	-	○
DIAL FUNC: Dial function settings												
-	○*1	●	○	○	○	○	○	○	○	○	-	-
: Maximize screen brightness (temp)												
-	○*1	○	○	○	○	○	○	○	○	○	-	-
: Power off												
-	○*1	○	○	○	○	○	○	○	○	○	-	-
: Screen off												
-	○*1	○	○	○	○	○	○	○	○	○	-	-
UNLOCK : Unlock while button pressed												
-	-	-	-	-	-	-	-	○	○	-	-	-
: Short press: LCD illumination Long press: LCD info switching												
-	-	-	○	-	-	-	-	-	-	-	-	-
: Short press: LCD info switching Long press: LCD illumination												
-	-	-	●	-	-	-	-	-	-	-	-	-
: LCD panel illumination												
-	○*1	○	○	○	○	○	○	○	○	○	-	-
: LCD panel info switching												
-	○*1	○	○	○	○	○	○	○	○	○	-	-
MODE: Shooting mode settings												
-	○*1	○	○	●	○	○	○	○	○	○	-	-

: Switch to Custom shooting mode													
-	-	o	-	-	-	-	-	-	-	-	-	-	-
: Silent shutter function* ¹													
-	o	o	o	o	o	o	o	o	o	o	o	-	-
: Switch focus/control ring													
-	o* ¹	o	o	o	o	o	o	o	o	o	o	-	-
: Depth-of-field preview* ¹													
-	o	o	o	o	o	o	o	o	•* ³	o	o	-	-
AUTO : Reset selected item in Fv mode* ¹													
-	o	o	o	o	o	o	o	o	o	o	o	-	-
All Auto : Reset Tv/Av//ISO in Fv mode* ¹													
-	o	o	o	o	o	o	o	o	o	o	o	-	-
: Quick Control screen													
-	o* ¹	o	o	o	o	o	o	o	o	o	o	-	-
: Magnify/Reduce													
-	o* ¹	o	o	o	o	o	o	o	o	o	o	-	-
: Image replay													
-	o* ¹	o	o	o	o	o	o	o	o	o	o	-	-
: Magnify images during playback													
-	o* ¹	o	o	o	o	o	o	o	o	o	o	-	-
: Register/recall shooting func* ¹													
-	-	-	-	-	o	o	o	o	o	o	-	-	-
MENU : Menu display													
-	o* ¹	o	o	o	o	o	o	o	o	o	o	-	-
Tv STEP : Manual HF anti-flicker shoot(Tv)													
-	o* ¹	o	o	o	o	o	o	o	o	o	o	-	-
: Recom. Tv for HF anti-flicker shoot* ¹													
-	o	o	o	o	o	o	o	o	o	o	o	-	-
: Touch Shutter* ¹													
-	o	o	o	o	o	o	o	o	o	o	o	-	-

OVF V.A.: OVF sim. view assist*1													
-	○	○	○	○	○	○	○	○	○	○	○	-	-
  Display frame rate set.*1													
-	○	○	○	○	○	○	○	○	○	○	○	-	-
 Communication function													
-	○*1	○	○	○	○	○	○	○	○	○	○	-	-
 Create folder*1													
-	○	○	○	○	○	○	○	○	○	○	○	-	-
 Switch between VF/screen													
-	○*1	○	○	○	○	○	○	○	○	○	○	-	-
OFF: No function (disabled)													
-	○*1	○	○	○	○	○	○	○	○	○	○	○	○*1

* 1: Cannot be assigned as a function available in movie recording.

* 3: Default in still photo shooting.

Shutter btn function for movies

You can set the functions performed by pressing the shutter button halfway or completely during movie recording.

Caution

- In movie recording, the **[Shutter btn function for movies]** setting overrides any function assigned to the shutter button in **[Customize buttons for shooting]**.

1. Select **[Shutter btn function for movies]**.
2. Select an option.

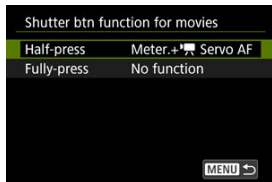

- **Half-press**
Specify the function performed by pressing the shutter button halfway.
- **Fully-press**
Specify the function performed by pressing the shutter button completely.

3. Select an option.

[Half-press] options

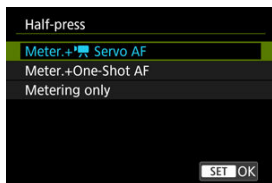



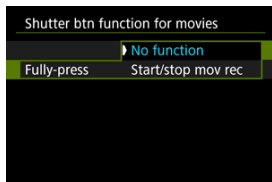



[Fully-press] options



- With **[Fully-press]** set to **[Start/stop mov rec]**, you can start/stop movie recording not only with the movie shooting button but also by pressing the shutter button completely, or by using Remote Switch RS-80N3 (sold separately).

Customize dials/control ring

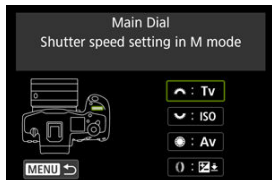

Frequently used functions can be assigned to the <  >/<  >/<  >/<  > dials.

1. Select [: Customize dials/control ring] (, ).
2. Select a camera control.



3. Select a function to assign.





















- Press <  > to set it.
- You can configure advanced settings for functions labeled with [**INFO**] in the lower left of the screen by pressing the <  > button.

Note



- To clear settings configured with [: Customize dials/control ring], select [: Clear all customized controls].

Functions available for dials







●: Default ○: Available for customization



Function				
 : Direct AF point selection	-	○	○	-
AF  : Select AF area	-	○	○	○
AF  : Select AF area(while holding metering button)	-	-	-	○
Tv : Change shutter speed	-	-	-	○
Av : Change aperture value	-	-	-	○
 : Exposure compensation	-	○	○	○
ISO : Set ISO speed	-	●	○	○
Tv  : Change shutter spd. (hold meter. btn)	-	-	-	○
Av  : Change aperture (hold meter. btn)	-	-	-	○
 : Exposure comp. (hold meter. btn)	-	-	-	●
ISO  : Set ISO speed(while holding metering button)	-	-	-	○
 : Flash exposure comp./output(while holding metering button)	-	-	-	○
Tv : Shutter speed setting in M mode	●	○	○	-
Av : Aperture setting in M mode	○	○	●	-
WB : White balance selection	-	○	○	○
 : Select color temperature	-	○	○	○
 : Picture Style	-	○	○	○
WB  : White balance selection(while holding metering button)	-	-	-	○
 : Select color temperature(while holding metering button)	-	-	-	○
 : Picture Style(while holding metering button)	-	-	-	○
OFF : No function (disabled)	○	○	○	○

Note

- The <  > dial cannot be customized in [Fv] mode.
- : Control ring on RF lenses and mount adapters.



direction to set Tv/Av

Dial turning direction when setting the shutter speed and aperture value can be reversed. Reverses the turning direction of the <  >, <  >, and <  > dial in [M] shooting mode and only the <  > dial in other shooting modes. The direction of the <  > and <  > dials in [M] mode matches the direction to set exposure compensation in [P], [Tv], and [Av] modes.

- : Normal
- : Reverse direction

direction to set Tv/Av

The direction to set the shutter speed and aperture value with the control ring of RF or RF-S lenses or mount adapters can be reversed.



- : Normal
- : Reverse direction

Switch when shooting

Functions assigned to the Main dial and Quick control dial 2 can be reversed.



- **OFF: Disable**
- **ON: Enable**

Touch Shutter



Touch Shutter can be specified. When set to [Enable],  display in the lower left of the shooting screen changes to , and Touch Shutter is enabled. For Touch Shutter instructions, see [Shooting with the Touch Shutter](#).

Multi function lock

Specify camera controls to lock when the Multi-function lock is enabled. This can help prevent accidentally changing settings.

1. Select [: Multi function lock] (, ).
2. Select camera controls to lock.



- Select a camera control and press < > to display [].

3. Select [OK].

- Setting the power/multi-function lock switch to <LOCK > locks the selected [] camera controls.

Note

- An asterisk "*" to the right of [: Multi function lock] indicates that the default setting has been modified.

Touch & drag AF settings

You can move the AF point or Zone AF frame by tapping or dragging on the screen as you look through the viewfinder.

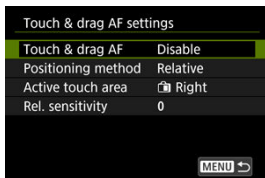

Touch & drag AF

Select [**Enable**] to enable Touch and Drag AF.

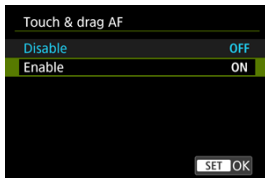

Positioning method

You can set how positions are specified by tapping or dragging.

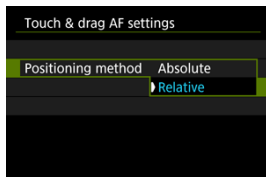

- **Absolute**

The AF point moves to the tapped or dragged position on the screen.

- **Relative**

The AF point moves in the direction you drag, by an amount corresponding to the amount you drag, no matter where you tap the screen.

Active touch area

You can specify the area of the screen used for tap and drag operations.

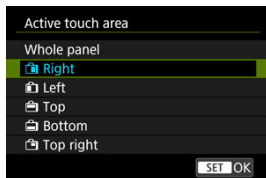

Note

- A round orange frame [⊞] is displayed when you tap the screen with **[AF: AF area]** set to **[Whole area AF]**. After you lift your finger at the position to move the AF point to, [⊞] is displayed and that subject is tracked. To cancel subject selection, tap [OFF].

Rel. sensitivity

By setting [Positioning method] to [Relative], you can specify the amount of movement in response to tapping or dragging.

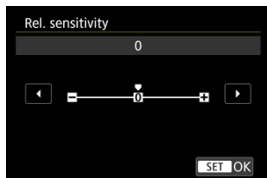



For faster AF point positioning, set toward the positive end, and for slower positioning, set toward the negative end.

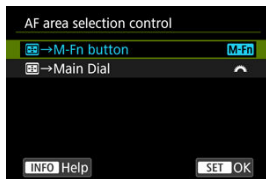

AF area selection control

You can set how AF area selection methods are switched.



- **M-Fn button**
Press the <  > button, then the < **M-Fn** > button. Each press switches the AF area.
- **Main Dial**
Press the <  > button, then turn the <  > dial to switch the AF area.

Note

- When [ **Main Dial**] is set, use <  > to move the AF point horizontally.

sensitivity- AF pt select

You can adjust Multi-controller sensitivity, which applies to AF point positioning.

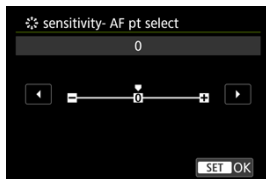

Focus/control ring

Menu-based switching of lens focus/control ring functionality.

Caution

- Available when using lenses that have a combination focusing ring/control ring but have no switch to switch between these feature.





- **FOCUS: Use as focus ring**

The ring works as a focusing ring.

- **CONTROL: Use as control ring**

The ring works as a control ring.



Note

- To restrict [**AF: Focus mode**] to [**AF**] when [**Use as control ring**] is selected, press the <  > button and add a checkmark [] to [**Focus mode is AF when used as a control ring**].
- Switching is also possible from the Quick Control screen, when customized with [: **Customize Quick Controls**] ().

Focus ring rotation

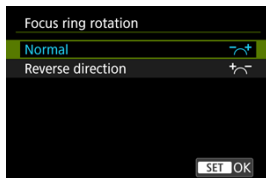
You can reverse the direction that the focusing ring of RF lens is rotated to adjust settings.





- : Normal
- : Reverse direction

RF lens MF focus ring sensitivity

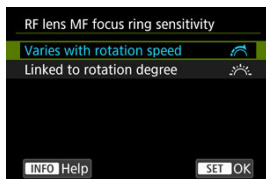
You can set the sensitivity of the RF lens focusing ring.





- : **Varies with rotation speed**
Focusing ring sensitivity varies depending on rotation speed.
- : **Linked to rotation degree**
The focal position is adjusted based on the amount of rotation, regardless of the rotation speed.



[Customized controls when playback]

Customize buttons for playback

You can assign common playback functions to camera buttons that are easy for you to use.

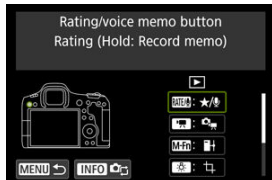
1. Select [: Customize buttons for playback] ().
2. Select a camera control.



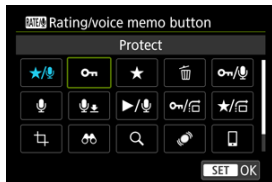

- To switch to [: Customize buttons for shooting] (), press the <INFO> button.

3. Select a function to assign.







- Press <SET> to set it.
- You can configure advanced settings for functions labeled with [**INFO**] in the lower left of the screen by pressing the <INFO> button.

Note

- To clear settings configured with [: Customize buttons for playback], select [: Clear all customized controls].

Functions available for customization

●: Default ○: Available for customization

					
Protect					
○	○	○	○	○	○
★: Rating					
○	○	○	○	○	○
Eraser icon: Erase images					
○	○	○	○	○	○
Microphone icon: Protect(Hold:Record memo)					
○	-	-	-	-	-
★/Microphone icon: Rating (Hold: Record memo)					
●	-	-	-	-	-
Microphone icon: Hold to record voice memo					
○	-	-	-	-	-
Microphone icon: Press to record voice memo					
○	○	○	○	○	○
Play button/Microphone icon: Play memo(Hold:Rec. memo)					
○	-	-	-	-	-
Protect icon: Protect (image jump w/ M-Fn icon)					
○	○	○	○	○	○
★/Protect icon: Rating (image jump w/ M-Fn icon)					
○	○	○	○	○	○
Crop icon: Cropping					
○	○	○	●	○	○













 : Image search					
<input type="radio"/>	<input type="radio"/>	<input type="radio"/>	<input type="radio"/>	<input type="radio"/>	<input type="radio"/>
 : Magnify/Reduce					
<input type="radio"/>	<input type="radio"/>	<input type="radio"/>	<input type="radio"/>	<input type="radio"/>	<input type="radio"/>
 : Switch  display					
<input type="radio"/>	<input type="radio"/>	<input type="radio"/>	<input type="radio"/>	<input type="radio"/>	<input type="radio"/>
 : Send images to smartphone					
<input type="radio"/>	<input type="radio"/>	<input type="radio"/>	<input type="radio"/>	<input type="radio"/>	<input type="radio"/>
 : Transfer images to FTP server					
<input type="radio"/>	<input type="radio"/>	<input checked="" type="radio"/>	<input type="radio"/>	<input type="radio"/>	<input type="radio"/>
 : Image sel./transfer (FTP Server)					
<input type="radio"/>	<input type="radio"/>	<input type="radio"/>	<input type="radio"/>	<input type="radio"/>	<input type="radio"/>
 : Image sel./transfer (EOS Utility)					
<input type="radio"/>	<input type="radio"/>	<input type="radio"/>	<input type="radio"/>	<input type="radio"/>	<input type="radio"/>
 : Same as Custom. Button when shoot.					
-	<input checked="" type="radio"/>	<input type="radio"/>	<input type="radio"/>	<input checked="" type="radio"/>	<input type="radio"/>
OFF : No function (disabled)					
<input type="radio"/>	<input type="radio"/>	<input type="radio"/>	<input type="radio"/>	<input type="radio"/>	<input checked="" type="radio"/>

Image jump w/

To set how the camera jumps through images, you can turn the <  > dial on the playback screen in single-image display.

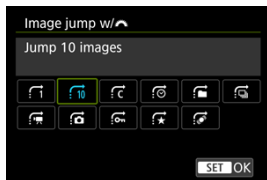

Note

- With [**Jump images by the specified number**], you can turn the <  > dial to select the number of images to jump by.
- With [**Display by image rating**], turn the <  > dial to select the rating (). Selecting ★ will show all rated images as you browse.
- You can also change the jump method by pressing <  > horizontally on the playback screen in single-image display.

Img jump w/ +

To set how the camera jumps through images, you can turn the < > dial while pressing the button assigned to [] [] on the playback screen in single-image display.



Note



- You can configure this function when assigning [] [] to a button in [: **Customize buttons for playback**] ().
- With [**Jump images by the specified number**], you can turn the < > dial to select the number of images to jump by.
- With [**Display by image rating**], turn the < > dial to select the rating ().
Selecting will show all rated images as you browse.

Switch during playback

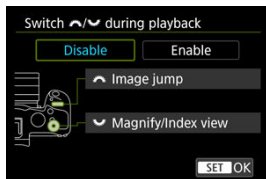
You can switch the functions assigned to these dials, as used on the playback screen.



- **Disable**

Assigns **[Image jump]** to the <  > dial and **[Magnify/Index view]** to the <  > dial.

- **Enable**

Assigns **[Magnify/Index view]** to the <  > dial and **[Image jump]** to the <  > dial.

Note

- Corresponding icons in menus and on screens such as the Quick Control and Magnify/Reduce screen are changed accordingly.

[Customized controls/Reset]

Eye control ◀▶

Eye control can be specified. For eye control instructions, see [Using Eye Control](#).

Touch control

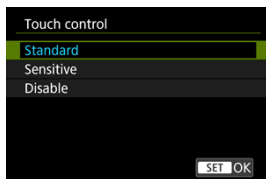

- [Sensitive] makes the touch-screen panel more responsive than [Standard].
- To disable touch operations, select [Disable].

⚠ Caution

Precautions for touch-screen panel operations

- Do not use sharp objects such as fingernails or ballpoint pens for touch operations.
- Do not use wet fingers for touch operations. If the screen has any moisture or if your fingers are wet, the touch-screen panel may not respond or malfunction may occur. In this case, turn off the power and wipe off the moisture with a cloth.
- Attaching a commercially available protective sheet or a sticker on the screen may impair responsiveness to touch operations.
- The camera may not respond as well if you quickly perform touch operation when [Sensitive] is set.

Clear all customized controls

Selecting [🗑️: **Clear all customized controls**] clears all control customization settings.

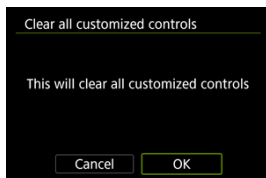

You can adjust camera functions in detail to suit your shooting preferences. You can also add menu items and Custom Functions that you adjust frequently to My Menu tabs.

- [Tab Menus: Custom Functions](#)
- [Custom Function Setting Items](#)
- [Tab Menus: My Menu](#)
- [Registering My Menu](#)

Tab Menus: Custom Functions

● Shooting mode/Exposure

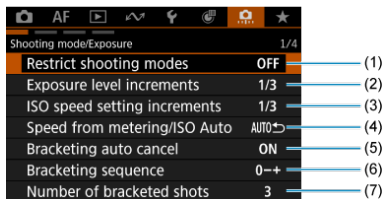

- (1) [Restrict shooting modes](#)
- (2) [Exposure level increments](#)
- (3) [ISO speed setting increments](#)
- (4) [Speed from metering/ISO Auto](#)
- (5) [Bracketing auto cancel](#)
- (6) [Bracketing sequence](#)
- (7) [Number of bracketed shots](#)

● Exposure

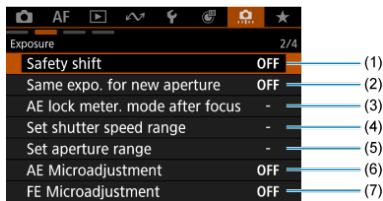

- (1) [Safety shift](#)
- (2) [Same expo. for new aperture](#)
- (3) [AE lock meter. mode after focus](#)
- (4) [Set shutter speed range](#)
- (5) [Set aperture range](#)
- (6) [AE Microadjustment](#)
- (7) [FE Microadjustment](#)

● Drive

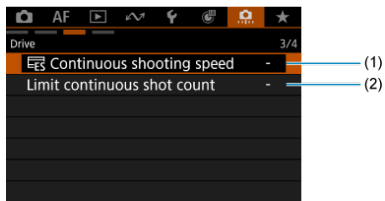

- (1) [Continuous shooting speed](#)
- (2) [Limit continuous shot count](#)

● Various settings/Reset

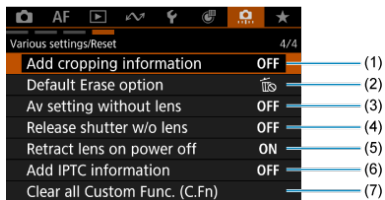

- (1) [Add cropping information](#)
- (2) [Default Erase option](#)
- (3) [Av setting without lens](#)
- (4) [Release shutter w/o lens](#)
- (5) [Retract lens on power off](#)
- (6) [Add IPTC information](#)
- (7) [Clear all Custom Func. \(C.Fn\)](#)

Selecting []: **Clear all Custom Func. (C.Fn)**] clears all Custom Function settings.

Custom Function Setting Items

 [\[Shooting mode/Exposure\]](#)

 [\[Exposure\]](#)

 [\[Drive\]](#)

 [\[Various settings/Reset\]](#)

You can customize camera features on the [] tab to suit your shooting preferences. Any settings you change from default values are displayed in blue.

[Shooting mode/Exposure]

Restrict shooting modes

You can restrict the shooting modes available with the <MODE> button. Select available shooting modes [Fv/P/Av/M/Tv/BULB/C1/C2/C3], then press <SET> to add a checkmark [✓]. Select [OK] to register the setting.

Caution

- Restricted shooting mode settings are not registered to [C1], [C2], or [C3].
- The [✓] mark cannot be cleared from all nine modes at the same time.

Exposure level increments

Sets 1/2-stop increments for the shutter speed, aperture value, exposure compensation, AEB, flash exposure compensation, etc.

- 1/3: 1/3-stop
- 1/2: 1/2-stop

Note

- Display when set to [1/2-stop] is as follows.



ISO speed setting increments

You can change the manual ISO speed setting increment to a whole stop.



- 1/3: 1/3-stop
- 1/1: 1-stop

Note

- Even if [1-stop] is set, ISO speed will be automatically set in 1/3-stop increments when ISO Auto is set.

Speed from metering/ISO Auto

You can set the ISO speed status after the metering timer ends in cases where, for ISO Auto operation in [P]/[Tv]/[Av]/[M]/[BULB] mode, the camera has adjusted the ISO speed during metering or during the metering timer.

- **AUTO** : Restore Auto after metering
- **AUTO** : Retain speed after metering

Bracketing auto cancel

You can specify to cancel AEB and white balance bracketing when the power switch is set to <OFF>.

- **ON**: Enable
- **OFF**: Disable

Bracketing sequence

The AEB shooting sequence and white balance bracketing sequence can be changed.

- **0-+**: 0, -, +
- **-0+**: -, 0, +
- **+0-**: +, 0, -

AEB	White Balance Bracketing	
	B/A Direction	M/G Direction
0: Standard exposure	0: Standard white balance	0: Standard white balance
-: Underexposure	-: Blue bias	-: Magenta bias
+: Overexposure	+: Amber bias	+: Green bias

Number of bracketed shots

The number of shots taken with AEB and white balance bracketing can be changed. When **[Bracketing sequence]** is set to **[0, -, +]**, the bracketed shots will be taken as shown in the following table.

- **3: 3 shots**
- **2: 2 shots**
- **5: 5 shots**
- **7: 7 shots**

(1-stop/step increments)

	1st Shot	2nd Shot	3rd Shot	4th Shot	5th Shot	6th Shot	7th Shot
3: 3 shots	Standard (0)	-1	+1				
2: 2 shots	Standard (0)	±1					
5: 5 shots	Standard (0)	-2	-1	+1	+2		
7: 7 shots	Standard (0)	-3	-2	-1	+1	+2	+3



Note

- If **[2 shots]** is set, you can select the + or - side when setting the AEB range. With white balance bracketing, the second shot is adjusted toward the negative side for the B/A or M/G direction.

Safety shift

If the subject brightness changes and the standard exposure cannot be obtained within the autoexposure range, the camera will automatically change the manually selected setting to obtain the standard exposure. **[Shutter speed/Aperture]** applies to **[Tv]** or **[Av]** mode. **[ISO speed]** applies to **[P]**, **[Tv]**, or **[Av]** mode.

- **OFF: Disable**
- **Tv/Av: Shutter speed/Aperture**
- **ISO: ISO speed**



Note

- Safety shift overrides any changes to **[ISO speed range]** or **[Min. shutter spd.]** from default settings in **[Camera: ISO speed settings]** if standard exposure cannot be obtained.
- The minimum and maximum limits for the safety shift with the ISO speed are determined by **[Auto range]** (Ⓒ). However, if the manually set ISO speed exceeds the **[Auto range]**, the safety shift will take effect up or down to the manually set ISO speed.
- Safety shift will take effect as necessary even when flash is used.



Same expo. for new aperture

The maximum aperture value may decrease (the lowest f/number may increase) in **[M]** mode (manual exposure shooting) with ISO speed set manually (except when set to ISO Auto) if you (1) Change lenses, (2) Attach an extender, or (3) Use a zoom lens with a variable maximum aperture value. This function prevents the corresponding underexposure by adjusting ISO speed or shutter speed (Tv value) automatically to maintain the same exposure as before (1), (2), or (3).

With **[ISO speed/Shutter speed]**, the ISO speed is automatically adjusted within the ISO speed range. If exposure cannot be maintained by adjusting ISO speed, shutter speed (Tv value) is automatically adjusted.

- **OFF: Disable**
- **ISO: ISO speed**
- **ISO/Tv: ISO speed/Shutter speed**
- **Tv: Shutter speed**

Caution

- Does not respond to changes in effective aperture value from changes in magnification when macro lenses are used.
- Cannot provide the same exposure as before (1), (2), or (3) if **[ISO speed]** is set and the exposure cannot be maintained at speeds in **[ISO speed range]**.
- Cannot provide the same exposure as before (1), (2), or (3) if **[Shutter speed]** is set and the exposure cannot be maintained at speeds set in **[: Set shutter speed range]**.
- Shutter speed is limited to 1/8000 when **[: Shutter mode]** is **[Electronic ** and **[Same expo. for new aperture]** is set to **[Shutter speed]** or **[ISO speed/Shutter speed]**.

Note

- Also responds to changes in the highest f/number (minimum aperture).
- The original exposure setting is restored if you perform (1), (2), or (3) with **[ISO speed]**, **[ISO speed/Shutter speed]**, or **[Shutter speed]** set and do not adjust ISO speed, shutter speed, or aperture value before returning the camera to the original state, before (1), (2), or (3).
- Shutter speed may change to maintain exposure if the ISO speed increases to an expanded ISO speed when **[ISO speed]** is set.

AE lock meter. mode after focus

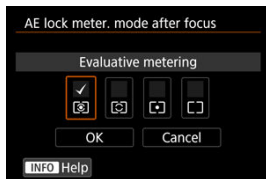

For each metering mode, you can specify whether to lock the exposure (AE lock) once subjects are in focus with One-Shot AF. The exposure will be locked while you keep pressing the shutter button halfway. Select metering modes for AE lock and add a checkmark [✓]. Select [OK] to register the setting.

Set shutter speed range

You can set the shutter speed range for each [📷: Shutter mode] option. In [Fv], [Tv], or [M] mode, you can set the shutter speed manually within your specified range. In [P] or [Av] mode, or in [Fv] mode with shutter speed set to [AUTO], the shutter speed is set automatically within your specified range (except for movie recording). Select [OK] to register the setting.

● Mech shutter/elec 1st-curtain

- **Lowest speed:** Can be set in a range of 30 sec.–1/4000 sec.
- **Highest speed:** Can be set in a range of 1/8000 sec.–15 sec.

● Electronic $\frac{1}{25}$

- **Lowest speed:** Can be set in a range of 30 sec.–1/16000 sec.
- **Highest speed:** Can be set in a range of 1/32000 sec.–15 sec.

⚠ Caution

- Setting [Highest speed] for [Electronic $\frac{1}{25}$] to 1/32000 sec. will not limit highest speeds faster than 1/8000 sec. in [P] or [Av] mode.
- This setting does not apply to high-frequency anti-flicker shooting.

Set aperture range

You can set the aperture value range. In **[Fv]**, **[Av]**, **[M]**, or **[BULB]** mode, you can set the aperture value manually within your specified range. In **[P]** or **[Tv]** mode, or in **[Fv]** mode with the aperture value set to **[AUTO]**, the aperture value is set automatically within your specified range. Select **[OK]** to register the setting.

- **Max. aperture**
Can be set in a range of $f/1.0$ – $f/64$.
- **Min. aperture**
Can be set in a range of $f/91$ – $f/1.4$.



Note

- The available aperture value range varies depending on the lens's minimum and maximum aperture value.

AE Microadjustment

Caution

- **Normally, this adjustment is not required. Perform this adjustment only if necessary. Note that performing this adjustment may prevent you from obtaining suitable exposure.**

You can fine-tune the standard exposure level. Effective if images in autoexposure shooting without exposure compensation usually seem underexposed or overexposed.

- **OFF: Disable**
- **ON: Enable**

To access the adjustment screen, select **[Enable]**, then press the **< [Q] >** button. Standard exposure can be adjusted in a range of ± 1 stop, in 1/8-stop increments. Set on the positive side if shots tend to be underexposed and on the negative side if they tend to be overexposed.

Caution

- The effective exposure compensation range available in movie recording remains unchanged if you adjust standard exposure with AE Microadjustment, and only the standard exposure level is changed. An exposure compensation amount equivalent to the AE Microadjustment amount is not applied to resulting images if the effective exposure compensation range in movie recording is exceeded (for example, an exposure compensation amount of +1 stop is not applied if AE Microadjustment is set to +1 stop and exposure compensation to +3 stops).

Note

- Exposure compensation can be set up to ± 3 stops from the adjusted standard exposure when shooting.

⚠ Caution



- **Normally, this adjustment is not required. Perform this adjustment only if necessary. Note that performing this adjustment may prevent you from obtaining suitable flash exposure.**

You can fine-tune the standard flash exposure level. Effective if main subjects in autoflash shooting without flash exposure compensation usually seem underexposed or overexposed.

- **OFF: Disable**
- **ON: Enable**

To access the adjustment screen, select **[Enable]**, then press the < **Q** > button. Standard flash exposure can be adjusted in a range of ± 1 stop, in 1/8-stop increments. Set on the positive side if main subjects tend to be underexposed and on the negative side if they tend to be overexposed.

Continuous shooting speed

You can set the continuous shooting speed for  High-speed continuous shooting +,  High-speed continuous shooting, and  Low-speed continuous shooting. Select **[OK]** to register the setting.



- **High speed continuous +**
Can be set in a range of 30–3 shots/sec.
- **High speed**
Can be set in a range of 20–2 shots/sec.
- **Low speed**
Can be set in a range of 15–1 shots/sec.

Caution

- Applies only when **[Shutter mode]** is set to **[Electronic **.
- Even if you set a continuous shooting speed, continuous shooting at the specified speed may not be possible under some shooting conditions. For precautions on continuous shooting, see [Selecting the Drive Mode](#).

Limit continuous shot count

You can limit the maximum burst for continuous shooting, so that while you keep holding down the shutter button with continuous shooting set, the camera automatically stops shooting after the specified number of continuous shots.

You can set it from 99 to 2 exposures. Pressing the   button returns the setting to **[Disable]**.

When **[Disable]** is set, continuous shooting can continue up to the maximum burst shown at right in the viewfinder.



Add cropping information

Adding cropping information displays vertical lines for the aspect ratio specified in shooting, so that you can compose shots as if shooting with a medium- or large-format camera (6×6 cm, 4×5 inch, and so on).

When you shoot, instead of cropping images recorded to the card, the camera adds aspect ratio information to images for cropping in the Digital Photo Professional (EOS software). You can import images to Digital Photo Professional on a computer and easily crop images to the aspect ratio set at the time of shooting.

- **OFF: Disable**
- **6:6: Aspect ratio 6:6**
- **3:4: Aspect ratio 3:4**
- **4:5: Aspect ratio 4:5**
- **6:7: Aspect ratio 6:7**
- **5:6: Aspect ratio 10:12**
- **5:7: Aspect ratio 5:7**

Caution

- Cropping information can only be added when [:  **Cropping/aspect ratio**] is set to [**Full-frame**].
- JPEG or HEIF images are not saved at the cropped size if you use the camera to process RAW images with cropping information (). In this case, RAW processing produces JPEG or HEIF images with cropping information.

Note

- Vertical lines indicating your specified aspect ratio are displayed on the screen.

Default Erase option

You can set which option is selected by default in the erase menu (🗑️), which is accessed by pressing the < 🗑️ > button during image playback or during review after shooting.

By setting an option other than [Cancel], you can simply press < (SET) > to erase images quickly.

- 🗑️: [Cancel] selected
- 🗑️: [Erase] selected
- RAW: [Erase RAW] selected
- J/H: [Erase non-RAW] selected
- 🗑️: [Erase voice memo] selected

⚠️ Caution

- Be careful not to erase images accidentally when an option other than [Cancel] is set.

Av setting without lens

You can specify whether the aperture value can still be set without a lens attached.

- OFF: Disable
- ON: Enable

Aperture value can still be set without a lens attached. Convenient when you want to prepare for shooting and have already decided about the aperture value.

Release shutter w/o lens

You can specify whether shooting still photos or movies is possible without a lens attached.

- **OFF: Disable**
- **ON: Enable**

Retract lens on power off

You can set whether to retract gear-type STM lenses (such as RF35mm F1.8 Macro IS STM) automatically when the camera's power switch is set to < **OFF** >.

- **ON: Enable**
- **OFF: Disable**

Caution

- With auto power off, the lens will not retract regardless of the setting.
- Before detaching the lens, make sure that it is retracted.

Note

- When [**Enable**] is set, this function takes effect regardless of the lens's focus mode switch setting (AF or MF).

Add IPTC information



Registering IPTC (International Press Telecommunications Council) information to the camera from software such as the EOS application EOS Utility enables you to record (embed) this information in JPEG/HEIF/RAW still photos at the time of shooting. **This is helpful in file management and other tasks using the IPTC information.** For instructions on registering IPTC information to the camera and details on the information you can register, refer to the software instruction manual.

- **OFF: Disable**
- **ON: Enable**

Caution

- IPTC information is not added when you record movies.





Note

- During playback, you can check whether IPTC information was added.
- You can use Digital Photo Professional (EOS software) to check IPTC information in images.
- IPTC information registered to the camera is not erased if you select [: **Clear all Custom Func. (C.Fn)**] (), but the setting changes to [**Disable**].

Clear all Custom Func. (C.Fn)

Selecting [: **Clear all Custom Func. (C.Fn)**] clears all Custom Functions settings.

Note

- Settings for [: **AE Microadjustment**] and [: **FE Microadjustment**] are set to [**Disable**] but not cleared when [: **Clear all Custom Func. (C.Fn)**] is performed. Note that although information added using [: **Add IPTC information**] is retained, the setting changes to [**Disable**].

Tab Menus: My Menu

- My Menu management

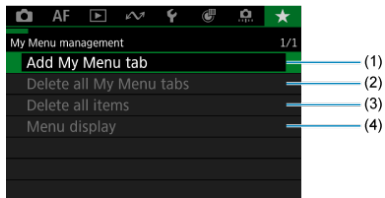

- (1) [Add My Menu tab](#)
- (2) [Delete all My Menu tabs](#)
- (3) [Delete all items](#)
- (4) [Menu display](#)

Registering My Menu

- [Creating and Adding My Menu Tabs](#)
- [Registering Menu Items on My Menu Tabs](#)
- [My Menu Tab Settings](#)
- [Deleting All My Menu Tabs/Deleting All Items](#)
- [Menu Display Settings](#)

On the My Menu tab, you can register menu items and Custom Functions you often adjust.

Creating and Adding My Menu Tabs

1. Select [**★**: Add My Menu tab] (🔗).
2. Select [OK].

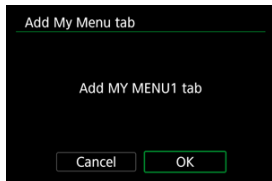

- You can create up to five My Menu tabs by repeating steps 1 and 2.

1. Select [MY MENU*: Configure].

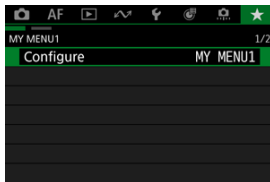

2. Select [Select items to register].

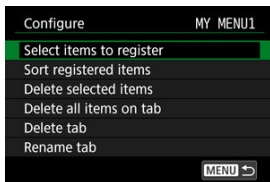

3. Register the desired items.

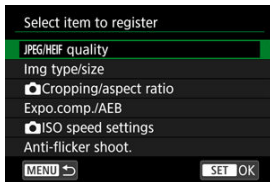

- Select an item, then press < (SET) >.
- Select [OK] on the confirmation screen.
- You can register up to six items.
- To return to the screen in step 2, press the < MENU > button.

My Menu Tab Settings

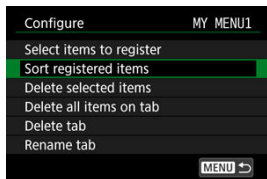

You can sort and delete items on the menu tab, and rename or delete the menu tab itself.

- **Sort registered items**

You can change the order of the registered items in My Menu. Select [**Sort registered items**], select an item to rearrange, then press < (SET) >. With [↕] displayed, turn the < (◂) > dial to rearrange the item, then press < (SET) >.

- **Delete selected items/Delete all items on tab**

You can delete any of the registered items. [**Delete selected items**] deletes one item at a time, and [**Delete all items on tab**] deletes all the registered items on the tab.

- **Delete tab**

You can delete the current My Menu tab. Select [**Delete tab**] to delete the [**MY MENU***] tab.





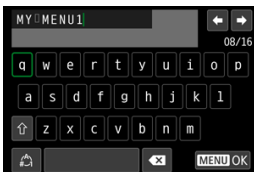

- **Rename tab**

You can rename the My Menu tab from [MY MENU*].

1. **Select [Rename tab].**

2. **Enter text.**



- Use the <  > or <  > dial or <  > to select a character, then press <  > to enter it.
- By selecting [], you can change the input mode.
- To delete single characters, select [] or press the <  > button.

3. **Confirm input.**

- Press the < **MENU** > button, then select [**OK**].

Deleting All My Menu Tabs/Deleting All Items

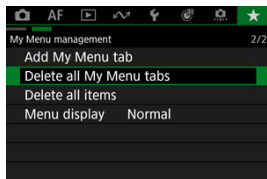

You can delete all the created My Menu tabs or My Menu items registered on them.

- **Delete all My Menu tabs**

You can delete all My Menu tabs you created. When you select [**Delete all My Menu tabs**], all the tabs from [**MY MENU1**] to [**MY MENU5**] will be deleted and the [**★**] tab will revert to its default.

- **Delete all items**

You can delete all the items registered under the [**MY MENU1**] to [**MY MENU5**] tabs. The tabs themselves will remain. When [**Delete all items**] is selected, all the items registered on all the created tabs will be deleted.

! Caution

- Performing [**Delete tab**] or [**Delete all My Menu tabs**] will also delete tab names renamed with [**Rename tab**].

Menu Display Settings

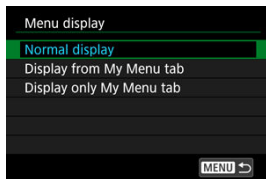

You can select **[Menu display]** to set the menu screen that is to appear first when you press the <MENU> button.

- **Normal display**

Displays the last displayed menu screen.

- **Display from My Menu tab**

Displays with the [★] tab selected.

- **Display only My Menu tab**

Restricts display to the [★] tab ([CAMERA]/[AF]/[▶]/[⌂]/[Y]/[G]/[...]) tabs are not displayed).

Reference

This chapter provides reference information on camera features.

- [Importing Images to a Computer](#)
- [Importing Images to a Smartphone](#)
- [Using a USB Power Adapter to Charge/Power the Camera](#)
- [Using a Battery Grip](#)
- [Using a Cooling Fan](#)
- [Troubleshooting Guide](#)
- [Error Codes](#)
- [Information Display](#)
- [Specifications](#)

Importing Images to a Computer

[Connecting to a Computer with an Interface Cable](#)

[Using a Card Reader](#)

[Connecting to a Computer via Wi-Fi](#)

You can use EOS software to import images from the camera to a computer. If you will import many images, consider using a household power outlet accessory (sold separately).

Connecting to a Computer with an Interface Cable

1. Install EOS Utility () .
2. In [: Choose USB connection app], select [Photo Import/Remote Control] () .
3. Connect the camera to the computer.

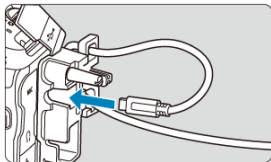

- Use the interface cable included with the camera.
- When connecting the cable to the camera, use the cable protector () and insert the plug in the digital terminal.
- Insert the other end of the cable into the computer's USB terminal (Type-C).

4. Use EOS Utility to import the images.

- Refer to the EOS Utility Instruction Manual.

Using a Card Reader

You can use a card reader to import images to a computer.

1. **Install Digital Photo Professional** (📷).
2. **Insert the card into the card reader.**
3. **Use Digital Photo Professional to import the images.**

- Refer to the Digital Photo Professional Instruction Manual.



Note

- When using a card reader instead of EOS software to transfer images from the camera to a computer, copy the folders on the card (CRM, DCIM, and XFVC) to the computer.

Connecting to a Computer via Wi-Fi

You can connect the camera to the computer via Wi-Fi and import images to the computer (🔗).



Note

- By connecting to an FTP server, you can send images on the camera to a computer (🔗).

Importing Images to a Smartphone



[☑ Preparation](#)

[☑ Using Camera Connect](#)

[☑ Using Smartphone Features](#)

You can import images captured with the camera to a smartphone by connecting the smartphone to the camera with Multi-Function Shoe Adapter for Smartphone Link AD-P1 (sold separately, for Android smartphones only) or a USB cable.

Preparation

1. Select an option in [: Choose USB connection app] ().
 - Select [**Photo Import/Remote Control**] when connecting an Android smartphone, or when connecting an iPhone and using the Photos app.
 - Select [**Canon app(s) for iPhone**] when connecting an iPhone and using Camera Connect.
 - After the settings are complete, turn the camera off.

2. Connect the camera to the smartphone with AD-P1 or a USB cable.
 - When using AD-P1, refer to the instruction manual included with AD-P1.
 - Use of a Canon USB cable (Interface Cable IFC-100U or IFC-400U) is recommended when connecting Android smartphones.
 - For details on USB cables used to connect iPhones, visit the Canon website ().

1. **Install Camera Connect on the smartphone and start it.**
 - For details on installing Camera Connect, see [Installing the App on a Smartphone](#).
2. **Turn the camera on.**
3. **Tap [Images on camera].**
 - Select images displayed to import them to the smartphone.

1. Turn the camera on.
2. Use the smartphone to import images.
 - Android smartphones: Use Camera Connect to import images. ([📷](#))
 - iPhones: Start the Photos app, then import images from the card.

Using a USB Power Adapter to Charge/Power the Camera

Using USB Power Adapter PD-E2 (sold separately), you can charge Battery Pack LP-E6P without removing it from the camera. The camera can also be powered.

Charging

1. Connect the USB power adapter.

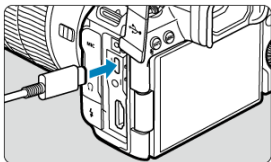

- With the camera power switch set to <OFF>, insert the USB power adapter plug fully into the <  > terminal.

2. Connect the power cord.

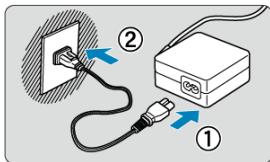

- Connect the power cord to the USB power adapter and plug the other end into a power outlet.

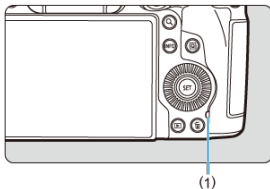

- Charging begins, and the access lamp (1) is lit in green.
- [⚡] is displayed on the LCD panel.
- When charging is finished, the access lamp turns off.

Supplying power

To power the camera without charging batteries, set the camera power switch to **<ON>**. However, batteries are charged during auto power off.

The battery level indicator is gray when power is supplied.

To change from powering the camera to charging, set the camera power switch to **<OFF>**.

 **Caution**

- The camera cannot be powered unless a battery pack is in it.
- When batteries are depleted, the adapter charges them. In this case, power is not supplied to the camera.
- To protect the battery pack and keep it in optimal condition, do not charge it continuously for more than 24 hours.
- Charged batteries gradually lose their charge, even when they are not used.
- If the charging lamp fails to light up or a problem occurs during charging (shown by the access lamp blinking in green), unplug the power cord, reinsert the battery, and wait a few minutes before plugging it in again. If the problem persists, take the camera to the nearest Canon Service Center.
- The charging time required and the amount charged vary depending on ambient temperature and remaining capacity.
- For safety, charging in low temperatures takes longer.
- The remaining battery level may decline when power is supplied to the camera. To avoid running out of battery power, use a fully charged battery.
- Before disconnecting USB power adapters, set the camera power switch to **<OFF>**.
- Some commercially available power adapters have been confirmed to charge and power the camera. For details, check the Canon website ([🌐](#)).
- You can also charge Battery Pack LP-E6NH/LP-E6N ([🌐](#)).

Using a Battery Grip

- ☑ [Attaching to the Camera](#)
- ☑ [Loading Batteries](#)
- ☑ [Using a Household Power Outlet](#)
- ☑ [Button and Dial Operations](#)
- ☑ [Using a USB Power Adapter to Charge/Power the Camera](#)

Equipped with buttons and dials for vertical shooting, Battery Grip BG-R20/BG-R20EP is an optional camera accessory that can power the camera with two batteries. BG-R20EP is also equipped with an Ethernet RJ-45 terminal, which enables the camera to be used with a wired LAN (☑).

Attaching to the Camera

1. Remove the contact covers.

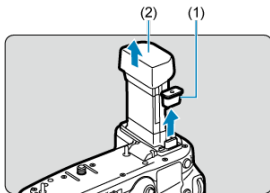

- Remove contact covers (1) and (2) on the battery grip.

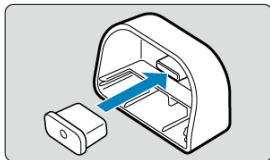

- Attach battery grip contact cover (1) to (2) for storage.

2. Remove the battery compartment cover.

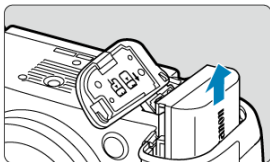

- Turn off the camera before removing the battery.

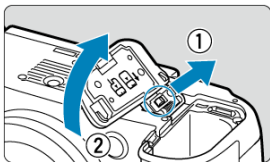

- Remove the battery compartment cover from the camera.

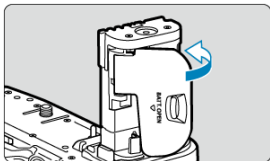
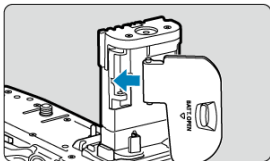

- Attach the cover to the battery grip.

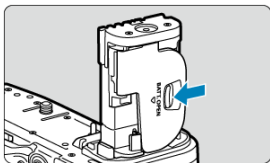

- To remove the cover, slide the lever to release it, following the attachment procedure in reverse.

3. Attach and lock the battery grip.

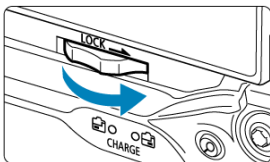
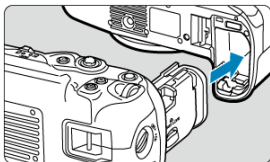

- Insert the battery grip contacts into the camera and turn the release dial to lock the battery grip in place.

4. Remove the battery magazine.

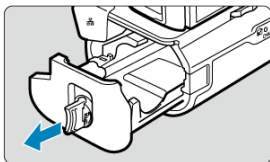
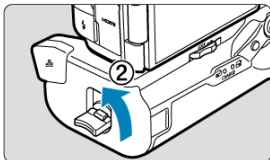
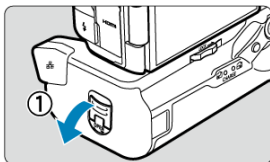

Caution

- Do not touch the camera or battery grip contacts.
- When reattaching the battery compartment cover to the camera, attach it opened to at least 90°.

1. Load the batteries.

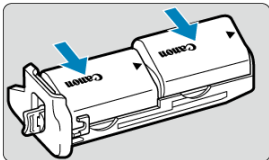

- Insert the batteries as shown.
- When only one battery is used, it can be inserted in either position.

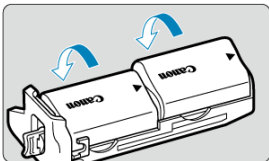

- To secure the batteries, push in the direction of the arrows until they click into place.

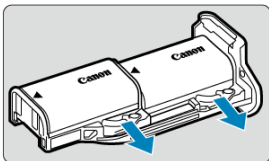

- To remove the batteries, press the battery magazine lever in the direction of the arrow.

2. Load the battery magazine.

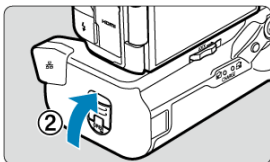
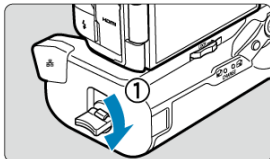
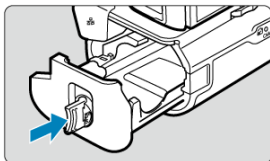

- Insert the battery magazine all the way in to secure it.

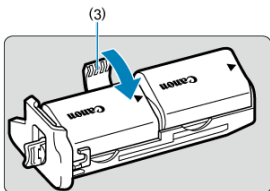

- The BG-R20EP battery magazine incorporates a battery holder (3). Open upward when loading batteries and close downward after the batteries are loaded.

 **Caution**

- When loading batteries, make sure the electrical contacts are clean. Wipe off any dirt on the contacts with a soft cloth.
- Load batteries after attaching the battery grip to the camera. If the battery grip is attached to the camera with batteries already loaded, it may prevent correct display of battery check results.
- Before removing the battery grip, turn the camera off and remove the batteries.
- Reattach the contact covers on the battery grip contacts after removing the battery grip. If the battery grip will not be used for some time, remove the batteries.
- Keep the product free of dirt, dust, water, or salt during storage.
- If a battery communication error message is displayed when a battery grip is attached, follow the instructions in the message. If the camera loses power, reinstall the battery magazine and restart the camera.
- If a battery communication error message is displayed, follow the instructions in the message, then turn off the camera and reattach the battery grip.

1. Attach the DC coupler.

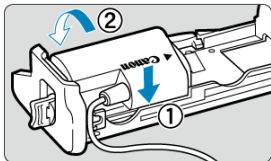

- Attach DC Coupler DR-E6P (sold separately) the same way as the batteries.

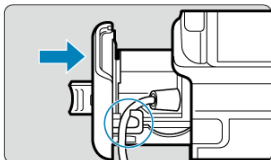

- Pass the DC coupler cord through the battery magazine cord groove.
- Insert the battery magazine all the way in to secure it.

2. Attach the battery magazine.

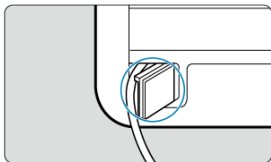

- Guide the end of the cord out of the cord hole.

3. Connect the DC coupler to the USB power adapter.

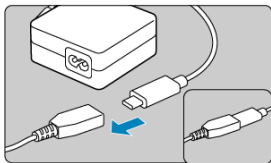

- Securely connect the DC coupler receptacle to the plug of USB Power Adapter PD-E2 (sold separately).

Note

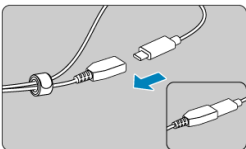

- To help prevent disconnection, use a cable tie to secure the cords of the DC coupler and USB power adapter as shown.

4. Connect the power cord.

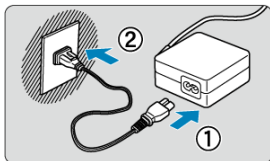

- Connect the power cord to the USB power adapter and plug the other end into a power outlet.

 **Caution**

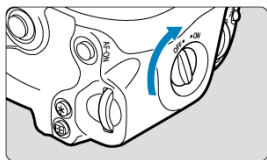

- While the camera is on, do not connect or disconnect the power cord or plug, and do not remove the battery magazine.
- Avoid getting the DC coupler cord caught between the battery grip and battery magazine.

Button and Dial Operations

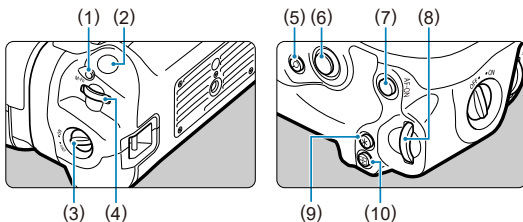

- To use the buttons and dials, turn the vertical-grip on/off switch (3) to ON.
- The buttons and dials are used the same way as corresponding buttons and dials on the camera.



-
- | | |
|------|---|
| (1) | < M-Fn > Multi-function button |
| (2) | Shutter button |
| (3) | Vertical-grip On/Off switch |
| (4) | <  > Main dial |
| (5) | < Q > Magnify/reduce button |
| (6) | < * > Multi-controller |
| (7) | < AF-ON > AF start button |
| (8) | <  > Quick control dial 2 |
| (9) | < * > AE lock/FE lock button |
| (10) | <  > AF point selection button |
-

Using a USB Power Adapter to Charge/Power the Camera

Using USB Power Adapter PD-E2 (sold separately), you can charge Battery Pack LP-E6P without removing it from the battery grip. The camera can also be powered.

Charging

1. Connect the USB power adapter.

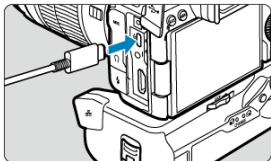

- With the camera power switch set to <OFF>, insert the USB power adapter plug fully into the camera <USB> terminal.

2. Charge the battery.

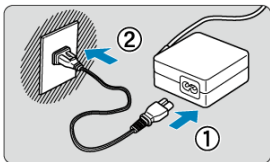

- Connect the power cord to the USB power adapter and plug the other end into a power outlet.

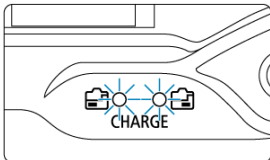

- Charging begins, and the battery grip charge lamp lights up.
- [⚡] is displayed on the camera LCD panel.
- When charging is finished, the charge lamp turns off.

Supplying power

To power the camera without charging batteries, set the camera power switch to <ON>. However, batteries are charged during auto power off.

The battery level indicator is gray when power is supplied.

To change from powering the camera to charging, set the camera power switch to <OFF>.

Caution

- The camera cannot be powered without a battery pack in the battery grip.
- Charging is not possible with LP-E6P loaded or DC Coupler DR-E6P connected.
- When batteries are depleted, the adapter charges them. In this case, power is not supplied to the camera.
- To protect the battery pack and keep it in optimal condition, do not charge it continuously for more than 24 hours.
- Charged batteries gradually lose their charge, even when they are not used.
- If the charging lamp fails to light up or a problem occurs during charging (shown by the charge lamp blinking), unplug the power cord, reinsert the battery, and wait a few minutes before plugging it in again. If the problem persists, take the camera to the nearest Canon Service Center.
- The charging time required and the amount charged vary depending on ambient temperature and remaining capacity.
- For safety, charging in low temperatures takes longer.
- The remaining battery level may decline when power is supplied to the camera. To avoid running out of battery power, use a fully charged battery.
- Before disconnecting USB power adapters, set the camera power switch to <OFF>.
- Some commercially available power adapters have been confirmed to charge and power the camera. For details, check the Canon website ([link](#)).
- You can also charge Battery Pack LP-E6NH/LP-E6N ([link](#)).

Note

- You can also charge a single LP-E6P battery at one time.

Using a Cooling Fan

- [Attaching to the Camera](#)
- [Loading Batteries](#)
- [Using a Household Power Outlet](#)
- [Setting Up a Cooling Fan](#)
- [Using a USB Power Adapter for Charging/Power](#)

Cooling Fan CF-R20EP (sold separately) is an accessory with a fan to cool the camera and a LAN terminal to add wired LAN functionality.

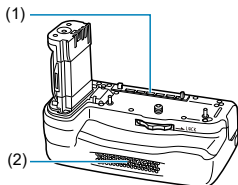

- (1) Air supply vent
(2) Intake vent
-

Attaching to the Camera

1. Remove the covers.

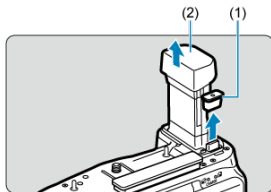

- Remove contact covers (1) and (2) on the cooling fan.

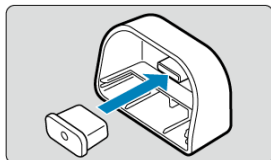

- Attach cooling fan contact cover (1) to (2) for storage.

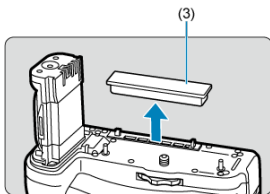

- Remove the dust cover (3) from the air supply vent and store it.

2. Remove the battery compartment cover.

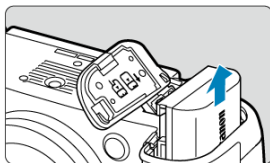

- Turn off the camera before removing the battery.

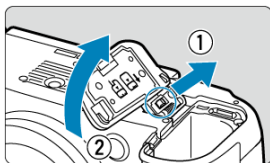

- Remove the battery compartment cover from the camera.

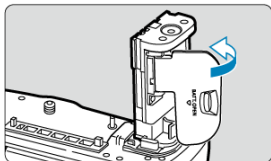
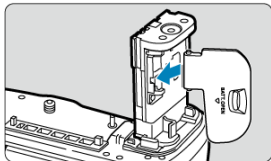

- Attach the cover you removed to the cooling fan.

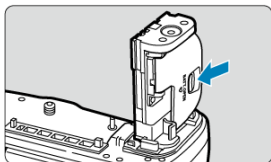

- To remove the cover, slide the lever to release it, following the attachment procedure in reverse.

3. Secure the cooling fan.

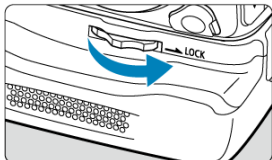
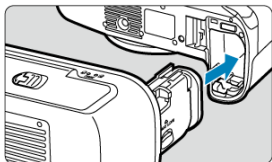

- Insert the contacts into the camera and turn the release dial to lock in place.

Caution

- Do not touch the camera or cooling fan contacts.
- When reattaching the battery compartment cover to the camera, attach it opened to at least 90°.

Loading Batteries

Load one or two LP-E6P batteries.

1. Open the battery compartment cover.

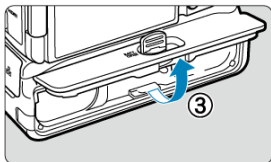
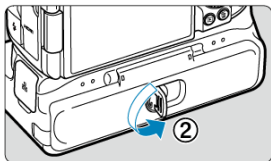
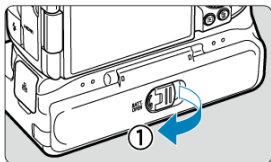

2. Load the batteries.

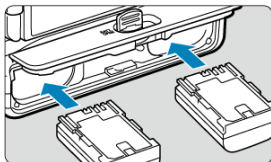

- Insert the batteries as shown.
- Push in until the batteries click into place.
- When only one battery is used, it can be inserted in either position.

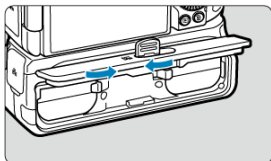

- To remove the batteries, press the release levers in the direction shown.

3. Close the battery compartment cover.

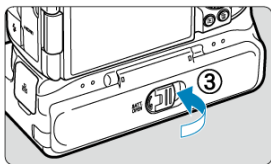
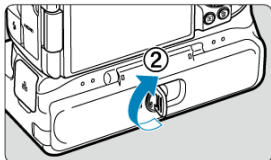
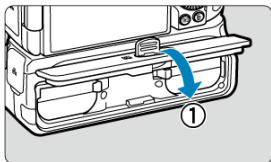

Caution

- When attaching batteries, make sure the electrical contacts are clean. Wipe off any dirt on the contacts with a soft cloth.
- Load batteries after attaching the cooling fan to the camera. If the cooling fan is attached to the camera with batteries already loaded, it may prevent correct display of battery check results.
- Before removing the cooling fan, turn the camera off and remove the batteries.
- After removing the cooling fan, attach the contact covers to the cooling fan contacts and the dust cover to the air supply vent. If the cooling fan will not be used for some time, remove the batteries.
- Keep the product free of dirt, dust, water, or salt during storage.
- If a battery communication error message is displayed when a cooling fan is attached, follow the instructions in the message. If the camera loses power, reinstall the batteries and restart the camera.

Using a Household Power Outlet

1. Attach the DC coupler.

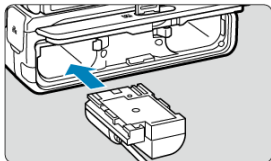

- Attach DC Coupler DR-E6P (sold separately) the same way that batteries are loaded.
- Only one DC coupler can be installed, in the position shown.

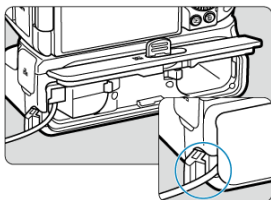

- Pass the DC coupler cord out of the cord hole.
- Close the battery compartment cover.

2. Connect the DC coupler to the USB power adapter.

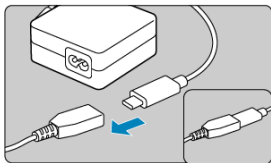

- Securely connect the DC coupler receptacle to the plug of USB Power Adapter PD-E2 (sold separately).

Note

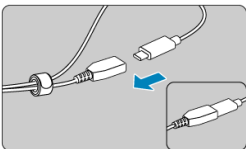

- To help prevent disconnection, use a cable tie to secure the cords of the DC coupler and USB power adapter as shown.

3. Connect the power cord.

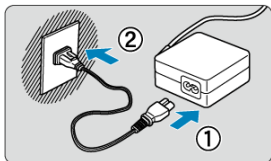

- Connect the power cord to the USB power adapter and plug the other end into a power outlet.

 **Caution**

- While the camera is on, do not connect or disconnect the power cord or plug, and do not remove batteries.

Setting Up a Cooling Fan

Setting up a cooling fan

- For setting details, see [Cooling Fan Settings](#).

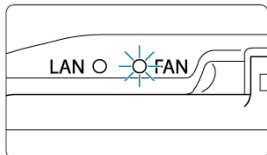

- The <FAN> indicator is lit when the cooling fan is in use.

! Caution

- Taking test shots in advance is recommended.
- While the cooling fan is on, warm air is discharged from the camera exhaust vent.
- Do not block the cooling fan intake vent or the camera exhaust vent with your hand or other objects while the cooling fan is in use.
- Fan noise may be included in movies that you record, in some shooting conditions. If so, it may help reduce these sounds if you use an external microphone and position it away from the cooling fan.
- The sound of the cooling fan operating at a different speed may be recorded when you start recording after standby, depending on the cooling fan settings.
- The cooling fan may not operate in cold conditions.
- Before recording, always confirm that the <FAN> indicator is lit.

Setting up a Network Connection

- For settings details, see [Communication Functions](#).

Using a USB Power Adapter for Charging/Power

Using USB Power Adapter PD-E2 (sold separately), you can charge Battery Pack LP-E6P without removing it from the cooling fan. The camera can also be powered.

Charging

1. Connect the USB power adapter.

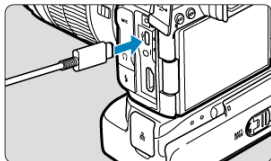

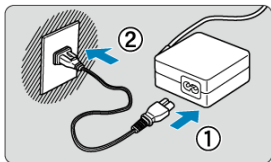

- With the camera power switch set to <OFF>, insert the USB power adapter plug fully into the camera <  > terminal.

2. Charge the battery.

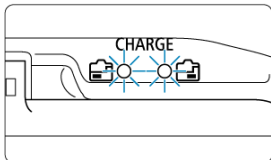

- Connect the power cord to the USB power adapter and plug the other end into a power outlet.



- Charging begins, and the cooling fan charge lamp is lit.
-  is displayed on the camera LCD panel.
- When charging is finished, the charge lamp turns off.

Supplying power

To power the camera without charging batteries, set the camera power switch to <ON>. However, batteries are charged during auto power off.

The battery level indicator is gray when power is supplied.

To change from powering the camera to charging, set the camera power switch to <OFF>.









Caution

- The camera cannot be powered without a battery pack in the cooling fan.
- Charging is not possible with LP-E6P loaded or DC Coupler DR-E6P connected.
- When batteries are depleted, the adapter charges them. In this case, power is not supplied to the camera.
- To protect the battery pack and keep it in optimal condition, do not charge it continuously for more than 24 hours.
- Charged batteries gradually lose their charge, even when they are not used.
- If the charging lamp fails to light up or a problem occurs during charging (shown by the charge lamp blinking), unplug the power cord, reinsert the battery, and wait a few minutes before plugging it in again. If the problem persists, take the camera to the nearest Canon Service Center.
- The charging time required and the amount charged vary depending on ambient temperature and remaining capacity.
- For safety, charging in low temperatures takes longer.
- The remaining battery level may decline when power is supplied to the camera. To avoid running out of battery power, use a fully charged battery.
- Before disconnecting USB power adapters, set the camera power switch to <OFF>.
- Some commercially available power adapters have been confirmed to charge and power the camera. For details, check the Canon website ([🌐](#)).
- You can also charge Battery Pack LP-E6NH/LP-E6N ([🌐](#)).

Note

- You can also charge a single LP-E6P battery at one time.

Troubleshooting Guide

-  [Power-related problems](#)
-  [Shooting-related problems](#)
-  [Communication problems](#)
-  [Operation problems](#)
-  [Display problems](#)
-  [Playback problems](#)
-  [Sensor cleaning problems](#)
-  [Computer connection problems](#)
-  [Problems with the multi-function shoe](#)

If a problem occurs with the camera, first refer to this Troubleshooting Guide. If this Troubleshooting Guide does not resolve the problem, take the camera to the nearest Canon Service Center.

Power-related problems

Batteries cannot be charged with the battery charger.

- If the battery's remaining capacity () is 94% or higher, the battery will not be charged.
- Do not use any battery packs other than a genuine Canon Battery Pack LP-E6P.
- In case of charging or charger issues, see [Charging the Battery](#).

The charger's lamp blinks at high speed.

- If (1) the battery charger or battery has a problem or (2) communication with the battery failed (with a non-Canon battery pack), the protection circuit will stop charging, and the charge lamp will blink in orange at a constant high speed. In the case of (1), unplug the charger's power plug from the power outlet, reattach the battery, wait a few minutes, and then reconnect the power plug to the power outlet. If the problem persists, take the camera to the nearest Canon Service Center.

The charger's lamp does not blink.

- For safety, hot or cold batteries inserted in the charger are not charged, and the lamp remains off. In this case, let the battery adjust to the ambient temperature before attempting to charge it again. During charging, if the battery's temperature becomes high for any reason, charging will stop automatically (lamp blinks). When the battery temperature goes down, charging will resume automatically.

Batteries cannot be charged with the USB power adapter (sold separately).

- Batteries are not charged while the camera power switch is set to < ON >. However, batteries are charged during auto power off.
- Batteries are not charged when their remaining capacity is already at least 94%.
- Operating the camera will stop charging in progress.

The access lamp blinks during charging with the USB power adapter.

- In case of charging problems, the access lamp blinks in green and a protective circuit stops charging. In this case, unplug the power cord, reattach the battery, and wait a few minutes before plugging it in again. If the problem persists, take the camera to the nearest Canon Service Center.
- If batteries are hot or cold, the access lamp blinks in green and a protective circuit stops charging. In this case, let the battery adjust to the ambient temperature before attempting to charge it again.

The access lamp is not lit during charging with the USB power adapter.

- Try unplugging the USB power adapter and plugging it in again.

The camera cannot be powered with the USB power adapter.

- Check the battery compartment. The camera cannot be powered without a battery pack.
- Check the remaining battery level. When batteries are depleted, the adapter charges them. In this case, power is not supplied to the camera.

The camera is not activated even when the power switch is set to < ON >.

- Make sure the battery is inserted properly in the camera (🔗).
- Make sure the card slot cover is closed (🔗).
- Charge the battery (🔗).

The access lamp still lights or blinks even when the power switch is set to <OFF>.

- If the power is turned off while an image is being recorded to the card, the access lamp will remain on or continue to blink for a few seconds. When the image recording is complete, the power will turn off automatically.

[Does this battery/do these batteries display the Canon logo?] is displayed.

- Do not use any battery packs other than a genuine Canon Battery Pack LP-E6P.
- Remove and install the battery again (🔧).
- If the electrical contacts are dirty, use a soft cloth to clean them.

The battery becomes exhausted quickly.

- Use a fully charged battery (🔋).
- The battery performance may have degraded. See [🔋: Battery info.] to check the battery recharge performance level (🔋). If the battery performance is poor, replace the battery with a new one.
- The number of available shots will decrease with any of the following operations:
 - Pressing the shutter button halfway for a prolonged period
 - Activating the AF frequently without taking a picture
 - Using the lens's Image Stabilizer
 - Using the wireless communication functions
 - Using accessories compatible with the multi-function shoe

The camera turns off by itself.

- Auto power off is in effect. To deactivate auto power off, set [Auto power off] in [🔋: Power saving] to [Disable] (🔧).
- Even if [Auto power off] is set to [Disable], the screen and viewfinder will still turn off after the camera is left idle for the time set in [Screen off] or [Viewfinder off] (although the camera itself remains on).

Shooting-related problems

The lens cannot be attached.

- To attach EF or EF-S lenses, you will need a mount adapter. The camera cannot be used with EF-M lenses (🔗).

Noise is audible from the camera when it is turned on.

- Drive noise may be audible from the camera.

No images can be shot or recorded.

- Make sure the card is properly inserted (🔗).
- Slide the card's write-protect switch to the Write/Erase setting (🔗).
- If the card is full, replace the card or delete unnecessary images to make space (🔗, 🔗).
- Shooting is not possible if the AF point turns orange when you attempt to focus. Press the shutter button halfway again to refocus automatically, or focus manually (🔗, 🔗).

The card cannot be used.

- If a card error message is displayed, see [Inserting/Removing Cards](#) and [Error Codes](#).

An error message is displayed when the card is inserted in another camera.

- Since SDXC cards are formatted in exFAT, if you format a card with this camera and then insert it into another camera, an error may be displayed and it may not be possible to use the card.

The image is out of focus or blurred.

- Set the lens's focus mode switch to < AF > (🔗). For lenses without a focus mode switch, set [AF: Focus mode] to [AF].
- Press the shutter button gently to prevent camera shake (🔗).
- With a lens equipped with an Image Stabilizer, set the Image Stabilizer switch to < ON >.
- In low light, the shutter speed may become slow. Use a faster shutter speed (🔗), set a higher ISO speed (🔗), use flash (🔗), or use a tripod.

I cannot lock the focus and recompose the shot.

- Set the AF operation to One-Shot AF (☑). Shooting with the focus locked is not possible with Servo AF (☑).

The continuous shooting speed is slow.

- High-speed continuous shooting may be slower depending on the battery level, ambient temperature, flickering light, shutter speed, aperture value, subject conditions, brightness, AF operation, type of lens, use of flash, shooting settings, and other conditions. For details, see [Selecting the Drive Mode](#), or see [File Size/Number of Shots Available and Maximum Burst](#) for still photos.





The maximum burst during continuous shooting is lower.

- Shooting intricate subjects such as fields of grass may result in larger file sizes, and the actual maximum burst may be lower than the guidelines in [File Size/Number of Shots Available and Maximum Burst](#) for still photos.

Even after I change the card, the maximum burst displayed for continuous shooting does not change.

- Estimated maximum burst indicated in the viewfinder does not change when you switch cards, even if you switch to a high-speed card. Maximum burst listed in [File Size/Number of Shots Available and Maximum Burst](#) for still photos is based on the standard Canon test card, and the actual maximum burst is higher for cards with faster writing speeds. For this reason, estimated maximum burst may differ from actual maximum burst.

Some image quality options are not available with cropped shooting.

-  /  /  /  image quality options are not available when [1.6x (crop)] is set, or with RF-S/EF-S lenses.

High-speed display is not available during high-speed continuous shooting.

- Refer to the high-speed display requirements in [High-Speed Display](#).

The aspect ratio cannot be set.

- Aspect ratios cannot be set for RF-S or EF-S lenses ([1.6x (crop)] is set automatically).
- Aspect ratios cannot be set when [: Add cropping information] is set to an option other than [Disable].

ISO 100 cannot be set for still photo shooting.

- The minimum speed in the ISO speed range is ISO 200 when [📷: Highlight tone priority] is set to [Enable] or [Enhanced].

Expanded ISO speeds cannot be selected for still photo shooting.

- Expanded ISO speeds are not available when [📷: Highlight tone priority] is set to [Enable] or [Enhanced].
- Expanded ISO speeds are not available when [📷: 📷 HDR shooting (PQ)] is set to [HDR PQ].
- Check the [ISO speed range] setting under [📷: 📷 ISO speed settings].

Even if I set a decreased exposure compensation, the image comes out bright.

- Set [📷: Auto Lighting Optimizer] to [Disable] (🔒). When [Low], [Standard], or [High] is set, even if you set a decreased exposure compensation or flash exposure compensation, the image may come out bright.

I cannot set the exposure compensation when both manual exposure and ISO Auto are set.

- See [M: Manual Exposure](#) to set the exposure compensation.

Not all the lens aberration correction options are displayed.

- With [Digital Lens Optimizer] set to [Standard] or [High], [Chromatic aberr corr] and [Diffraction correction] are not displayed, but they are both set to [Enable] for shooting.
- [Digital Lens Optimizer] is not displayed in movie recording.

Images are not displayed after shooting in multiple-exposure shooting.

- When [On:ContShtng] is set, images are not displayed for review after capture, and image playback is not available (🔒).

Using flash in [P] or [Av] mode lowers the shutter speed.

- Set [Slow synchro] in [📷: External Speedlite control] to [1/*-1/60sec. auto]^{*1} or [1/* sec. (fixed)]^{*1} (🔒).

* 1: The value of "1/*" varies depending on current settings.

The flash does not fire.

- Make sure any flash units are securely attached to the camera.

The flash always fires at full output.

- Flash units other than EL/EX series Speedlites used in autoflash mode always fire at full output (🔒).
- When [Flash metering mode] in [Flash C.Fn settings] for [📷: External Speedlite control] is set to [TTL flash metering] (autoflash), the flash always fires at full output (🔒).

Flash exposure compensation cannot be set.

- If flash exposure compensation is already set with the Speedlite, flash exposure compensation cannot be set with the camera. When the Speedlite's flash exposure compensation is canceled (set to 0), flash exposure compensation can be set with the camera.

High-speed sync is not available in [Fv] or [Av] mode.

- Set [Slow synchro] in [📷: External Speedlite control] to an option other than [1/* sec. (fixed)]*¹ (🔒).

* 1: The value of "1/*" varies depending on current settings.

Remote control shooting is not possible.

- Check the position of the remote control's release timing switch.
- If you are using Wireless Remote Control BR-E1, see [Remote Control Shooting](#) or [Connecting to a Wireless Remote Control](#).

A white [🔥] or red [🔥] icon is displayed during movie recording.

- Indicates that the camera's internal temperature is high. For details, see [Warning Indicator Display in Movie Recording](#).

The [📷: 📷] HDR shooting (PQ) setting changed to [Disable].

- The [📷: 📷] HDR shooting (PQ) setting is changed to [Disable] if the color depth (10 bit or 8 bit) of the main recording format set for time-lapse movies differs from the color depth of the main recording format set for normal movie recording when you record time-lapse movies after setting [📷: 📷] HDR shooting (PQ) to [HDR PQ].

Movie recording stops by itself.

- If the card's writing speed is slow, movie recording may stop automatically. For details on cards that can record movies, see [Estimated recording time, movie bit rate, file size, and card performance requirements](#). To find out the card's writing speed, refer to the card manufacturer's website, etc.
- Perform low-level formatting to initialize the card if the card's writing or reading speed seems slow (🔧).
- Movie recording stops automatically at 6 hr.
- In High Frame Rate movie recording, recording stops automatically at the following times.
 - Set to 119.88/100.00 fps: 1 hr. 30 min.
 - Set to 239.76/200.00 fps: 45 min.

The ISO speed cannot be set for movie recording.

- ISO speed is set automatically in [M] / [M] / [M] / [M] recording mode. In [M] mode, you can manually set the ISO speed (🔧).
- The minimum speed in the ISO speed range is ISO 200 when [📷: Highlight tone priority] is set to [Enable] or [Enhanced].

Expanded ISO speeds cannot be selected for movie recording.

- Check the [ISO speed range] setting under [📷: ISO speed settings].
- Expanded ISO speeds are not available when [📷: Highlight tone priority] is set to [Enable] or [Enhanced].

The exposure changes during movie recording.

- If you change the shutter speed or aperture value during movie recording, the changes in the exposure may be recorded.
- Recording a few test movies is recommended if you intend to perform zooming during movie recording. Zooming as you record movies may cause exposure changes or lens sounds to be recorded, or loss of focus.

The image flickers or horizontal stripes appear during movie recording.

- Flickering, horizontal stripes (noise), or irregular exposures can be caused by fluorescent lighting, LED lighting, or other light sources during movie recording. Also, changes in the exposure (brightness) or color tone may be recorded. In [M] mode, using a slower shutter speed may reduce the problem. The problem may be more noticeable in time-lapse movie recording.

The subject looks distorted during movie recording.

- If you move the camera to the left or right (panning) or shoot a moving subject, the image may look distorted. The problem may be more noticeable in time-lapse movie recording.

Sound is not recorded in movies.

- Sound is not recorded in High Frame Rate movies.

A time code is not added.

- Time codes are not added when you record High Frame Rate movies with **[Count up]** in **[CAMERA: Time code]** set to **[Free run]** (🔗).
- In movie recording, time codes can be added to HDMI video output by setting **[Time code]** to **[On]** in the **[HDMI]** setting for **[CAMERA: Time code]** (🔗).

Time codes advance faster than the actual time.

- Time codes in High Frame Rate movie recording advance as follows per second (🔗).
 - Set to 119.88/100.00 fps: 4 sec.
 - Set to 239.76/200.00 fps: 8 sec.

I cannot record movies during still photo shooting.

- It may not be possible to record movies during still photo shooting if operations such as extended image display increase the camera's internal temperature. Turn off the camera or take other measures, and wait until the camera cools down.
- Reducing the movie recording size may enable recording.

Cannot record movies.

- Format (initialize) the card with this camera (🔗).
- Recording to card 2 is not available with **[CAMERA: Main rec. format]** set to **[RAW]**.
- Two cards are required for movie recording when **[CAMERA: Dual shooting (still&movie)]** is set to **[On]**. Either set **[CAMERA: Dual shooting (still&movie)]** to **[Off]** or insert both card 1 and 2.

The camera vibrates.

- Image stabilization by the camera may make the camera seem to vibrate. This does not indicate damage.

The camera makes a sound when shaken.

- If you shake the camera with the power switch set to < **OFF** >, the Image Stabilizer system will shift and make a sound. This is not a malfunction.

Cannot pair with a smartphone.

- Use a smartphone compliant with Bluetooth Specification Version 4.1 or later.
- Turn on Bluetooth from the smartphone settings screen.
- Pairing with the camera is not possible from the smartphone's Bluetooth settings screen. Install the Camera Connect app (free of charge) on the smartphone (📲).
- Pairing with a previously paired smartphone is not possible if pairing information registered for another camera remains on the smartphone. In this case, remove the camera's registration retained in the Bluetooth settings on the smartphone and try pairing again (📲).

Wi-Fi functions cannot be set.

- If the camera is connected to a computer or another device with an interface cable, Wi-Fi functions cannot be set. Disconnect the interface cable before setting any functions (📲).

A device connected with an interface cable cannot be used.

- Other devices, such as computers, cannot be used with the camera by connecting them with an interface cable while the camera is connected to devices via Wi-Fi. Terminate the Wi-Fi connection before connecting the interface cable.

Operations such as shooting and playback are not possible.

- With a Wi-Fi connection established, operations such as shooting and playback may not be possible. Terminate the Wi-Fi connection, then perform the operation.

Cannot reconnect to a smartphone.



- Even with a combination of the same camera and smartphone, if you have changed the settings or selected a different setting, reconnection may not be established even after selecting the same SSID. In this case, delete the camera connection settings from the Wi-Fi settings on the smartphone and set up a connection again.
- A connection may not be established if the app you are connecting to is running when you reconfigure connection settings. In this case, quit the app for a moment and then restart it.

Operation problems



Settings change when I switch from still photo shooting to movie recording or vice versa.

- Separate settings are retained for use when shooting still photos and recording movies.





I cannot adjust settings with < >, < >, < >, < >, < >, or < >.

- Set the power/multi-function lock switch to < ON > to release the multi-function lock ().
- Check the [: Multi function lock] setting (.

Touch operation is not possible.

- Make sure [: Touch control] is set to [Standard] or [Sensitive] (.

A camera button or dial does not work as expected.

- Check settings on the [] tab (Control customization, .
- In movie recording, check the [: Shutter btn function for movies] setting (.

Display problems

The menu screen shows fewer tabs and items.

- Tabs and items on the menu screen vary for still photos and movies.
- In [A+] or [A] mode, some tabs and items are not displayed.

The display starts with [★] My Menu, or the [★] tab alone is displayed.

- [Menu display] on the [★] tab is set to [Display from My Menu tab] or [Display only My Menu tab]. Set [Normal display] (🔗).

The file name's first character is an underscore (“_”).

- Set [📷: Color space] to [sRGB]. If [Adobe RGB] is set, the first character will be an underscore (🔗).

The fourth character in the still photo file name changes.

- [Stills] in [📷: File name] is set to [*** + image size]. Select either the [Preset code] file name or the file name registered in [User setting1] (🔗).

The file numbering does not start from 0001.

- If the card already contains recorded images, the image number may not start from 0001 (🔗).

The shooting date and time displayed are incorrect.

- Make sure the correct date and time are set (🔗).
- Check the time zone and daylight saving time (🔗).

The date and time are not in the image.

- The shooting date and time do not appear in the image. The date and time are recorded in the image data as shooting information. When you print photos, this information can be used to include the date and time (🔗).

[###] is displayed.



- If the number of images recorded on the card exceeds the number the camera can display, [###] will be displayed.

The screen does not display a clear image.

- If the screen is dirty, use a soft cloth to clean it.
- The screen display may seem slightly slow in low temperatures or may look black in high temperatures. It will return to normal at room temperature.

Playback problems



Images are not displayed immediately.

- It may take a moment before images are displayed on the screen after you press the  button. It may help to set [Screen dimmer] in [: Power saving] to [Disable].

Part of the image blinks in black.

- [: Highlight alert] is set to [Enable] ().

A red box is displayed on the image.

- [: AF point disp.] is set to [Enable] ().

During image playback, the AF points are not displayed.

- AF points are not displayed when the following types of images are played back:
 - Cropped images



The image cannot be erased.

- If the image is protected, it cannot be erased ().

Still photos and movies cannot be played back.

- The camera may not be able to play back images taken with another camera.
- Movies edited with a computer cannot be played back with the camera.

Only few images can be played back.

- The images have been filtered for playback with [: Set image search conditions] (). Clear the image search conditions.

Mechanical sounds or sounds of camera operations can be heard during movie playback.

- The camera's built-in microphone may also record mechanical sounds of the lens or sounds of camera/lens operations if AF operations are performed or the camera or lens is operated during movie recording. In this case, using an external microphone may reduce these sounds. If the sounds are still distracting with an external microphone, it may be more effective to remove the external microphone from the camera and position it away from the camera and lens.

Movie playback stops by itself.

- Extended movie playback or movie playback under high ambient temperature may cause the camera's internal temperature to rise, and movie playback may stop automatically.
If this happens, playback is disabled until the camera's internal temperature decreases, so turn off the power and let the camera cool down a while.

The movie appears to freeze momentarily.

- Significant change in the exposure level during autoexposure movie recording may cause recording to stop momentarily until the brightness stabilizes. In this case, record in [iA/M] mode (🔗).

The movie is played in slow motion.

- Because high frame rate movies are recorded as 29.97/25.00 fps movies, they are played back as follows.
 - Set to 119.88/100.00 fps: Slow motion playback at 1/4 speed
 - Set to 239.76/200.00 fps: Slow motion playback at 1/8 speed

No picture appears on the television.

- Make sure [🔧: System frequency] is set to [59.94Hz:NTSC] or [50.00Hz:PAL] correctly for the video system of your television.
- Make sure the HDMI cable's plug is inserted all the way in (🔗).

My card reader does not recognize the card.

- Depending on the card reader used and the computer's operating system, SDXC cards may not be correctly recognized. In this case, connect the camera to the computer with the interface cable, then import the images to the computer using EOS Utility (EOS software, 🔗).



Images cannot be resized or cropped.

- This camera cannot resize JPEG **S2** images, RAW images, or frame-grab images from 8K or 4K movies saved as still photos (🔗).
- In-camera cropping is not available for RAW images, or for frame-grab images from 4K or 8K movies (🔗).

Dots of light appear on the image.

- White, red, or blue dots of light may appear in captured images if the sensor is affected by cosmic rays or similar factors. Their appearance may be reduced by performing **[Clean now, 🗑️]** under **[🔧: Sensor cleaning]** (🔗).

The shutter makes a sound during sensor cleaning.

- Although there is a mechanical sound from the shutter during cleaning after [**Clean now** , no image is recorded to the card ().

Automatic sensor cleaning does not work.

- Repeatedly turning the power switch < **ON** > and < **OFF** > within a short period may prevent the [, no image icon] from being displayed ().

Computer connection problems

I cannot import images to a computer.

- Install EOS Utility (EOS software) on the computer (🔗).
- Make sure the main EOS Utility window is displayed.
- Check the version of the application.

Communication between the connected camera and computer does not work.

- When using EOS Utility (EOS software), set [📷: Time-lapse movie] to [Disable] (🔗).

Problems with the multi-function shoe

A message was displayed on the screen when I attached an accessory.

- If [Communication error Reattach accessory] is displayed, reattach the accessory. In case this message is displayed again after reattachment, make sure the terminals of the multi-function shoe and accessory are clean and dry. If you cannot remove the dirt or moisture, contact a Canon Service Center.
- If [Accessory unavailable status] is displayed, check the terminals of the multi-function shoe and accessory and make sure the accessory is not damaged.

I cannot use USB on the camera while using Multi-Function Shoe Adapter for Smartphone Link AD-P1.

- The camera USB port is not available while Multi-Function Shoe Adapter for Smartphone Link AD-P1 is in use. To use the camera USB port, disconnect AD-P1.

Error Codes

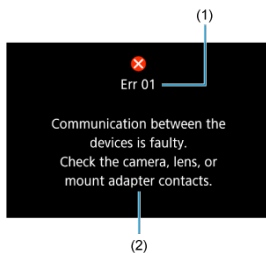

(1) Error number

(2) Cause and countermeasures

If there is a problem with the camera, an error message will appear. Follow the on-screen instructions.

If the problem persists, write down the error code (Err xx) and request service.

Information Display

- [LCD Panel](#)
- [Still Photo Shooting Screen](#)
- [Movie Recording Screen](#)
- [Scene Icons](#)
- [Playback Screen](#)

LCD Panel

Still photo/movie standby screen 1

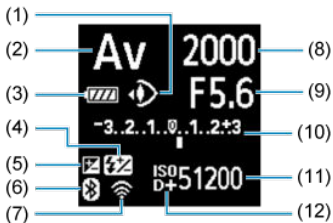

- | | |
|------|---|
| (1) | Eye control |
| (2) | Shooting mode |
| (3) | Battery level |
| (4) | Flash exposure compensation |
| (5) | Exposure compensation |
| (6) | Bluetooth function |
| (7) | Wi-Fi function/wired LAN |
| (8) | Shutter speed |
| (9) | Aperture value |
| (10) | Exposure level indicator (exposure compensation amount/AEB range) |
| (11) | ISO speed |
| (12) | Highlight tone priority |

Still photo standby screen 2

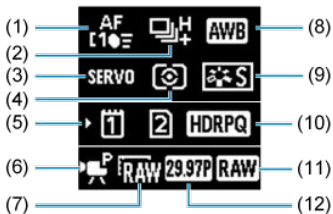

-
- (1) AF area
 - (2) Drive mode
 - (3) AF operation
 - (4) Metering mode
 - (5) Card slot
 - (6) Shooting mode (movies)
 - (7) Resolution (movies)
 - (8) White balance
 - (9) Picture Style/Custom Picture
 - (10) HDR shooting (PQ)
 - (11) RAW format (movies)
 - (12) Frame rate (movies)
-

Movie standby screen 2



-
- | | |
|-----|--------------------------------|
| (1) | AF area |
| (2) | Image Stabilizer (IS mode) |
| (3) | Card slot |
| (4) | White balance |
| (5) | Picture Style/Custom Picture |
| (6) | HDR shooting (PQ) |
| (7) | Movie recording time available |
-

Movie recording in progress

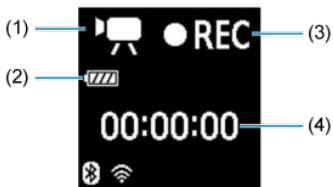

-
- (1) Shooting mode
-
- (2) Battery level
-
- (3) Recording in progress/External recording in progress (10-bit, via HDMI)
-
- (4) Elapsed recording time
-

Still Photo Shooting Screen

Each time you press the <INFO> button, the information display will change.

- The display will show only the settings currently applied.

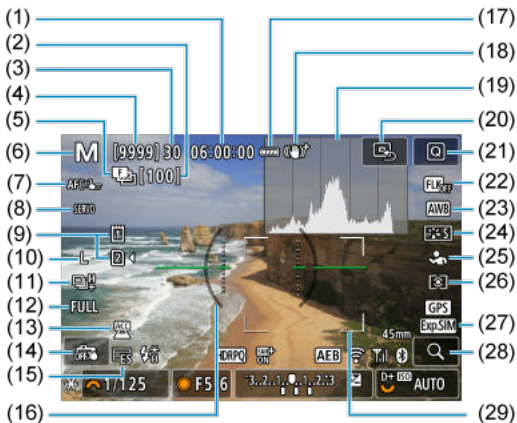

(1)	Movie recording time available
(2)	No. of remaining shots for focus bracketing, multiple exposures, or interval timer
(3)	Maximum burst
(4)	Number of available shots/Sec. until self-timer shoots
(5)	Focus bracketing/Multiple exposures/Bulb timer/Pre-continuous/Interval timer
(6)	Shooting mode
(7)	AF area
(8)	AF operation
(9)	Card
(10)	Image quality
(11)	Drive mode
(12)	Still photo cropping/Aspect ratio
(13)	Accessory attached indicator
(14)	Touch Shutter/Create folder
(15)	Electronic shutter
(16)	Electronic level
(17)	Battery level
(18)	Image Stabilizer (IS mode)
(19)	Histogram (Brightness/RGB)
(20)	Set AF point to center
(21)	Quick Control button
(22)	Anti-flicker shooting
(23)	White balance/White balance correction
(24)	Picture Style
(25)	Subject to detect
(26)	Metering mode
(27)	Display simulation/OVF sim. view assist
(28)	Magnify button
(29)	AF point (Flexible Zone AF 1)

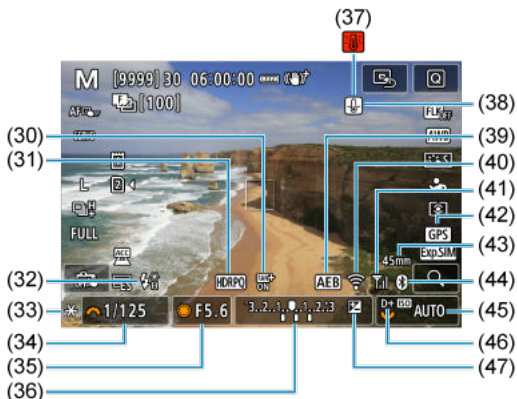

(30)	Cooling fan settings
(31)	HDR shooting (PQ)/View Assist
(32)	Flash ready/FE lock/High-speed sync
(33)	AE lock
(34)	Shutter speed/Multi-function lock warning
(35)	Aperture value
(36)	Exposure level indicator (exposure compensation amount/AEB range)
(37)	Overheating warning
(38)	Still photo image quality warning
(39)	AEB/FEB
(40)	Wi-Fi function/wired LAN
(41)	Wireless signal strength/Airplane mode
(42)	GPS connection status
(43)	Focal length
(44)	Bluetooth function
(45)	ISO speed
(46)	Highlight tone priority
(47)	Exposure compensation



Note

- You can specify the information displayed in response to pressing the < INFO > button (📄).
- The electronic level is not displayed when the camera is connected via HDMI to a television.
- Other icons may be displayed temporarily after setting adjustments.

Movie Recording Screen

Each time you press the <INFO> button, the information display will change.

- The display will show only the settings currently applied.

Standby



Movie recording in progress



- (1) Movie recording time available
- (2) Shooting mode
- (3) Card for recording/playback
- (4) Movie recording size
- (5) Headphone volume
- (6) Audio recording level (manual input)
- (7) Movie Servo AF
- (8) Movie self-timer
- (9) Overheat control
- (10) Image Stabilizer (Movie digital IS)
- (11) Movie shooting button (start recording)
- (12) HDR movie recording
- (13) Cooling fan settings
- (14) Exposure level indicator (metering levels)
- (15) Audio recording level indicator
- (16) Elapsed recording time
- (17) Recording status (left: main movie, right: proxy movie)
- (18) Movie recording in progress
- (19) Movie shooting button (stop recording)

* For simplicity, explanations are omitted for items also included in [Still Photo Shooting Screen](#), which are not shown here.

Caution

- You can specify the information displayed in response to pressing the <INFO> button ().
- The electronic level is not displayed when the camera is connected via HDMI to a television.
- The electronic level, grid lines, and histogram cannot be displayed during movie recording (and if they are currently displayed, recording a movie will clear the display).
- When movie recording starts, the movie recording remaining time will change to the elapsed time.

Note

- Other icons may be displayed temporarily after setting adjustments.

Scene Icons

In [A+] shooting mode or [A+] recording mode, the camera detects the type of scene and sets all settings accordingly. The detected scene type is indicated in the upper left of the screen.

Subject Background	People*1		Subjects Other Than People			Background Color
		In Motion*2	Nature/ Outdoor Scene	In Motion*2	Close*3	
Bright						Gray
Backlit						
Blue Sky Included						Light blue
Backlit						
Sunset	*4				*4	Orange
Spotlight						Dark blue
Dark						
With Tripod*1	*5*6	*4	*5*6	*4		

* 1: An icon for subjects other than people is displayed in time-lapse movie recording, even if people are detected.

* 2: Not displayed during movie recording.

* 3: Displayed when the attached lens has distance information. With an extension tube or close-up lens, the icon displayed may not match the actual scene.

* 4: Icons of scenes selected from those that can be detected are displayed.

* 5: Displayed when all the following conditions apply.

The shooting scene is dark, it is a night scene, and the camera is mounted on a tripod.

* 6: Displayed with any of the following lenses.

- EF300mm f/2.8L IS II USM
- EF400mm f/2.8L IS II USM
- EF500mm f/4L IS II USM
- EF600mm f/4L IS II USM
- Image Stabilizer lenses released in and after 2012.

* Slower shutter speeds are used when the conditions in both *5 and *6 apply.

Note

- For certain scenes or shooting conditions, the icon displayed may not match the actual scene.

Playback Screen

Each time you press the <INFO> button, the information display will change.

- The display will show only the settings currently applied.

Basic information display for still photos

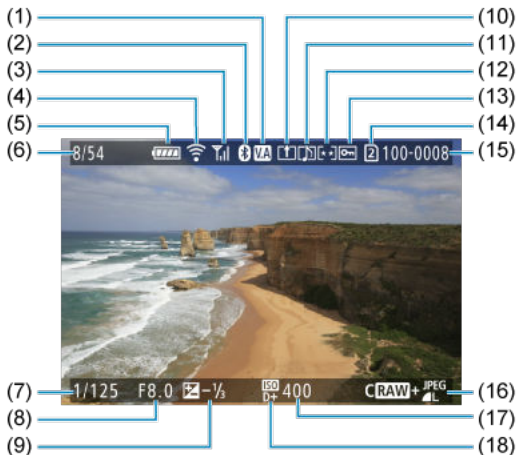

-
- (1) HDR View Assist
 - (2) Bluetooth function
 - (3) Wireless signal strength
 - (4) Wi-Fi function/wired LAN
 - (5) Battery level
 - (6) Current image no./Total images/No. of images found
 - (7) Shutter speed
 - (8) Aperture value
 - (9) Exposure compensation amount
 - (10) Already sent to a computer/smartphone
 - (11) Voice memo
 - (12) Rating
 - (13) Image protection
 - (14) Card no.
 - (15) Folder no.-File no.
 - (16) Image quality/Edited image/Cropping/Frame Grab
 - (17) ISO speed
 - (18) Highlight tone priority
-

 **Caution**

- If the image was taken by another camera, certain shooting information may not be displayed.
- It may not be possible to play back images taken with this camera on other cameras.

Detailed information display for still photos 1

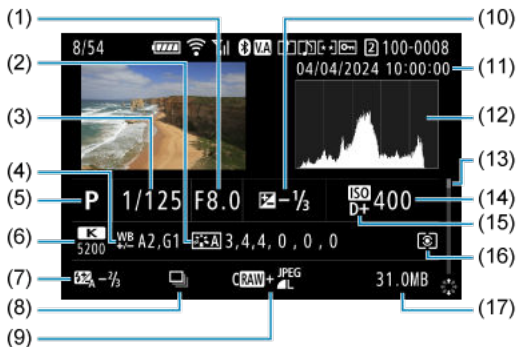

- | | |
|------|---|
| (1) | Aperture value |
| (2) | Picture Style (image characteristics/setting details) |
| (3) | Shutter speed |
| (4) | White balance correction/Bracketing |
| (5) | Shooting mode/Multiple exposure/Frame Grab |
| (6) | White balance |
| (7) | Flash exposure compensation amount/Bounce |
| (8) | First image of scene |
| (9) | Image quality/Edited image/Cropping |
| (10) | Exposure compensation amount |
| (11) | Shooting date and time |
| (12) | Histogram (Brightness/RGB) |
| (13) | Scroll bar |
| (14) | ISO speed |
| (15) | Highlight tone priority |
| (16) | Metering mode |
| (17) | File size |

* For simplicity, explanations are omitted for items also included in [Basic information display for still photos](#), which are not shown here.

* For images captured in RAW+JPEG/HEIF shooting, indicates RAW file sizes.

* Lines indicating the image area are displayed for images taken with the aspect ratio set (Ⓜ) and with RAW or RAW+JPEG set for image quality.

* Images with added cropping information are displayed cropped.

* During flash photography without flash exposure compensation, (⚡) will be displayed.

* (⚡) indicates images shot with bounce flash photography.

* (Ⓜ) indicates images captured in multiple-exposure shooting.

* (Ⓜ) indicates test shots for time-lapse movies.

*  indicates images created and saved by performing RAW image processing, resizing, cropping, HEIF to JPEG conversion, or frame-grabbing.

*  indicates images cropped and then saved.

* HEIF images that have been converted to JPEGs are labeled **[JPEG↓]**.

* Upscaled images are labeled .

Detailed information display for still photos 2

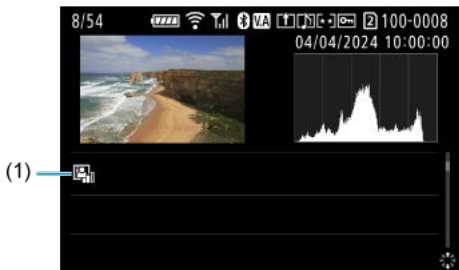

(1) Auto Lighting Optimizer

* For simplicity, explanations are omitted for items that are also included in [Basic information display for still photos](#) and [Detailed information display for still photos 1](#), which are not shown here.

Basic information display for movies



-
- | | |
|-----|-------------------------------|
| (1) | Movie playback |
| (2) | Movie orientation information |
| (3) | Reel and clip numbers |
| (4) | Recording time/Time code |
-

* For simplicity, explanations are omitted for items also included in [Basic information display for still photos](#), which are not shown here.

Detailed information display for movies 1

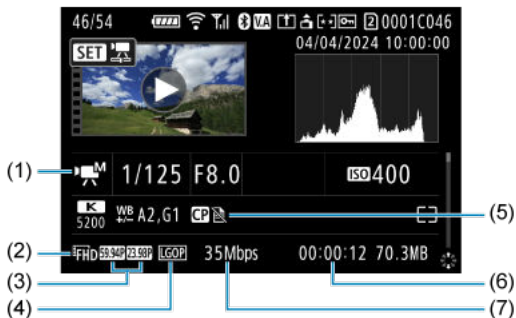

(1) Recording mode/High Frame Rate movie

(2) Movie recording size

(3) Frame rate (left: shooting, right: playback)

(4) Compression method

(5) Custom Picture/Picture Style (image characteristics/setting details)

(6) Recording time/Time code

(7) Bit rate

* For simplicity, explanations are omitted for items that are also included in [Basic information display for still photos](#), [Detailed information display for still photos 1](#), and [Basic information display for movies](#), which are not shown here.

* [H Av] indicates movies captured in High Frame Rate recording.

Note

- During movie playback, "**, **" is displayed for the [Fineness] and [Threshold] parameters of [Sharpness] in [📷: Picture Style].

Detailed information display for movies 2

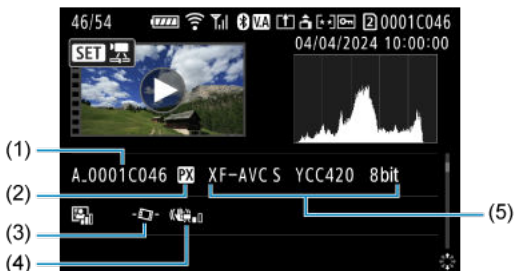

(1) Movie file name

(2) Proxy movie

(3) Movie auto level

(4) Image Stabilizer (Movie digital IS)

(5) Main movie recording format

* For simplicity, explanations are omitted for items that are also included in [Basic information display for still photos](#), [Detailed information display for still photos 1](#), [Detailed information display for still photos 2](#), [Basic information display for movies](#), and [Detailed information display for movies 1](#) which are not shown here.

Specifications

Type

Type: Digital single-lens non-reflex AF/AE camera

Lens mount: Canon RF mount

Compatible lenses: Canon RF lens group (including RF-S lenses)

* Canon EF or EF-S lenses (excluding EF-M lenses) also compatible, using Mount Adapter EF-EOS R

Lens focal length:

When using RF/EF lenses: Same as focal length indicated on the lens

When using RF-S/EF-S lenses: Approx. 1.6 times the focal length indicated on the lens

Image sensor

Type: Full-frame back-illuminated stacked CMOS sensor

Effective pixels*1*2	Max. approx. 45 megapixels
Total pixels*1	Approx. 50.3 megapixels
Screen size	Approx. 36.0×24.0 mm
Dual Pixel CMOS AF	Supported

* 1: Rounded to the nearest 100,000.

* 2: Using RF or EF lenses.

The effective pixel count may be lower with certain lenses and image processing.

Recording system

Image recording format: Compliant with Design rule for Camera File system 2.0 and Exif 2.31*1

* 1: Supports time difference information

Image type / recording format / extension

Image type / recording format		Extension
Still photo	JPEG	.JPG
	HEIF	.HIF
	RAW	.CR3
	C-RAW	
Movies	RAW	.CRM
	XF-HEVC S YCC422 10bit XF-HEVC S YCC420 10bit XF-AVC S YCC422 10bit XF-AVC S YCC420 8bit	.MP4
	News Metadata*1	.XML

* 1: When MP4 movie is recorded with [Add  File: On], ".CPF" file will be created.

Recording media

Recording media:

Card 1: CFexpress memory card

* Type B: Card slot

* CFexpress 2.0 and VPG400 supported

Card 2: SDXC/SDHC/SD memory card

* Compatible with UHS-II

Still photo recording

Recording pixel count

Image size		Resolution (Pixels)				
		Still photo cropping / aspect ratio				
		3:2	1.6x (crop) ^{*1}	1:1	4:3	16:9
JPEG / HEIF	L	Approx. 44.8 megapixels* ² (8192×5464)	Approx. 17.3 megapixels (5088×3392)	Approx. 29.8 megapixels (5456×5456)	Approx. 39.8 megapixels* ² (7280×5464)	Approx. 37.7 megapixels (8192×4608)
	M	24.0 megapixels (6000×4000)		16.0 megapixels (4000×4000)	Approx. 21.3 megapixels* ² (5328×4000)	Approx. 20.2 megapixels* ² (6000×3368)
	S1	Approx. 11.6 megapixels (4176×2784)		Approx. 7.8 megapixels (2784×2784)	Approx. 10.3 megapixels (3712×2784)	Approx. 9.8 megapixels* ² (4176×2344)
	S2	Approx. 3.8 megapixels (2400×1600)	Approx. 3.8 megapixels (2400×1600)	Approx. 2.6 megapixels (1600×1600)	Approx. 3.4 megapixels* ² (2112×1600)	Approx. 3.2 megapixels* ² (2400×1344)
RAW	RAW / C RAW	Approx. 44.8 megapixels* ² (8192×5464)	Approx. 17.3 megapixels (5088×3392)	Approx. 44.8 megapixels* ² (8192×5464)		

* Values for recorded pixels are rounded off to the nearest 100,000th.

* RAW/C-RAW images are generated in [3:2], and the set aspect ratio information is appended to the images.

* JPEG/HEIF images are generated in the set aspect ratio.

* These aspect ratios (M / S1 / S2) and pixel counts also apply to resizing.

* 1: Angle of view of approx. 1.6 times the indicated focal length.

* 2: Aspect ratios are slightly different for these image sizes.

Still photo file size / Number of shots available / Maximum burst for continuous shooting

Mechanical shutter / electronic first-curtain

Image quality		File size [Approx. MB]	Available shots [Approx.]* ¹	Maximum burst [Approx.]	
				CFexpress card* ¹	SD card* ²
JPEG* ³	L	13.0	23710	760	760
	M	7.8	39370	670	660
	S1	4.6	67580	670	660
	S2	1.8	171670	670	660
HEIF* ⁴	L	12.5	24290	690	640
	M	8.1	37350	740	740
	S1	4.9	60570	780	780
	S2	1.8	148190	790	780
RAW* ³	RAW	47.6	6540	230	95
	CRAW	20.6	15210	580	580
RAW+JPEG* ³	RAW +L	47.6 + 13.0	5120	150	87
	CRAW +L	20.6 + 13.0	9260	310	190
RAW+HEIF* ⁴	RAW +L	47.6 + 12.5	4860	89	84
	CRAW +L	20.6 + 12.5	8420	180	170

* 1: Number of shots available and maximum burst for CFexpress cards apply to 325 GB CFexpress cards conforming to Canon testing standards.

* 2: Maximum burst for SD cards applies to 128 GB UHS-II SD cards conforming to Canon testing standards.

* 3: When [ **HDR shooting (PQ): Disable**] is set.

* 4: When [ **HDR shooting (PQ): HDR PQ**] is set.

* Maximum burst as measured under conditions conforming to Canon testing standards (One-shot AF, High-speed continuous shooting+, JPEG/HEIF image quality: 8, ISO 100, Picture Style: Standard, and room temperature: 23°C / 73°F)

* File size, number of shots available, and maximum burst vary depending on shooting conditions (including remaining battery level, battery temperature, cropping/aspect ratio, JPEG/HEIF image quality, subject, memory card brand, ISO speed, Picture Style, and Custom Functions).

Electronic shutter

Image quality		File size [Approx. MB]	Available shots [Approx.]* ¹	Maximum burst [Approx.]							
				CFexpress card* ¹	SD card* ²						
JPEG* ³	L	See " Mechanical shutter / electronic first-curtain. "		200	200						
	M			200	200						
	S1			200	200						
	S2			200	200						
HEIF* ⁴	L			See " Mechanical shutter / electronic first-curtain. "		200	200				
	M					200	200				
	S1					200	200				
	S2					200	200				
RAW* ³	RAW					See " Mechanical shutter / electronic first-curtain. "		93	86		
	CRAW							170	170		
RAW+JPEG* ³	RAW+L							See " Mechanical shutter / electronic first-curtain. "		85	82
	CRAW+L									160	150
RAW+HEIF* ⁴	RAW+L	See " Mechanical shutter / electronic first-curtain. "								79	79
	CRAW+L									150	150

* 1: Number of shots available and maximum burst for CFexpress cards apply to 325 GB CFexpress cards conforming to Canon testing standards.

* 2: Maximum burst for SD cards applies to 128 GB UHS-II SD cards conforming to Canon testing standards.

* 3: When  **HDR shooting (PQ): Disable** is set.

* 4: When  **HDR shooting (PQ): HDR PQ** is set.

* Maximum burst as measured under conditions conforming to Canon testing standards (One-shot AF, High-speed continuous shooting+, JPEG/HEIF image quality: 8, ISO 100, Picture Style: Standard, and room temperature: 23°C / 73°F)

* File size, number of shots available, and maximum burst vary depending on shooting conditions (including remaining battery level, battery temperature, cropping/aspect ratio, JPEG/HEIF image quality, subject, memory card brand, ISO speed, Picture Style, and Custom Functions).

Movie recording



Main recording format

Main recording format	File extension
RAW	CRM
XF-HEVC S YCC422 10bit	MP4
XF-HEVC S YCC420 10bit	MP4
XF-AVC S YCC422 10bit	MP4
XF-AVC S YCC420 8bit	MP4

Proxy recording format

Proxy recording format	File extension
XF-HEVC S YCC420 10bit	MP4
XF-AVC S YCC420 8bit	MP4

* Set automatically depending on the main recording system.

* When [ **Rec options**] of [Record func+card/folder sel.] is set to [ Main  Proxy], proxy recording is possible.

Movie recording size

Main movie

Recording format	Compression method / RAW format	Resolution	Image quality	Frame rate (fps)					
				239.76	200.00	119.88	100.00	59.94	50.00
XF-HEVC S YCC422 10bit	High Quality Intra Standard Intra Light Intra Standard LGOP	8K-D	Normal						
		8K-U							
XF-HEVC S YCC420 10bit	Standard LGOP	8K-D	Normal						
		8K-U							
XF-HEVC S YCC422 10bit XF-HEVC S YCC420 10bit XF-AVC S YCC420 8bit	Standard LGOP	4K-D	Fine						
			Normal			Yes*1	Yes*1	Yes	Yes
		4K-U	Fine						
			Normal			Yes*1	Yes*1	Yes	Yes
		2K-D	Fine					Yes	Yes
			Normal	Yes*1	Yes*1	Yes*1	Yes*1	Yes	Yes
		Full HD	Fine					Yes	Yes
			Normal	Yes*1	Yes*1	Yes*1	Yes*1	Yes	Yes
XF-AVC S YCC422 10bit	High Quality Intra Standard Intra Light Intra Standard LGOP	4K-D	Fine						
			Normal			Yes*1*3	Yes*1*3	Yes	Yes
		4K-U	Fine						
			Normal			Yes*1*3	Yes*1*3	Yes	Yes
	Standard Intra Standard LGOP	2K-D	Fine					Yes	Yes
			Normal	Yes*1	Yes*1	Yes*1	Yes*1	Yes	Yes
		Full HD	Fine					Yes	Yes
			Normal	Yes*1	Yes*1	Yes*1	Yes*1	Yes	Yes

RAW ⁿ²	Standard RAW	RAW	—						
	Light RAW							Yes	Yes
	Standard RAW	SRAW	—					Yes	Yes
	Light RAW							Yes	Yes

Recording format	Compression method / RAW format	Resolution	Image quality	Frame rate (fps)			
				29.97	25.00	24.00	23.98
XF-HEVC S YCC422 10bit	High Quality Intra Standard Intra Light Intra Standard LGOP	8K-D	Normal	Yes*3	Yes*3	Yes	Yes
		8K-U		Yes*3	Yes*3		Yes
XF-HEVC S YCC420 10bit	Standard LGOP	8K-D	Normal	Yes	Yes	Yes	Yes
		8K-U		Yes	Yes		Yes
XF-HEVC S YCC422 10bit XF-HEVC S YCC420 10bit XF-AVC S YCC420 8bit	Standard LGOP	4K-D	Fine	Yes	Yes	Yes	Yes
			Normal	Yes	Yes	Yes	Yes
		4K-U	Fine	Yes	Yes		Yes
			Normal	Yes	Yes		Yes
		2K-D	Fine	Yes	Yes	Yes	Yes
			Normal	Yes	Yes	Yes	Yes
		Full HD	Fine	Yes	Yes		Yes
			Normal	Yes	Yes		Yes
XF-AVC S YCC422 10bit	High Quality Intra Standard Intra Light Intra Standard LGOP	4K-D	Fine	Yes	Yes	Yes	Yes
			Normal	Yes	Yes	Yes	Yes
		4K-U	Fine	Yes	Yes		Yes
			Normal	Yes	Yes		Yes
	Standard Intra Standard LGOP	2K-D	Fine	Yes	Yes	Yes	Yes
			Normal	Yes	Yes	Yes	Yes
		Full HD	Fine	Yes	Yes		Yes
			Normal	Yes	Yes		Yes
RAW*2	Standard RAW	RAW	—	Yes	Yes	Yes	Yes
	Light RAW			Yes	Yes	Yes	Yes
	Standard RAW	SRAW	—	Yes	Yes	Yes	Yes
	Light RAW			Yes	Yes	Yes	Yes

* 1: With [High Frame Rate: Disable] setting, movie is recorded with audio and the movie is played back at actual speed. With [High Frame Rate: Enable] setting, no audio is recorded and the movie is played in slow motion at 29.97 fps (NTSC) /25.00 fps (PAL) when played back. Only exFAT-formatted cards can be used for recording (recording to FAT32-formatted cards is not possible).

* 2: Recording is possible only when using an CFexpress card.

* 3: High Quality Intra cannot be selected.

Proxy movie

The recording format and movie recording size of the proxy movie are set automatically as shown in the table below depending on the recording format and movie recording size of the main movie.

Main recording format	Main movie recording size		Proxy recording format	Proxy movie recording size	
	Resolution	Compression format		Resolution	Compression format
RAW	RAW SRAW	Standard RAW Light RAW	XF-AVC S YCC420 8bit	2K-D	Standard LGOP Light LGOP
XF-HEVC S YCC422 10bit XF-HEVC S YCC420 10bit	4K-D 2K-D	Standard Intra Light Intra Standard LGOP	XF-HEVC S YCC420 10bit	2K-D	
	4K-U Full HD			Full HD	
XF-AVC S YCC422 10bit XF-AVC S YCC420 8bit	4K-D 2K-D	High Quality Intra Standard Intra Light Intra Standard LGOP	XF-AVC S YCC420 8bit	2K-D	
	4K-U Full HD			Full HD	

* The angle of view and frame rate of the proxy movie are the same as for the main movie.

* The image quality (Normal/Fine) of the proxy movie is fixed to Normal.

* When [1]Main [2]Proxy is set, a main movie of 100.00 fps or more is not possible.

* Even if recording of the proxy movie stops due to an error, recording of the main movie continues.

* If recording of the main movie stops, recording of the proxy movie also stops.

* When [1]Main [2]Proxy is set, the recording time of the main movie is indicated. When [Rec. to multiple] is set, the recording time for the card with the least space is indicated.

* If there is no card 1, the time available for recording of the proxy movie is indicated, and proxy movie recording is possible.

Recording format	Compression method / RAW format	Resolution	Image quality	Frame rate (fps)					
				239.76	200.00	119.88	100.00	59.94	50.00
XF-HEVC S YCC420 10bit XF-AVC S YCC420 8bit	Standard LGOP Light LGOP	2K-D	Normal					Yes	Yes
		Full HD						Yes	Yes

Recording format	Compression method / RAW format	Resolution	Image quality	Frame rate (fps)			
				29.97	25.00	24.00	23.98
XF-HEVC S YCC420 10bit XF-AVC S YCC420 8bit	Standard LGOP Light LGOP	2K-D	Normal	Yes	Yes	Yes	Yes
		Full HD		Yes	Yes		Yes

Built-in and external microphones

Built-in microphone: Monaural microphone

External microphone (External microphone IN terminal): 3.5 mm diameter stereo mini jack (3-pin)

Multi-function shoe input: Compatible with Directional Stereo Microphone DM-E1D

Estimated recording time, movie bit rate, file size, and card performance requirements

RAW, 8K-DCI Normal / 8K-UHD Normal

Recording format	Compression method / RAW type	Frame rate (fps)	Total recording time (approx.)			Video bit rate (Approx. Mbps)	File size (Approx. MB/min.)
			64 GB	256 GB	1 TB		
RAW	Standard RAW	29.97	3 min.	13 min.	51 min.	2600	18631
		25.00					
		24.00					
		23.98					
	Light RAW	59.94	3 min.	13 min.	51 min.	2600	18631
		50.00					
		29.97	5 min.	20 min.	1 hr. 19 min.	1670	11979
		25.00	6 min.	24 min.	1 hr. 34 min.	1400	10048
		24.00	6 min.	25 min.	1 hr. 39 min.	1340	9619
		23.98					

XF-HEVC S YCC422 10bit	High Quality Intra	24.00	4 min.	17 min.	1 hr. 9 min.	1920	13735	
		23.98						
	Standard Intra	29.97	4 min.	18 min.	1 hr. 14 min.	1800	12877	
		25.00	5 min.	22 min.	1 hr. 28 min.	1500	10731	
		24.00	5 min.	23 min.	1 hr. 32 min.	1440	10302	
		23.98						
	Light Intra	29.97	7 min.	28 min.	1 hr. 51 min.	1200	8585	
		25.00	8 min.	34 min.	2 hr. 13 min.	1000	7155	
		24.00	8 min.	35 min.	2 hr. 18 min.	960	6869	
		23.98						
	Standard LGOP	29.97	15 min.	1 hr. 3 min.	4 hr. 6 min.	540	3865	
		25.00						
		24.00						
		23.98						
	XF-HEVC S YCC420 10bit	Standard LGOP	29.97	21 min.	1 hr. 25 min.	5 hr. 33 min.	400	2863
			25.00					
24.00								
23.98								

* Video bit rate indicates video only; audio and metadata are not included.

* When [Audio format: AAC / 16bit / 2CH] is set (when set to RAW movie, LPCM / 24bit / 4CH).

* When [Add News Metadata: Off] is set.

* Movie recording stops when the maximum recording time per movie is reached.

* When set to UHD, 24.00 fps is not available.

RAW, 8K-DCI Normal / 8K-UHD Normal

Recording format	Compression method / RAW type	Frame rate (fps)	Card performance requirements	
			CFexpress card	SD card
RAW	Standard RAW	29.97	CFexpress 2.0 Type-B [400MB/sec. or faster]	—
		25.00		
		24.00		
		23.98		
	Light RAW	59.94	CFexpress 2.0 Type-B [400MB/sec. or faster]	
		50.00	CFexpress 2.0 Type-B [400MB/sec. or faster]	
		29.97	CFexpress 2.0 Type-B [400MB/sec. or faster]	
		25.00	CFexpress 2.0 Type-B [200MB/sec. or faster]	
		24.00	CFexpress 2.0 Type-B [200MB/sec. or faster]	
		23.98	CFexpress 2.0 Type-B [200MB/sec. or faster]	
XF-HEVC S YCC422 10bit	High Quality Intra	24.00	CFexpress 2.0 Type-B [400MB/sec. or faster]	
		23.98		
	Standard Intra	29.97	CFexpress 2.0 Type-B [400MB/sec. or faster]	
		25.00	CFexpress 2.0 Type-B [200MB/sec. or faster]	
		24.00	CFexpress 2.0 Type-B [200MB/sec. or faster]	
		23.98	CFexpress 2.0 Type-B [200MB/sec. or faster]	
	Light Intra	29.97	CFexpress 2.0 Type-B [200MB/sec. or faster]	
		25.00	CFexpress 2.0 Type-B [200MB/sec. or faster]	
		24.00	CFexpress 2.0 Type-B [200MB/sec. or faster]	
		23.98	CFexpress 2.0 Type-B [200MB/sec. or faster]	
	Standard LGOP	29.97	CFexpress 2.0	V90
		25.00		
		24.00		
		23.98		

XF-HEVC S YCC420 10bit	Standard LGOP	29.97	CFexpress 2.0	V60
		25.00		
		24.00		
		23.98		

SRAW, 4K-DCI Fine / 4K-UHD Fine

Recording format	Compression method / RAW type	Frame rate (fps)	Total recording time (approx.)			Video bit rate (Approx. Mbps)	File size (Approx. MB/min.)
			64 GB	256 GB	1 TB		
SRAW	Standard RAW	59.94	4 min.	18 min.	1 hr. 11 min.	1860	13338
		50.00	5 min.	21 min.	1 hr. 25 min.	1550	11121
		29.97	9 min.	36 min.	2 hr. 22 min.	930	6686
		25.00	10 min.	43 min.	2 hr. 49 min.	780	5613
		24.00	11 min.	45 min.	2 hr. 56 min.	750	5399
		23.98	11 min.	45 min.	2 hr. 59 min.	740	5327
	Light RAW	59.94	10 min.	40 min.	2 hr. 37 min.	840	6042
		50.00	12 min.	48 min.	3 hr. 9 min.	700	5041
		29.97	20 min.	1 hr. 20 min.	5 hr. 13 min.	420	3038
		25.00	24 min.	1 hr. 36 min.	6 hr. 15 min.	350	2538
		24.00	25 min.	1 hr. 41 min.	6 hr. 38 min.	330	2395
		23.98					
XF-HEVC S YCC422 10bit	Standard LGOP	29.97	1 hr. 3 min.	4 hr. 12 min.	16 hr. 25 min.	135	968
		25.00					
		24.00					
		23.98					
XF-HEVC S YCC420 10bit	Standard LGOP	29.97	1 hr. 25 min.	5 hr. 40 min.	22 hr. 9 min.	100	718
		25.00					
		24.00					
		23.98					

XF-AVC S YCC420 8bit	Standard LGOP	29.97	1 hr. 25 min.	5 hr. 40 min.	22 hr. 9 min.	100	718
		25.00					
		24.00					
		23.98					
XF-AVC S YCC422 10bit	High Quality Intra	29.97	14 min.	56 min.	3 hr. 42 min.	600	4294
		25.00	17 min.	1 hr. 8 min.	4 hr. 26 min.	500	3579
		24.00	17 min.	1 hr. 11 min.	4 hr. 37 min.	480	3436
		23.98					
	Standard Intra	29.97	18 min.	1 hr. 15 min.	4 hr. 56 min.	450	3221
		25.00	22 min.	1 hr. 30 min.	5 hr. 55 min.	375	2685
		24.00	23 min.	1 hr. 34 min.	6 hr. 10 min.	360	2577
		23.98					
	Light Intra	29.97	28 min.	1 hr. 53 min.	7 hr. 24 min.	300	2148
		25.00	34 min.	2 hr. 16 min.	8 hr. 52 min.	250	1791
		24.00	35 min.	2 hr. 22 min.	9 hr. 14 min.	240	1719
		23.98					
	Standard LGOP	29.97	56 min.	3 hr. 47 min.	14 hr. 47 min.	150	1075
		25.00					
		24.00					
		23.98					

* Video bit rate indicates video only; audio and metadata are not included.

* When [Audio format: AAC / 16bit / 2CH] is set (when set to RAW movie, LPCM / 24bit / 4CH).

* When [Add News Metadata: Off] is set.

* Movie recording stops when the maximum recording time per movie is reached.

* When set to UHD, 24.00 fps is not available.

SRAW, 4K-DCI Fine / 4K-UHD Fine

Recording format	Compression method / RAW type	Frame rate (fps)	Card performance requirements	
			CFexpress card	SD card
SRAW	Standard RAW	59.94	CFexpress 2.0 Type-B [400MB/sec. or faster]	—
		50.00	CFexpress 2.0 Type-B [200MB/sec. or faster]	
		29.97	CFexpress 2.0 Type-B [200MB/sec. or faster]	
		25.00	CFexpress 2.0	
		24.00	CFexpress 2.0	
		23.98	CFexpress 2.0	
	Light RAW	59.94	CFexpress 2.0 Type-B [200MB/sec. or faster]	
		50.00	CFexpress 2.0	
		29.97	CFexpress 2.0	
		25.00	CFexpress 2.0	
		24.00	CFexpress 2.0	
		23.98		
XF-HEVC S YCC422 10bit	Standard LGOP	29.97	CFexpress 2.0	U3
		25.00		
		24.00		
		23.98		

XF-HEVC S YCC420 10bit	Standard LGOP	29.97	CFexpress 2.0	U3
		25.00		
		24.00		
		23.98		
XF-AVC S YCC420 8bit	Standard LGOP	29.97	CFexpress 2.0	U3
		25.00		
		24.00		
		23.98		
XF-AVC S YCC422 10bit	High Quality Intra	29.97	CFexpress 2.0	V90
		25.00	CFexpress 2.0	V90
		24.00	CFexpress 2.0	V60
		23.98		
	Standard Intra	29.97	CFexpress 2.0	V60
		25.00	CFexpress 2.0	V60
		24.00	CFexpress 2.0	V60
		23.98		
	Light Intra	29.97	CFexpress 2.0	V60
		25.00	CFexpress 2.0	V60
		24.00	CFexpress 2.0	U3
		23.98		
	Standard LGOP	29.97	CFexpress 2.0	U3
		25.00		
		24.00		
		23.98		

4K-DCI Normal / 4K-UHD Normal

Recording format	Compression method	Frame rate (fps)	Total recording time (approx.)			Video bit rate (Approx. Mbps)	File size (Approx. MB/min.)
			64 GB	256 GB	1 TB		
XF-HEVC S YCC422 10bit	Standard LGOP	119.88	18 min.	1 hr. 15 min.	4 hr. 56 min.	450	3221
		100.00					
		59.94	37 min.	2 hr. 31 min.	9 hr. 51 min.	225	1612
		50.00					
		29.97	1 hr. 3 min.	4 hr. 12 min.	16 hr. 25 min.	135	968
		25.00					
		24.00					
		23.98					
XF-HEVC S YCC420 10bit	Standard LGOP	119.88	28 min.	1 hr. 53 min.	7 hr. 24 min.	300	2148
		100.00					
		59.94	56 min.	3 hr. 47 min.	14 hr. 47 min.	150	1075
		50.00					
		29.97	1 hr. 25 min.	5 hr. 40 min.	22 hr. 9 min.	100	718
		25.00					
		24.00					
		23.98					
XF-AVC S YCC420 8bit	Standard LGOP	119.88	28 min.	1 hr. 53 min.	7 hr. 24 min.	300	2148
		100.00					
		59.94	56 min.	3 hr. 47 min.	14 hr. 47 min.	150	1075
		50.00					
		29.97	1 hr. 25 min.	5 hr. 40 min.	22 hr. 9 min.	100	718
		25.00					
		24.00					
		23.98					

XF-AVC S
YCC422
10bit

High Quality Intra	59.94	7 min.	28 min.	1 hr. 51 min.	1200	8585
	50.00	8 min.	34 min.	2 hr. 13 min.	1000	7155
	29.97	14 min.	56 min.	3 hr. 42 min.	600	4294
	25.00	17 min.	1 hr. 8 min.	4 hr. 26 min.	500	3579
	24.00	17 min.	1 hr. 11 min.	4 hr. 37 min.	480	3436
	23.98					
Standard Intra	119.88	4 min.	18 min.	1 hr. 14 min.	1800	12877
	100.00	5 min.	22 min.	1 hr. 28 min.	1500	10731
	59.94	9 min.	37 min.	2 hr. 28 min.	900	6440
	50.00	11 min.	45 min.	2 hr. 57 min.	750	5367
	29.97	18 min.	1 hr. 15 min.	4 hr. 56 min.	450	3221
	25.00	22 min.	1 hr. 30 min.	5 hr. 55 min.	375	2685
	24.00	23 min.	1 hr. 34 min.	6 hr. 10 min.	360	2577
	23.98					
Light Intra	119.88	7 min.	28 min.	1 hr. 51 min.	1200	8585
	100.00	8 min.	34 min.	2 hr. 13 min.	1000	7155
	59.94	14 min.	56 min.	3 hr. 42 min.	600	4294
	50.00	17 min.	1 hr. 8 min.	4 hr. 26 min.	500	3579
	29.97	28 min.	1 hr. 53 min.	7 hr. 24 min.	300	2148
	25.00	34 min.	2 hr. 16 min.	8 hr. 52 min.	250	1791
	24.00	35 min.	2 hr. 22 min.	9 hr. 14 min.	240	1719
	23.98					

Standard LGOP	119.88	17 min.	1 hr. 8 min.	4 hr. 26 min.	500	3579
	100.00					
	59.94	34 min.	2 hr. 16 min.	8 hr. 52 min.	250	1791
	50.00					
	29.97	56 min.	3 hr. 47 min.	14 hr. 47 min.	150	1075
	25.00					
	24.00					
	23.98					

* Video bit rate indicates video only; audio and metadata are not included.

* When **[Audio format: AAC / 16bit / 2CH]** is set.

* When **[Add News Metadata: Off]** is set.

* Movie recording stops when the maximum recording time per movie is reached.

* Same applies when **[Movie cropping: Enable]** is set.

* When set to UHD, 24.00 fps is not available.

4K-DCI Normal / 4K-UHD Normal

Recording format	Compression method	Frame rate (fps)	Card performance requirements	
			CFexpress card	SD card
XF-HEVC S YCC422 10bit	Standard LGOP	119.88	CFexpress 2.0	V60
		100.00		
		59.94	CFexpress 2.0	V60
		50.00		
		29.97	CFexpress 2.0	U3
		25.00		
		24.00		
		23.98		
XF-HEVC S YCC420 10bit	Standard LGOP	119.88	CFexpress 2.0	V60
		100.00		
		59.94	CFexpress 2.0	U3
		50.00		
		29.97	CFexpress 2.0	U3
		25.00		
		24.00		
		23.98		
XF-AVC S YCC420 8bit	Standard LGOP	119.88	CFexpress 2.0	V60
		100.00		
		59.94	CFexpress 2.0	U3
		50.00		
		29.97	CFexpress 2.0	U3
		25.00		
		24.00		
		23.98		

XF-AVC S YCC422
10bit

XF-AVC S YCC422 10bit	High Quality Intra	59.94	CFexpress 2.0	—
		50.00	CFexpress 2.0	—
		29.97	CFexpress 2.0	V90
		25.00	CFexpress 2.0	V90
		24.00	CFexpress 2.0	V60
		23.98		
	Standard Intra	119.88	CFexpress 2.0 Type-B [400MB/sec. or faster]	—
		100.00	CFexpress 2.0 Type-B [200MB/sec. or faster]	—
		59.94	CFexpress 2.0 Type-B [200MB/sec. or faster]	—
		50.00	CFexpress 2.0	—
		29.97	CFexpress 2.0	V60
		25.00	CFexpress 2.0	V60
		24.00	CFexpress 2.0	V60
		23.98		
	Light Intra	119.88	CFexpress 2.0	—
		100.00	CFexpress 2.0	—
		59.94	CFexpress 2.0	V90
		50.00	CFexpress 2.0	V90
		29.97	CFexpress 2.0	V60
		25.00	CFexpress 2.0	V60
		24.00	CFexpress 2.0	U3
		23.98		

Standard LGOP	119.88	CFexpress 2.0	V90
	100.00		
	59.94	CFexpress 2.0	V60
	50.00		
	29.97	CFexpress 2.0	U3
	25.00		
	24.00		
	23.98		

2K-DCI Fine / Full HD Fine

Recording format	Compression method	Frame rate (fps)	Total recording time (approx.)			Video bit rate (Approx. Mbps)	File size (Approx. MB/min.)
			64 GB	256 GB	1 TB		
XF-HEVC S YCC422 10bit	Standard LGOP	59.94	2 hr. 49 min.	11 hr. 19 min.	44 hr. 12 min.	50	360
		50.00					
		29.97					
		25.00					
		24.00					
		23.98					
XF-HEVC S YCC420 10bit	Standard LGOP	59.94	4 hr. 2 min.	16 hr. 7 min.	63 hr. 1 min.	35	253
		50.00					
		29.97					
		25.00					
		24.00					
		23.98					
XF-AVC S YCC420 8bit	Standard LGOP	59.94	4 hr. 2 min.	16 hr. 7 min.	63 hr. 1 min.	35	253
		50.00					
		29.97					
		25.00					
		24.00					
		23.98					

XF-AVC S YCC422 10bit	Standard Intra	59.94	28 min.	1 hr. 53 min.	7 hr. 24 min.	300	2148
		50.00	34 min.	2 hr. 16 min.	8 hr. 52 min.	250	1791
		29.97	56 min.	3 hr. 47 min.	14 hr. 47 min.	150	1075
		25.00	1 hr. 8 min.	4 hr. 32 min.	17 hr. 44 min.	125	896
		24.00	1 hr. 10 min.	4 hr. 43 min.	18 hr. 28 min.	120	861
		23.98					
	Standard LGOP	59.94	2 hr. 49 min.	11 hr. 19 min.	44 hr. 12 min.	50	360
		50.00					
		29.97					
		25.00					
		24.00					
		23.98					

* Video bit rate indicates video only; audio and metadata are not included.

* When [Audio format: AAC / 16bit / 2CH] is set.

* When [Add News Metadata: Off] is set.

* Movie recording stops when the maximum recording time per movie is reached.

* When set to Full HD, 24.00 fps is not available.

2K-DCI Fine / Full HD Fine

Recording format	Compression method	Frame rate (fps)	Card performance requirements	
			CFexpress card	SD card
XF-HEVC S YCC422 10bit	Standard LGOP	59.94	CFexpress 2.0	U3
		50.00		
		29.97		
		25.00		
		24.00		
		23.98		
XF-HEVC S YCC420 10bit	Standard LGOP	59.94	CFexpress 2.0	U3
		50.00		
		29.97		
		25.00		
		24.00		
		23.98		
XF-AVC S YCC420 8bit	Standard LGOP	59.94	CFexpress 2.0	U3
		50.00		
		29.97		
		25.00		
		24.00		
		23.98		

XF-AVC S YCC422 10bit	Standard Intra	59.94	CFexpress 2.0	V60
		50.00	CFexpress 2.0	V60
		29.97	CFexpress 2.0	U3
		25.00	CFexpress 2.0	U3
		24.00	CFexpress 2.0	U3
		23.98		
	Standard LGOP	59.94	CFexpress 2.0	U3
		50.00		
		29.97		
		25.00		
		24.00		
		23.98		

2K-DCI Normal / Full HD Normal

Recording format	Compression method	Frame rate (fps)	Total recording time (approx.)			Video bit rate (Approx. Mbps)	File size (Approx. MB/min.)
			64 GB	256 GB	1 TB		
XF-HEVC S YCC422 10bit	Standard LGOP	239.76	42 min.	2 hr. 50 min.	11 hr. 5 min.	200	1433
		200.00					
		119.88	1 hr. 25 min.	5 hr. 40 min.	22 hr. 9 min.	100	718
		100.00					
		59.94	2 hr. 49 min.	11 hr. 19 min.	44 hr. 12 min.	50	360
		50.00					
		29.97					
		25.00					
		24.00					
		23.98					
XF-HEVC S YCC420 10bit XF-AVC S YCC420 8bit	Standard LGOP	239.76	1 hr.	4 hr. 3 min.	15 hr. 50 min.	140	1004
		200.00					
		119.88	2 hr. 1 min.	8 hr. 5 min.	31 hr. 37 min.	70	503
		100.00					
		59.94	4 hr. 2 min.	16 hr. 7 min.	63 hr. 1 min.	35	253
		50.00					
		29.97					
		25.00					
		24.00					
		23.98					

XF-AVC S YCC422 10bit	Standard Intra	239.76	7 min.	28 min.	1 hr. 51 min.	1200	8585
		200.00	8 min.	34 min.	2 hr. 13 min.	1000	7155
		119.88	14 min.	56 min.	3 hr. 42 min.	600	4294
		100.00	17 min.	1 hr. 8 min.	4 hr. 26 min.	500	3579
		59.94	28 min.	1 hr. 53 min.	7 hr. 24 min.	300	2148
		50.00	34 min.	2 hr. 16 min.	8 hr. 52 min.	250	1791
		29.97	56 min.	3 hr. 47 min.	14 hr. 47 min.	150	1075
		25.00	1 hr. 8 min.	4 hr. 32 min.	17 hr. 44 min.	125	896
		24.00	1 hr. 10 min.	4 hr. 43 min.	18 hr. 28 min.	120	861
		23.98					
	Standard LGOP	239.76	42 min.	2 hr. 50 min.	11 hr. 5 min.	200	1433
		200.00					
		119.88	1 hr. 25 min.	5 hr. 40 min.	22 hr. 9 min.	100	718
		100.00					
		59.94	2 hr. 49 min.	11 hr. 19 min.	44 hr. 12 min.	50	360
		50.00					
		29.97					
		25.00					
		24.00					
23.98							

* Video bit rate indicates video only; audio and metadata are not included.

* When [Audio format: AAC / 16bit / 2CH] is set.

* When [Add News Metadata: Off] is set.

* Movie recording stops when the maximum recording time per movie is reached.

* Same applies when [Movie cropping: Enable] is set.

* When set to Full HD, 24.00 fps is not available.

2K-DCI Normal / Full HD Normal

Recording format	Compression method	Frame rate (fps)	Card performance requirements	
			CFexpress card	SD card
XF-HEVC S YCC422 10bit	Standard LGOP	239.76	CFexpress 2.0	U3
		200.00		
		119.88	CFexpress 2.0	U3
		100.00		
		59.94	CFexpress 2.0	U3
		50.00		
		29.97		
		25.00		
		24.00		
		23.98		
XF-HEVC S YCC420 10bit XF-AVC S YCC420 8bit	Standard LGOP	239.76	CFexpress 2.0	U3
		200.00		
		119.88	CFexpress 2.0	U3
		100.00		
		59.94	CFexpress 2.0	U3
		50.00		
		29.97		
		25.00		
		24.00		
		23.98		

XF-AVC S YCC422 10bit	Standard Intra	239.76	CFexpress 2.0 Type-B [200MB/sec. or faster]	—
		200.00	CFexpress 2.0 Type-B [200MB/sec. or faster]	—
		119.88	CFexpress 2.0	V90
		100.00	CFexpress 2.0	V90
		59.94	CFexpress 2.0	V60
		50.00	CFexpress 2.0	V60
		29.97	CFexpress 2.0	U3
		25.00	CFexpress 2.0	U3
		24.00	CFexpress 2.0	U3
		23.98		
	Standard LGOP	239.76	CFexpress 2.0	U3
		200.00		
		119.88	CFexpress 2.0	U3
		100.00		
		59.94	CFexpress 2.0	U3
		50.00		
		29.97		
		25.00		
		24.00		
		23.98		

Proxy movie (2K-DCI Normal / Full HD Normal)

Recording format	Compression method	Frame rate (fps)	Total recording time (approx.)			Video bit rate (Approx. Mbps)	File size (Approx. MB/min.)
			64 GB	256 GB	1 TB		
XF-HEVC S YCC420 10bit XF-AVC S YCC420 8bit	Standard LGOP	59.94	8 hr. 44 min.	34 hr. 58 min.	136 hr. 39 min.	16	117
		50.00					
		29.97					
		25.00					
		24.00					
		23.98					
	Light LGOP	59.94	15 hr. 21 min.	61 hr. 25 min.	239 hr. 55 min.	9	67
		50.00					
		29.97					
		25.00					
		24.00					
		23.98					

* Video bit rate indicates video only; audio and metadata are not included.

* When [Audio format: AAC / 16bit / 2CH] is set.

* When [Add News Metadata: Off] is set.

* Movie recording stops when the maximum recording time per movie is reached.

* When set to Full HD, 24.00 fps is not available.

Proxy movie (2K-DCI Normal / Full HD Normal)

Recording format	Compression method	Frame rate (fps)	Card performance requirements	
			CFexpress card	SD card
XF-HEVC S YCC420 10bit XF-AVC S YCC420 8bit	Standard LGOP	59.94	CFexpress 2.0	U3
		50.00		
		29.97		
		25.00		
		24.00		
		23.98		
	Light LGOP	59.94	CFexpress 2.0	U3
		50.00		
		29.97		
		25.00		
		24.00		
		23.98		

Autofocus (AF)

Focusing method: Dual Pixel CMOS AF

Focusing brightness range

Still photo shooting

EV -6.5 to 21 (with an f/1.2 lens,* center AF point, One-Shot AF at room temperature, and ISO 100)

* Except RF lenses with a Defocus Smoothing (DS) coating

Movie recording

- 8K30p: EV -4.5 to 21
- 4K30p: EV -3.5 to 21
- Full HD30p: EV -4.0 to 21
(with an f/1.2 lens,* center AF point, One-Shot AF at room temperature, ISO 100, and 29.97 / 25.00 fps.)
* Except RF lenses with a Defocus Smoothing (DS) coating

Focusing operation

	Still photo shooting	Movie recording
AF operation	<ul style="list-style-type: none">• One-Shot AF• AI Focus AF• Servo AF	<ul style="list-style-type: none">• One-Shot AF• Movie Servo AF
Manual focus (MF)	Supported	Supported

* When set to AI Focus AF, the camera automatically switches from One-Shot AF to Servo AF in response to subject movement (also applies during continuous shooting).

* Automatically set to [AI Focus AF] in [A+] mode.

Focus mode: AF / MF

* Applies when an RF or RF-S lens without a focus mode switch is used.

* When lenses with a focus mode switch are used, the setting on the lens takes precedence.

Lens compatibility based on AF area: Refer to the Canon website ([🌐](#)).

Number of AF area available for automatic selection

Focusing area		Horizontal: Approx. 100%, Vertical: Approx. 100%
Number of AF zones	Still photos	Max. 1053 zones (39×27)
	Movies	Max. 975 zones (39×25)

* May vary depending on settings.

Selectable positions for AF point

Focusing area		Horizontal: Approx. 90%, Vertical: Approx. 100%
Numbers of positions	Still photos	Max. 5850 positions (90×65)
	Movies	Max. 4500 positions (90×50)

* When set to [1-point AF] and selected using the Multi-controller.

* Values for the selectable positions for AF points do not represent AF performance.

Eye control

This feature is for still photo shooting.

Detection method: Line-of-sight detection using corneal reflections (Purkinje images) acquired using infrared LEDs and an image of the user's pupil

Viewfinder

Type: OLED color electronic viewfinder

Screen size: Approx. 1.3 cm (0.5 inch)

Dot count: Approx. 5,760,000 dots

Magnification / Angle of view: Approx. 0.76x / Approx. 35.5° (at an aspect ratio of 3:2 and with a 50 mm lens at infinity, -1 m^{-1})

Coverage: Approx. 100% (at L image size, an aspect ratio of 3:2, and approx. 24 mm eyepoint)

Eyepoint: Approx. 24 mm (at -1 m^{-1} from eyepiece lens end)

Dioptric adjustment: Approx. -4.0 to $+2.0\text{ m}^{-1}$ (dpt)

Screen

Type: TFT color LCD screen

Screen size: Approx. 8.0 cm (3.2 inch) (aspect ratio of 3:2)

Dot count: Approx. 2,100,000 dots

Angle of view: Approx. 170° vertically and horizontally

Coverage: Approx. 100% vertically and horizontally (at L image size and an aspect ratio of 3:2)

Screen brightness: Manually adjustable in a range of 1–7

Touch-screen: Capacitive sensing

LCD panel

Type: Reflective memory LCD

Display format: Dot-matrix display

Dot count: 128 × 128 dots

HDMI output

Output terminal: HDMI output terminal (Type A)

* HDMI CEC not supported

HDMI resolution: Auto / 1080p / 1080i

Exposure control

Metering functions under various shooting conditions

Item		Still photo shooting	Movie recording
Metering sensor		Based on the image sensor output signals	
		6144-zone (96×64) metering*1	DCI: 4800-zone (96×50) metering*1 UHD: 5184-zone (96×54) metering*1
Metering mode	Evaluative metering	Yes	Yes
	Partial metering	Yes * Approx. 9.5% in the center of the screen*3	
	Spot metering*2	Yes * Approx. 5.3% in the center of the screen*3	
	Center-weighted average	Yes	—
Metering brightness range (at room temperature, ISO 100)		EV -3 to 20	EV -1 to 20

* 1: Same applies when [1.6x (crop)] or [Movie cropping: Enable] is set.

* 2: Multi-spot metering not available (not supported).

* 3: When set to Full-frame. Values differ for 1.6x (crop).

ISO speed (recommended exposure index) in still photo shooting

Manual ISO speed setting for still photos

	ISO speed
Normal ISO speed	ISO 100–51200
Expanded ISO speed	L (equivalent to ISO 50), H (equivalent to ISO 102400)

* When set to **[Highlight tone priority]**, the available manual setting range is ISO 200–51200.

* Expanded ISO speeds are not available when **[HDR shooting (PQ): HDR PQ]** is set.

Manual ISO speed setting range for still photos

ISO speed range	ISO speed
Minimum	L (equivalent to ISO 50) to ISO 51200
Maximum	ISO 100 to H (equivalent to ISO 102400)

ISO Auto setting range for still photos

Auto range	ISO speed
Minimum	ISO 100–25600
Maximum	ISO 200–51200

ISO Auto details for still photos

Shooting mode	No flash	Using flash	
		Variable control of maximum ISO Auto limit for E-TTL	
		Compatible lens	Incompatible lens
[A] ¹	ISO 100–12800	ISO 100–6400	ISO 100–1600
Fv / P / Av / M / Tv	ISO 100 ¹⁺² –51200 ²	ISO 100 ¹⁺² –6400 ²	ISO 100 ¹⁺² –1600 ²
BULB	ISO 400 ³	ISO 400 ³	

* 1: ISO 200 when set to **[Highlight tone priority: Enable/Enhanced]**.

* 2: Varies depending on the **[Maximum]** and **[Minimum]** settings for **[Auto range]**.

* 3: If outside the setting range, changed to the value most close to ISO 400.

Variable control of maximum ISO Auto limit for E-TTL: Supported

ISO speed (recommended exposure index) in movie recording

Manual ISO speed setting for movies (in M mode)

	Custom Picture	ISO speed
Normal ISO speed	Off*1*2	ISO 100–25600
	Canon 709 / PQ / HLG	ISO 400–25600
	Canon Log 2 / Canon Log 3	ISO 800–25600
	BT.709 Standard	ISO 160–25600
Expanded ISO speed	Off*3*4*5*6	H (equivalent to ISO 32000, 40000, or 51200)
	Canon 709 / PQ / HLG*6	L (equivalent to ISO 100, 125, 160, 200, 250, or 320) H (equivalent to ISO 32000, 40000, or 51200)
	Canon Log 2 / Canon Log 3*6	L (equivalent to ISO 100, 125, 160, 200, 250, 320, 400, 500, or 640) H (equivalent to ISO 32000, 40000, or 51200)
	BT.709 Standard*6	L (equivalent to ISO 100 or 125) H (equivalent to ISO 32000, 40000, or 51200)

* 1: The lower end of the ISO speed range starts from ISO 200 when [Highlight tone priority] is set.

* 2: Settable ISO speeds are ISO 800 – ISO 12800 when [HDMI] HDR Movie Mode: Enable is set.

* 3: Expanded ISO speeds are not available when [PQ] HDR shooting (PQ): HDR PQ is set.

* 4: Expanded ISO speeds are not available when [HDMI] HDR Movie Mode: Enable is set.

* 5: Expanded ISO speeds are not available when [Highlight tone priority] is set.

* 6: Expanded ISO speeds are not available in RAW movie recording.

* Maximum ISO speed when set manually corresponds to the [ISO speed range] setting.

Automatic ISO speed setting for movies (in P / Tv / Av mode, and in M mode with ISO Auto)

	Custom Picture	ISO speed
Normal ISO speed	Off*1*2	ISO 100–25600
	Canon 709 / PQ / HLG	ISO 400–25600
	Canon Log 2 / Canon Log 3	ISO 800–25600
	BT.709 Standard	ISO 160–25600
Expanded ISO speed	Off*3*4*5*6	H (equivalent to ISO 32000/40000/51200)
	Canon 709 / PQ / HLG*6	
	Canon Log 2 / Canon Log 3*6	
	BT.709 Standard*6	

* 1: The lower end of the ISO speed range starts from ISO 200 when [Highlight tone priority] is set.

* 2: Settable ISO speeds are ISO 800 – ISO 12800 when [HDMI]HDMI Movie Mode: Enable] is set.

* 3: Expanded ISO speeds are not available when [HDMI]HDMI shooting (PQ): HDR PQ] is set.

* 4: Expanded ISO speeds are not available when [HDMI]HDMI Movie Mode: Enable] is set.

* 5: Expanded ISO speeds are not available when [Highlight tone priority] is set.

* 6: Expanded ISO speeds are not available in RAW movie recording.

* Maximum ISO speed when set automatically corresponds to the [Max for Auto] setting.

Manual ISO speed setting range for movies

ISO speed range	ISO speed
Minimum	ISO 100–25600
Maximum	ISO 200–25600, H (equivalent to ISO 51200)

Maximum ISO Auto setting for movies

	ISO speed
Max for Auto	ISO 6400–25600, H (equivalent to ISO 51200)

Maximum ISO auto setting for time-lapse movies

	ISO speed
Max for Auto	ISO 400–25600

Shutter

Still photo shooting

Type:

Electronically controlled focal-plane shutter

Rolling shutter, using the image sensor

Shutter mode

Shutter mode	Flash photography
Mechanical shutter	Possible
Electronic 1st-curtain	Possible
Electronic shutter	Possible

Shutter speed

Shutter mode	Setting range
Mechanical shutter	1/8000–30 sec., bulb
Electronic 1st-curtain	
Electronic shutter*1	1/32000*2–30 sec., bulb

* 1: Shutter speeds of 1/10000 sec. or faster are only available in Tv or M mode (up to 1/8000 sec. in Fv, P, or Av mode).

* 2: When [ISO speed/Shutter speed] or [Shutter speed] is set with Focus bracketing, Flash photography, or [Same expo. for new aperture], the maximum shutter speed limit will be 1/8000 sec.

Flash sync speed

Shutter mode	Flash sync speed		
	EL/EX Speedlite		Non-Canon flash unit
	Full-frame	1.6x (crop)	
Mechanical shutter	1/200 sec.	1/250 sec.	1/200 sec.
Electronic 1st-curtain	1/250 sec.	1/320 sec.	1/250 sec.
Electronic shutter	1/160 sec.	1/250 sec.	1/160 sec.

Movie recording

Type: Rolling shutter, using the image sensor

Shutter speed: 1/8000*¹–1/25*²⁺³ sec.

Movies in Tv or M mode: 1/8000*¹–1/8*²⁺³ sec.

* 1: Maximum of 1/4000 sec. in time-lapse movie shooting.

* 2: In normal movie recording, the minimum speed varies depending on the recording mode and frame rate.



* 3: The minimum speed is 1/250 sec. (NTSC) / 1/200 sec. (PAL) when the frame rate is set to 239.76 or 200.00 fps, and 1/125 sec. (NTSC) / 1/100 sec. (PAL) when the frame rate is set to 119.88 or 100.00 fps.

Image stabilization (IS mode): Provided

Drive

Drive mode and continuous shooting speed

[Max. approx.]

Drive mode	AF operation	Icon display	Mechanical shutter	Electronic 1st-curtain	Electronic shutter
Single shooting			Yes	Yes	Yes
High-speed continuous shooting+ 	One-Shot AF AI Focus AF Servo AF	Green	12 shots/sec.	12 shots/sec.	30 shots/sec.
		White	9.0 shots/sec.	9.0 shots/sec.	
		White (Blinking)	7.2 shots/sec.	7.2 shots/sec.	
High-speed continuous shooting 	One-Shot AF AI Focus AF Servo AF	Green	6.0 shots/sec.	8.2 shots/sec.	15 shots/sec.
		White	5.2 shots/sec.	6.6 shots/sec.	
		White (Blinking)	4.0 shots/sec.	5.1 shots/sec.	
Low-speed continuous shooting 	One-Shot AF AI Focus AF Servo AF	Green	3.0 shots/sec.	3.0 shots/sec.	5.0 shots/sec.
		White	3.0 shots/sec.	3.0 shots/sec.	
		White (Blinking)	3.0 shots/sec.	3.0 shots/sec.	
Self-timer: 10 sec.			Yes	Yes	Yes
Self-timer: 2 sec.			Yes	Yes	Yes
Self-timer: Continuous			Yes	Yes	Yes

External flash

Accessory shoe contacts: 21 pins for accessories compatible with the multi-function shoe, 5 pins for X-sync and communication

Sync terminal: Provided

Flash exposure compensation: ±3 stops (in 1/3- or 1/2-stop increments)

Playback

Item	Still photos	Movies
AF point display	Yes	
Playback grid	Off / 3×3 / 6×4 / 3×3+diag	
Magnified view	1.5×–10× (15 levels)	
Set image search conditions	Search conditions Rating / Date / Folder / Protect / Type of file (1) / Type of file (2)	
Rating	OFF / ★ to ★★★★★ Select images / Select range / All images in folder / All images on card / All found images	
Protect images	Select images / Select range / All images in folder / Unprotect all images in folder / All images on card / Unprotect all images on card / All found images / Unprotect all found images	
In-camera RAW image processing	Yes	
Resizing	Yes	
Cropping	Yes	

VR preview

Supported images:

- Still photos
Recording format: JPEG, RAW, and C-RAW
Image size: L size
- Movies
Recording format: No restrictions
Movie recording size
Resolution: 8K-D
Frame rate: 59.94 / 50.00*, 29.97 / 25.00 , 24.00, or 23.98 fps
* Played back with 29.97 fps / 25.00 fps.
Compression: No restrictions

VR image display specifications:

Resolution: Maximum output resolution when HDMI is Full HD 1920×1080.

Frame rate: 59.94 / 50.00*, 29.97 / 25.00 , 24.00, or 23.98 fps

* Played back with 29.97 fps / 25.00 fps.

Frame grab from movies

Individual frames in 8K / 4K movies recorded with the camera can be saved as still photos (JPEG / HEIF).

8K	DCI	Approx. 35.4 megapixels (8192×4320)
	UHD	Approx. 33.2 megapixels (7680×4320)
4K	DCI	Approx. 8.8 megapixels (4096×2160)
	UHD	Approx. 8.3 megapixels (3840×2160)

* Still photos are saved as JPEGs from normal movies, and as HEIF images from HDR PQ movies.

* Frame grabbing from RAW movies is not available.

* In-camera resizing or cropping and in-camera upscaling are not available for frame-grabbed still photos.

* The camera cannot frame grab still photos from movies recorded when **[CF] function: On** is set.

Print order (DPOF)

Compliant with DPOF Version 1.1

External interface

Digital terminal

Terminal type	USB Type-C™
Transmission	Equivalent to USB 10 Gbps (SuperSpeed Plus USB / USB 3.2 Gen 2)
Applications	<ul style="list-style-type: none">• For computer communication / smartphone communication• USB battery charging / camera power supply

HDMI output terminal: HDMI terminal (Type A)

* Resolution switches automatically

* HDMI CEC not supported

External microphone IN terminal: 3.5 mm diameter stereo mini jack (3-pin)

Headphone terminal: 3.5 mm diameter stereo mini jack

Remote control terminal: N3 type terminal

Power source

Battery

Compatible battery packs	LP-E6P
Quantity used	1

* LP-E6NH/LP-E6N can also be used but functionality is limited (🔒).

* LP-E6 cannot be used.

USB battery charging and camera power supply: Using USB Power Adapter PD-E2

AC power source

DC Coupler DR-E6P, USB Power Adapter PD-E2

Number of shots available

Shooting method	Temperature	Available shots (approx.)	
		Power saving* ¹	Smooth* ²
Viewfinder shooting* ³	+23°C / 73°F	340	250
On-screen shooting* ⁴		630	540

* 1: Based on CIPA standards.

* 2: According to Canon measurement conditions, which are based on CIPA standards.

* 3: When set to **[Viewfinder]**.

* 4: When set to **[Screen]**.

* With a new, fully charged LP-E6P

* The number of shots available may vary greatly depending on the shooting environment.

* Fewer shots may be available with a compatible accessory attached to the multifunction shoe, because the camera powers the accessory.

* LP-E6NH/LP-E6N can also be used, but fewer shots are available.

* Using two LP-E6P batteries with Battery Grip BG-R20 approximately doubles the number of shots available, compared to the table above.

* Using two LP-E6P with Cooling Fan CF-R20EP and not using the cooling fan and wired LAN function approximately doubles the number of shots available, compared to the table above.

* Using two LP-E6P with Battery Grip BG-R20EP and not using the wired LAN function approximately doubles the number of shots available, compared to the table above.

Available operating time

Conditions of use			Temperature	Available operating time
Time available for bulb exposure			+23°C / 73°F	Approx. 4 hr. 10 min.
Time available for Live View shooting			+23°C / 73°F	Approx. 4 hr.
Time available for movie recording* ¹	8K RAW	<ul style="list-style-type: none"> • Light RAW • 59.94 / 50.00 fps 	+23°C / 73°F	Approx. 50 min.
			0°C / 32°F	Approx. 50 min.
	8K DCI	<ul style="list-style-type: none"> • Standard LGOP • 29.97 / 25.00 fps 	+23°C / 73°F	Approx. 1 hr.
	4K DCI	<ul style="list-style-type: none"> • Standard LGOP • 59.94 / 50.00 fps 	+23°C / 73°F	Approx. 1 hr. 20 min.
			0°C / 32°F	Approx. 1 hr. 10 min.
	Full HD	<ul style="list-style-type: none"> • Standard LGOP • 29.97 / 25.00 fps 	+23°C / 73°F	Approx. 2 hr. 10 min.
			0°C / 32°F	Approx. 2 hr.
Time available for movie playback (normal playback)	4K DCI	<ul style="list-style-type: none"> • Standard LGOP • 59.94 / 50.00 fps 	+23°C / 73°F	Approx. 2 hr. 40 min.

* When using a new, fully charged LP-E6P

* When using the screen

* 1: When [Movie Servo AF: Disable] and [Movie cropping: Disable] are set

Dimensions and weight

Dimensions

(W) × (H) × (D)	Approx. 138.5×101.2×93.5 mm / Approx. 5.45×3.98×3.68 in.
-----------------	--

* Based on CIPA guidelines.

Weight

Body (including battery and CFexpress card) * Based on CIPA guidelines.	Approx. 746 g / Approx. 26.31 oz.
Body only	Approx. 656 g / Approx. 23.14 oz.

* Not including body cap or shoe cover.

Operating environment

Operating temperature: 0–40°C / 32–104°F

Operating humidity: 85% or less

Wi-Fi (wireless LAN)

Supported standards (equivalent to IEEE 802.11b/g/n/a/ac/ax standards)

Wi-Fi standards (equivalent)	Transmission method	RU Type	Maximum link speed	
			5GHz band / 6GHz band	2.4 GHz band
IEEE 802.11ax 2×2 MIMO	OFDM modulation (OFDMA)	996-tone	1201 Mbps	—
		484-tone	574 Mbps	—
		242-tone	229 Mbps	229 Mbps
		106-tone	100 Mbps	100 Mbps
		52-tone	47 Mbps	47 Mbps
		26-tone	24 Mbps	24 Mbps
IEEE 802.11ax		996-tone	601 Mbps	—
		484-tone	287 Mbps	—
		242-tone	115 Mbps	115 Mbps
		106-tone	50 Mbps	50 Mbps
		52-tone	24 Mbps	24 Mbps
		26-tone	12 Mbps	12 Mbps
IEEE 802.11ax 2×2 MIMO	OFDM modulation (CSMA/CA)	—	1201 Mbps	287 Mbps
IEEE 802.11ax			601 Mbps	143 Mbps
IEEE 802.11ac 2×2 MIMO			867 Mbps	—
IEEE 802.11ac			433 Mbps	—
IEEE 802.11n 2×2 MIMO			300 Mbps	144 Mbps
IEEE 802.11n			150 Mbps	72 Mbps
IEEE 802.11a			54 Mbps	—
IEEE 802.11g			—	54 Mbps
IEEE 802.11b	DSSS modulation	—	—	11 Mbps

* Compatible with MIMO (multiple-input and multiple-output) 2×2

Transmission frequency (Center frequency)

2.4 GHz band

Frequency	2412 to 2462 MHz
Channels	1 to 11 ch

5 GHz band

Frequency	5180 to 5825 MHz
Channels	36 to 165 ch

* Specifications vary by country/region.

6 GHz band

Frequency	5955 to 7045 MHz
Channels	1 to 229 ch

* Specifications vary by country/region.

Authentication and data encryption methods

2.4 GHz band / 5 GHz band

Connection method	Authentication	Encryption
Camera access point	Open	Disable
	WPA2 / WPA3-Personal	AES
Infrastructure	Open	Disable
	Enhanced Open	AES
	WPA / WPA2 / WPA3-Personal	AES
	WPA / WPA2 / WPA3-Enterprise	AES
	WPA3-Enterprise 192-bit	AES

6 GHz band

Connection method	Authentication	Encryption
Infrastructure	Enhanced Open	AES
	WPA3-Personal	AES
	WPA3-Enterprise	AES
	WPA3-Enterprise 192-bit	AES

Bluetooth

Standards compliance: Bluetooth Specification Version 5.3 compliant (Bluetooth Low Energy technology)

Transmission method: GFSK modulation

- All data above is based on Canon testing standards and CIPA (Camera & Imaging Products Association) testing standards and guidelines.
- Dimensions and weight listed above are based on CIPA Guidelines (except weight for camera body only).
- Product specifications and appearance are subject to change without notice.
- If a problem occurs with a non-Canon lens attached to the camera, contact the respective lens manufacturer.

Trademarks and Licensing

[✔ Trademarks](#)

[✔ About MPEG-4 Licensing](#)

[✔ Accessories](#)

Trademarks

- Adobe is a trademark of Adobe Systems Incorporated.
- Microsoft and Windows are trademarks or registered trademarks of Microsoft Corporation in the United States and/or other countries.
- App Store and macOS are trademarks of Apple Inc., registered in the U.S. and other countries.
- Google Play and Android are trademarks of Google LLC.
- IOS is a trademark or registered trademark of Cisco in the U.S. and other countries and is used under license.
- QR Code is a trademark of Denso Wave Inc.
- SDXC logo is a trademark of SD-3C, LLC.
- CFexpress is a trademark of the CFA (CompactFlash Association).
- The terms HDMI, HDMI High-Definition Multimedia Interface, HDMI Trade dress and the HDMI Logos are trademarks or registered trademarks of HDMI Licensing Administrator, Inc.
- USB Type-C™ and USB-C™ are trademarks of USB Implementers Forum.
- The Bluetooth® word mark and logos are registered trademarks owned by Bluetooth SIG, Inc. and any use of such marks by Canon Inc. is under license. Other trademarks and trade names are those of their respective owners.
- All other trademarks are the property of their respective owners.

About MPEG-4 Licensing

"This product is licensed under AT&T patents for the MPEG-4 standard and may be used for encoding MPEG-4 compliant video and/or decoding MPEG-4 compliant video that was encoded only (1) for a personal and non-commercial purpose or (2) by a video provider licensed under the AT&T patents to provide MPEG-4 compliant video. No license is granted or implied for any other use for MPEG-4 standard."

THIS PRODUCT IS LICENSED UNDER THE AVC PATENT PORTFOLIO LICENSE FOR THE PERSONAL USE OF A CONSUMER OR OTHER USES IN WHICH IT DOES NOT RECEIVE REMUNERATION TO (i) ENCODE VIDEO IN COMPLIANCE WITH THE AVC STANDARD ("AVC VIDEO") AND/OR (ii) DECODE AVC VIDEO THAT WAS ENCODED BY A CONSUMER ENGAGED IN A PERSONAL ACTIVITY AND/OR WAS OBTAINED FROM A VIDEO PROVIDER LICENSED TO PROVIDE AVC VIDEO. NO LICENSE IS GRANTED OR SHALL BE IMPLIED FOR ANY OTHER USE. ADDITIONAL INFORMATION MAY BE OBTAINED FROM MPEG LA, L.L.C. SEE [HTTP://WWW.MPEGLA.COM](http://www.mpegla.com)

* Notice displayed in English as required.

Accessories

Use of genuine Canon accessories is recommended

This product is designed to achieve optimum performance when used with genuine Canon accessories. Therefore, using this product with genuine accessories is highly recommended. Canon shall not be liable for any damage to this product and/or accidents such as malfunction, fire, etc. caused by the failure of non-genuine Canon accessories (e.g., a leakage and/or explosion of a battery). Please note that repairs arising out of the malfunction of non-genuine accessories will not be covered by the warranty for repairs, although you may request such repairs on a chargeable basis.

⚠ Caution

- Battery Pack LP-E6P is dedicated to Canon products only. Using it with an incompatible battery charger or product may result in malfunction or accidents for which Canon cannot be held liable.

Check the following website for details on compatible accessories.

- <https://cam.start.canon/H002/>

